

Metric roller bearing units SYNT and FYNT series (SKF ConCentra)

Bearing types

- Spherical roller bearings

Bearing dimension series

- 222

Shaft diameter range

- 35 to 100 mm

Typical shaft-bearing combinations

- Plain shaft with SKF ConCentra sleeve

Seals

- Double-lip
- Labyrinth
- Heavy-duty

Lubrication

- Grease

Mounting

- Two-bolt mounting
(plummer block housings)
- Three- or four-bolt mounting
(flanged housings)

Materials

- Grey cast iron

Compliance to standards

- ISO 113
(two-bolt plumber block housings)

Supersedes

- SYT series

SKF ConCentra roller bearing units are robust, ready-to-mount units that are assembled, lubricated and sealed at the factory for maximum service life. With their simple and safe installation, easy alignment and reliable locking technology, they are an excellent alternative to sleeve-mounted bearings in split housings.

Metric roller bearing units SYNT and FYNT series (SKF ConCentra)

Designations	661	Condition monitoring	684
Standard bearing unit design	662	SYNT series	684
Concentric locking technology	663	FYNT series	684
Features and benefits	664	Accessories	684
Housing material	665	Ordering information	685
Paint, corrosion protection	665	Product tables	
Dimension standards	665	16.1 SKF ConCentra roller bearing units with a plummer block housing, metric shafts	686
Interchangeability	665	16.2 ConCentra roller bearing units with a flanged housing, metric shafts	688
Bearing unit variants	666		
Sealing solutions	667		
Double-lip seals	667		
Labyrinth seals	667		
Heavy-duty radial shaft seals	667		
End covers	667		
Design considerations	670		
Bearing life	670		
Typical shaft-bearing combinations	670		
Locating and non-locating bearing positions	670		
Load carrying ability	670		
Radial internal clearance	673		
Operating temperature	673		
Operating speed	673		
Shaft specifications	673		
Attachment bolt recommendations	674		
Lubrication	675		
Initial grease fill	675		
Relubrication	675		
Relubrication intervals	676		
Relubrication procedure	678		
Relubrication quantity	679		
Greases for relubrication	679		
Grease life for the relubrication-free variant	680		
Mounting	682		

Designations

Designation system for metric SKF ConCentra roller bearing units

SYNT 45 L W

Series

SYNT Bearing unit with a plummer block housing
FYNT Bearing unit with a flanged housing ¹⁾

Size identification

... Shaft diameter [mm]

Type of arrangement

F Bearing unit for the locating bearing position
L Bearing unit for the non-locating bearing position

Variant

- General (with double-lip seals)
TS High-speed (with labyrinth seals)
TF Extreme environment (with heavy-duty radial shaft seals)
W Relubrication-free (with double-lip seals)

¹⁾ Only available in the general variant.

Designation system for end covers

ECY 211

Series

ECY End cover for SKF ConCentra roller bearing units

Size identification

... Last three digits of the designation of the incorporated bearing

Standard bearing unit design

SKF ConCentra roller bearing units consist of a non-split housing, an SKF spherical roller bearing on an SKF ConCentra stepped sleeve, seals and grease. Bearing units for metric shafts are available in two series, depending on the housing design. Bearing units in the SYNT series have a non-split plummer (pillow) block housing with two holes cast into the base for attachment bolts (→ **fig. 1**). Bearing units in the FYNT series have a flanged housing and are produced in two designs (→ **fig. 2**):

- For shaft diameters from 35 to 60 mm, the housings have a triangular flange and three drilled holes for attachment bolts.
- For shaft diameters from 65 to 100 mm, the housings have a square flange and four drilled holes for attachment bolts.

The bearings used in SKF ConCentra roller bearing units are upgraded SKF Explorer spherical roller bearings in the 222 series. The stepped sleeve has inclined serrations that match the profile of the bearing bore. The bearing unit also contains a mounting collar, washer, back-up collar and wave spring. The mounting collar is equipped with grub (set) screws that are positioned at an angle (not horizontal) to facilitate mounting and dismounting (→ **fig. 3**).

Fig. 1

SYNT series

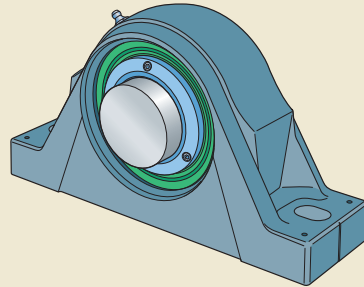
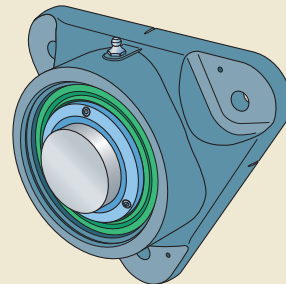
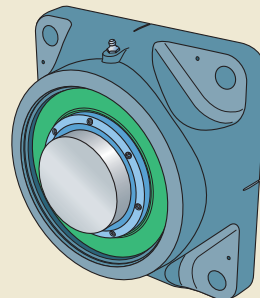

Fig. 2

FYNT series



Shaft diameters from 35 to 60 mm



Shaft diameters from 65 to 100 mm

Concentric locking technology

The locking concept is based on two sets of inclined planes (serrations): one set in the bearing bore, the other on the stepped sleeve. When the grub (set) screws in the mounting collar are tightened, the bearing is displaced axially, forcing the inner ring to expand. This does two things: it sets the correct internal clearance within the bearing and it exerts pressure on the stepped sleeve, forcing it to contract around the circumference of the shaft for a true concentric, tight fit (→ **fig. 4**). When the bearing is displaced axially during mounting, it also pushes against a wave spring. The wave spring, which remains preloaded, facilitates removal of the unit.

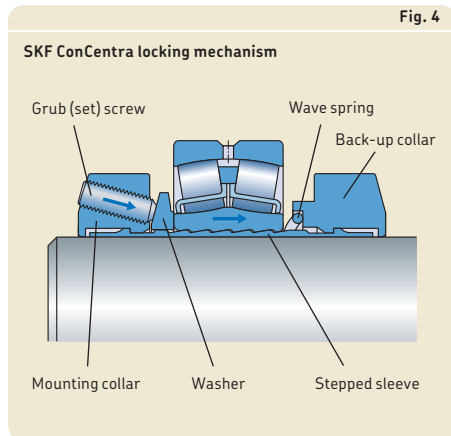
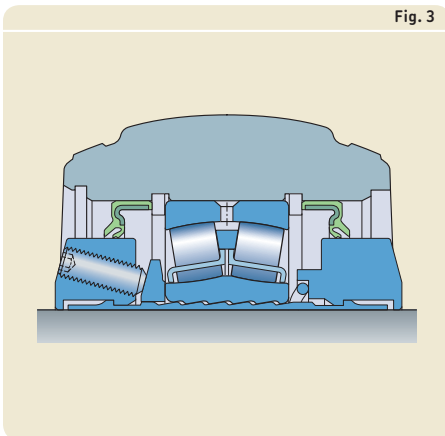

Metric roller bearing units SYNT and FYNT series (SKF ConCentra)

Features and benefits

SKF ConCentra roller bearing units have the following features and benefits:

Ready-to-mount

SKF ConCentra roller bearing units are assembled, greased and ready-to-mount, saving time and reducing the risk of contaminating or damaging the bearing during installation.

Simple mounting

The bearing units can be used with commercial grade shafts and are located easily on the shaft by tightening the grub (set) screws in the mounting collar. To simplify mounting and make alignment more accurate, lines indicating the centre of the bearing seat or the housing bore axis are cast into the housing base or flange. Dimples indicate the position for dowel pins (→ fig. 5).

Concentric locking

Torquing the grub (set) screws to the recommended value sets the internal clearance within the bearing and tightens the sleeve against the shaft. The near perfect 360° grip on the shaft virtually eliminates shaft damage and the possibility of fretting corrosion.

Easy replacement

With SKF ConCentra roller bearing units, logistics costs are reduced as there is only one part to order, store and mount.

Stiff housing

The housing base is reinforced with ribs and the area around the attachment bolt holes is strengthened to minimize the risk of cracking caused by over-tightening the attachment bolts (→ fig. 6).

Optimized for endurance

The upgraded SKF Explorer spherical roller bearings mounted in SKF ConCentra roller bearing units provide a very high load carrying capacity. The special roller profile prevents edge stresses from occurring and the rollers, together with the floating guide ring, keep friction and heat generation to a minimum.

Fig. 5

Cast indications mark the centre of the housing bore or bearing seat

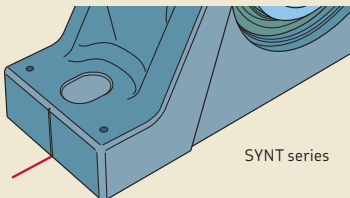

FYNT series

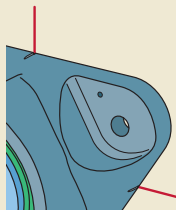
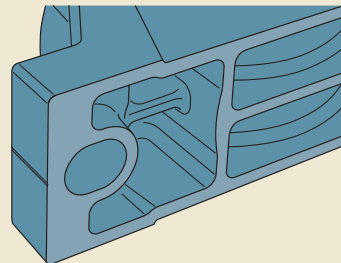

Fig. 6

Reinforcement rib in the base



Housing material

The housings used in SKF ConCentra roller bearing units are made of grey cast iron.

Paint, corrosion protection

The housings are painted black (RAL 9005) using a water based alkyd/acryl paint. The paint protects the housing in accordance with ISO 12944-2, corrosivity category C2 (i.e. exterior atmospheres with low level of pollution, interior atmospheres where condensation may occur). The paint is not affected by most lubricating or engine oils, cutting fluids or alkaline washing chemicals. Housings can be repainted with most water or solvent based 1- or 2-component paints.

Unpainted surfaces are protected by a solventless rust inhibitor.

Dimension standards

Boundary dimensions of SKF ConCentra roller bearing units in the SYNT series are in accordance with ISO 113. Boundary dimensions for bearing units in the FYNT series are not standardized either nationally or internationally.

Interchangeability

SKF ConCentra roller bearing units in the SYNT series are dimensionally interchangeable with SNL plummer (pillow) block housings in the 5(00) series (→ *Split plummer block housings SNL 2, 3, 5 and 6 series*, starting on **page 55**).

Bearing units in the FYNT series are dimensionally interchangeable with FNL flanged housings (→ *Flanged housings FNL series*, starting on **page 531**).

Bearing unit variants

SKF ConCentra roller bearing units are available in four variants, each optimized to accommodate certain application conditions. Bearing units in the SYNT series are available in all four variants. Bearing units in the FYNT series are only available in the general variant.

With the exception of the relubrication-free variant, SKF ConCentra roller bearing units are filled with a premium lithium grease that contains EP additives. Relubrication-free bearing units are filled with a premium semi-synthetic long-life grease.

For additional information about the sealing solution and grease used in the different variants, refer to the sections *Sealing solutions* (→ page 667) and *Lubrication* (→ page 675) respectively.

General variant

These bearing units are equipped with a double-lip seal on each side. They are suitable for normal to heavy loads ($0,05 C < P \leq 0,15 C^1$) in contaminated environments, e.g. textile machines.

High-speed variant

These bearing units are equipped with a labyrinth seal on each side. They are suitable for normal to heavy loads ($0,05 C < P \leq 0,15 C^1$) in relatively clean to normal environments, e.g. industrial fans and blowers.

Bearing units in the high-speed variant are identified by the designation suffix TS.

Extreme environment variant

These bearing units are equipped with a heavy-duty radial shaft seal on each side. They are suitable for normal to heavy loads ($0,05 C < P \leq 0,15 C^1$) in extremely contaminated environments, e.g. outdoor conveyors.

Bearing units in the extreme environment variant are identified by the designation suffix TF.

Relubrication-free variant

These bearing units are equipped with a double-lip seal on each side. They are suitable for light loads ($P \leq 0,05 C^1$) in relatively clean environments, e.g. industrial air handling units.

Bearing units in the relubrication-free variant are identified by the designation suffix W.

¹⁾ The basic dynamic load rating C is provided in the product tables. To calculate the equivalent dynamic bearing load P, refer to page 678.

Sealing solutions

SKF ConCentra roller bearing units in the SYNT series are available with different sealing solutions (→ **fig. 7**):

- double-lip seals
- labyrinth seals
- heavy-duty radial shaft seals
- end covers

Bearing units in the FYNT series are produced standard with double-lip seals. End covers are also available, but must be ordered separately.

Table 1, page 668 provides an overview of the characteristics and suitability of each sealing solution. Details are provided in the following text. This information should be used as a guideline, and does not substitute for testing a seal in its application.

Double-lip seals

Double-lip seals are made of acrylonitrile-butadiene rubber (NBR) that is vulcanized onto a stamped steel insert. The steel insert enables the outside surface of the seal to sit firmly in the housing bore, providing a static seal. The seal has an auxiliary lip to protect against coarse contaminants.

Labyrinth seals

As labyrinth seals do not generate friction, bearing units fitted with these seals are cap-

able of relatively high speed operation. The labyrinth is created with three sheet steel rings. Two rings are fixed to the mounting collar / back-up collar. Both rotate with the shaft to act as flingers. The third ring is secured in the housing bore.

Heavy-duty radial shaft seals

Heavy-duty radial shaft seals with an auxiliary lip provide superior protection against contaminants. These rugged and robust seals have a steel insert that is encased in acrylonitrile-butadiene rubber (NBR). The primary seal lip is spring loaded and can maintain its sealing ability even if there is excessive wear. An auxiliary dust lip provides added protection against coarse contaminants.

End covers

Bearing units mounted at the end of a shaft should have an end cover. These are made of plastic and can be snapped easily into the recess of the housing bore.

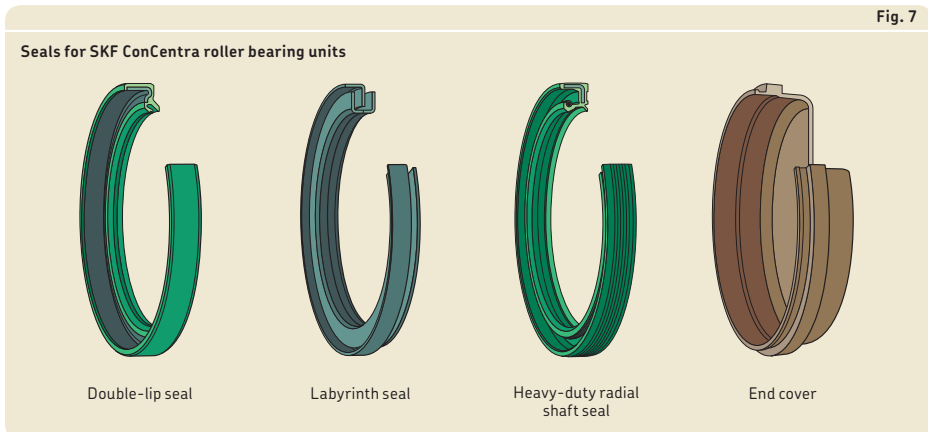

Details of the permissible length of the shaft end are provided in **table 2** on **page 669**.



Metric roller bearing units SYNT and FYNT series (SKF ConCentra)

Table 1

Seals for SKF ConCentra roller bearing units

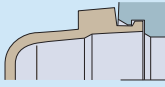
Seal				
Type	double-lip	labyrinth	heavy-duty radial shaft seal	end cover
Variant	general and relubrication-free	high-speed	extreme environment	all
Housing series	SYNT FYNT – general variant only	SYNT	SYNT	SYNT and FYNT
Material	nitrile rubber, steel	steel	nitrile rubber, steel	polypropylene
Application conditions and requirements				
Temperature [°C]	-20 to 110 ¹⁾	-20 to 110 ¹⁾	-20 to 110 ¹⁾	-20 to 110 ¹⁾
Temperature [°F]	-5 to 230 ¹⁾	-5 to 230 ¹⁾	-5 to 230 ¹⁾	-5 to 230 ¹⁾
Max. circumferential speed ²⁾ [m/s]	13	not limited	6	n/a
Max. misalignment [°]	1,5	1,5	1,5	n/a
Low friction	+	++	+	n/a
Axial shaft displacement	++	-	+	n/a
Vertical shaft arrangement	+	+	+	+
Sealing suitability				
Dust	++	-	++	++
Fine particles	++	-	++	++
Coarse particles	++	+	++	++
Chips	+	++	++	++
Liquids when sprayed	+	--	++	++
Direct sunlight	+	++	+	++
Symbol:	n/a not applicable ++ very suitable + suitable - limited suitability -- unsuitable			

¹⁾ Imposed by the grease.

²⁾ To convert circumferential speeds to rotational speeds, refer to **table 7** on **page 37**.

Table 2

Permissible length of the shaft end

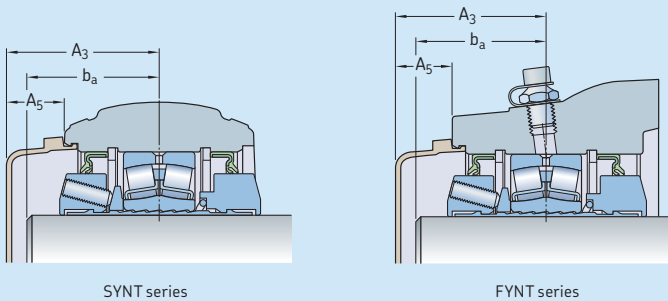

Bearing unit Size		Dimensions		A_3	A_5
		b_a min.	max.		
mm					
SYNT 35	FYNT 35	34	43	50	22
SYNT 40	FYNT 40	34	43	51	23,5
SYNT 45	FYNT 45	34	43	52	23
SYNT 50	FYNT 50	34	55	62	29,5
SYNT 55	FYNT 55	34	55	66	34
SYNT 60	FYNT 60	38	65	73	35,5
SYNT 65	FYNT 65	38	65	73	35,5
SYNT 70	FYNT 70	38	70	80	38,5
SYNT 75	FYNT 75	38	70	80	38,5

Design considerations

For general information about system design, refer to the following sections:

- *Typical shaft-bearing combinations* (→ **page 41**)
- *Locating/non-locating bearing systems* (→ **page 40**)
- *Load carrying ability* (→ **page 44**)
- *Specifications for shafts and housing support surfaces* (→ **page 45**)

Bearing life

For information about the SKF rating life, minimum load and static safety for bearings in SKF ConCentra roller bearing units, refer to the product information available online at skf.com/bearings. The bearing designations and load carrying capacities are provided in the product tables, starting on **page 686**.

Typical shaft-bearing combinations

SKF ConCentra roller bearing units accommodate bearings on an SKF ConCentra stepped sleeve (with inclined serrations) on plain shafts.

Locating and non-locating bearing positions

SKF ConCentra roller bearing units can be used for both the locating and non-locating bearing positions. Bearing units for the non-locating bearing position have a wide bearing seat to accommodate 2,5 mm of axial displacement, in either direction, from the central position (→ **fig. 8**). Units for the non-locating bearing position are identified by the designation suffix L.

Bearing units for the locating bearing position are identified by the designation suffix F.

Load carrying ability

SKF ConCentra roller bearing units are intended for loads acting perpendicularly toward the support surface. If the bearing unit is supported over its entire base and the loads are purely perpendicular, loads are limited only by the bearing. If loads acting in other

directions occur, or if the bearing unit is not supported over its entire base, be sure that the magnitude of the load is permissible for the housing and the attachment bolts. If heavy loads, not acting perpendicularly toward the support surface, are expected, additional supports are recommended to relieve the attachment bolts of the load.

Breaking loads and safety factors

Guideline values for the breaking loads of housings in the SYNT series are listed in **table 3**. Guideline values for the breaking loads of housings in the FYNT series are listed in **table 4, page 672**. To obtain the permissible load for a housing, the appropriate breaking load should be divided by a factor based on the safety requirements. In general engineering, a safety factor of 6 is typical (→ *Load carrying ability, page 44*).

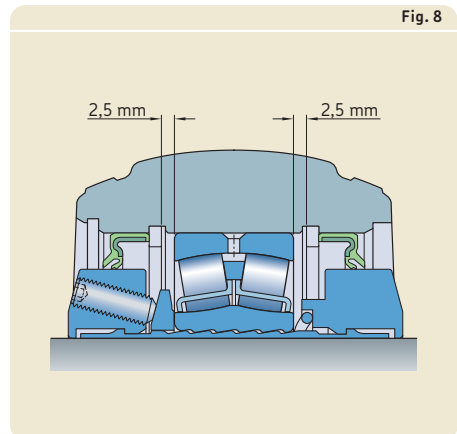
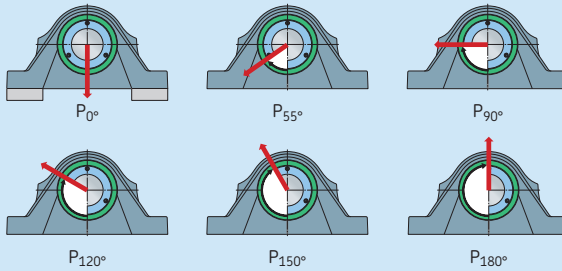

Table 3

Breaking loads for housings of SKF ConCentra roller bearing units in the SYNT series



Bearing unit Size	Breaking load in the direction of P_{0° ¹⁾					
	P_{55°	P_{90°	P_{120°	P_{150°	P_{180°	
–	kN					
SYNT 35	150	250	150	95	85	105
SYNT 40	160	265	160	100	90	110
SYNT 45	170	280	170	110	100	115
SYNT 50	190	330	200	130	115	140
SYNT 55	210	350	210	140	120	150
SYNT 60	270	365	220	150	130	170
SYNT 65	290	380	230	155	140	210
SYNT 70	350	400	240	160	145	215
SYNT 75	370	415	250	165	150	220
SYNT 80	430	480	290	205	190	240
SYNT 90	470	620	370	280	250	310
SYNT 100	600	680	410	310	275	340

¹⁾ The values for P_{0° are valid when the housing is not fully supported across its base.

Metric roller bearing units SYNT and FYNT series (SKF ConCentra)

Axial holding power

The axial holding power of an SKF ConCentra roller bearing unit depends on the friction between the shaft and stepped sleeve. It is therefore also dependent on the number of grub (set) screws in the mounting collar (→ table 5).

When mounted correctly, the bearing units can withstand typical shock loads equivalent to the requisite axial holding force. However, the maximum operating axial load is limited by the rated bearing life through the equivalent bearing load P (→ page 678).

Table 5

Axial holding power of SKF ConCentra roller bearing units			
Bearing unit Size		No. of grub (set) screws	Axial holding power ¹⁾
–		–	kN
SYNT 35	FYNT 35	3	15
SYNT 40	FYNT 40	3	15
SYNT 45	FYNT 45	3	15
SYNT 50	FYNT 50	3	15
SYNT 55	FYNT 55	3	15
SYNT 60	FYNT 60	3	15
SYNT 65	FYNT 65	4	20
SYNT 70	FYNT 70	4	20
SYNT 75	FYNT 75	5	25
SYNT 80	FYNT 80	5	25
SYNT 90	FYNT 90	7	35
SYNT 100	FYNT 100	7	35

¹⁾ Not equivalent to the axial load carrying capacity of the bearing unit

Table 4

Breaking loads for housings of SKF ConCentra roller bearing units in the FYNT series

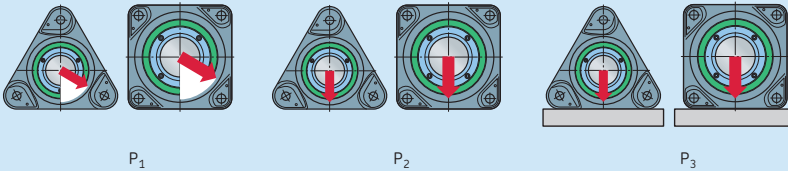

Bearing unit Size	Breaking load in the direction of		
	P ₁	P ₂	P ₃
–	kN		
FYNT 35	80	55	95
FYNT 40	90	60	100
FYNT 45	100	65	105
FYNT 50	110	80	110
FYNT 55	120	95	115
FYNT 60	130	110	190
FYNT 65	140	125	265
FYNT 70	150	140	340
FYNT 75	160	155	415
FYNT 80	170	170	490
FYNT 90	180	185	565
FYNT 100	190	200	640

Additional housing support for bearing units in the SYNT series

When the housing is subjected to loads acting parallel to the support surface, it may be necessary to pin the housing to the support surface or to provide a stop to counter the load.

In cases where the resultant radial load is between 55° and 120° or when the axial load is greater than 5% of P_{180° (→ **table 3, page 671**), the bearing unit should be pinned to its support surface. The dowel pins should be sufficiently strong to accommodate the loads acting parallel to the support surface.

Recommendations for the position and size of the holes to accommodate dowel pins are provided in **table 12 on page 683**.

Radial internal clearance

The upgraded SKF Explorer spherical roller bearings in SKF ConCentra roller bearing units are manufactured standard with C3 radial internal clearance. The clearance values, in accordance with ISO 5753-1, are provided in **table 6** and are valid for unmounted bearings under zero measuring load.

Operating temperature

The permissible operating temperature of SKF ConCentra roller bearing units is limited by the lubricant (→ **table 8, page 675**). For relubrication-free units, refer to the section *Grease*

life for the relubrication-free variant on page 680.

The housing material does not have any additional temperature limits, except for very low temperature applications where impact strength could be a factor.

The housing paint is heat resistant up to 80 °C (175 °F) material temperature or 100 °C (210 °F) ambient temperature.

Operating speed

The speeds at which SKF ConCentra roller bearing units can be operated depend on the sealing solution in the bearing unit. For bearing units fitted with double-lip or heavy-duty radial shaft seals, the limiting speeds are based on the permissible circumferential speed at the seal lips. For those fitted with labyrinth seals, the limiting speeds are imposed by the bearing size and the grease.

Guideline values for the limiting speeds are listed in the product tables.

Shaft specifications

SKF ConCentra roller bearing units can be used with commercial grade shafts that meet the h9 \oplus tolerance class for dimensional accuracy and an IT5/2 tolerance for cylindricity, in accordance with ISO 1101.

Table 6

Radial internal clearance of bearings in SKF ConCentra roller bearing unit.

Bore diameter d		Radial internal clearance	
over	incl.	min.	max.
mm		μm	
30	40	50	65
40	50	60	80
50	65	75	95
65	80	95	120
80	100	110	140

Attachment bolt recommendations

In typical applications, 8.8 class hexagon head bolts in accordance with ISO 4014 can be used together with washers. If the load does not act perpendicularly toward the base or is particularly heavy, it may be necessary to use stronger, 10.9 class bolts.

SKF housings can withstand loads resulting from tightening the attachment bolts to the torque values recommended by bolt manufacturers (→ **table 7**). They are valid for oiled, but otherwise untreated, thread surfaces.

SKF cannot guarantee that tightening to the recommended value will provide sufficient anchoring. Make sure that attachment bolts, dowels or stops, and a sufficiently strong support can accommodate all occurring loads.

Table 7

Torque values for attachment bolts		
Bearing unit Size	Attachment bolts Size	Tightening torque ¹⁾
–	–	Nm
SYNT 35	M 12	80
SYNT 40	M 12	80
SYNT 45	M 12	80
SYNT 50	M 16	200
SYNT 55	M 16	200
SYNT 60	M 16	200
SYNT 65	M 16	200
SYNT 70	M 20	385
SYNT 75	M 20	385
SYNT 80	M 20	385
SYNT 90	M 24	665
SYNT 100	M 24	665
FYNT 35	M 12	80
FYNT 40	M 12	80
FYNT 45	M 12	80
FYNT 50	M 12	80
FYNT 55	M 12	80
FYNT 60	M 12	80
FYNT 65	M 16	200
FYNT 70	M 16	200
FYNT 75	M 16	200
FYNT 80	M 16	200
FYNT 90	M 20	385
FYNT 100	M 20	385

¹⁾ Recommended by bolt manufacturers.

Lubrication

SKF ConCentra roller bearing units are intended for grease lubrication.

Initial grease fill

SKF ConCentra roller bearing units in the general, high-speed and extreme environment variants are filled with a mineral oil based lithium grease. The initial grease fill at the factory fills the bearing completely, and 30 to 50% of the free space in the housing.

Relubrication-free bearing units are filled with a semi-synthetic oil based lithium grease. The initial grease fill at the factory fills the bearing completely, and 60 to 80% of the free space in the housing.

The technical specifications of both greases are provided in **table 8**.

Relubrication

SKF ConCentra roller bearing units are typically relubricated in order to realize maximum service life. All bearing units have a lubrication hole with a 1/8-27 NPSF thread. They are provided standard with a grease fitting AH 1/8-27 PTF, except for the relubrication-free variant, which has the lubrication hole plugged.

Table 8

Technical specifications for the greases in SKF ConCentra roller bearing units

Housing variant	Temperature range	Thickener	Base oil type	NLGI consistency class	Base oil viscosity [mm ² /s]	
					at 40 °C (105 °F)	at 100 °C (210 °F)
General, high-speed and extreme temperature	-20 to 110 °C (-5 to 230 °F)	Lithium soap	Mineral	2	200	13
Relubrication-free	-30 to 120 °C (-20 to 250 °F)	Lithium soap	Semi-synthetic	2-3	41,9	7,5

Relubrication intervals

The relubrication interval t_f for SKF ConCentra roller bearing units excluding the relubrication-free variant can be obtained from **diagrams 1 to 3** as a function of:

- the operating temperature
- the rotational speed n [r/min]
- the bearing mean diameter d_m [mm]
(→ **table 9, page 678**)
- the bearing factor b_f (→ **table 9, page 678**, for values of e)
 - $b_f = 2$ when $F_a/F_r \leq e$
 - $b_f = 6$ when $F_a/F_r > e$
- the load ratio
 - $P \leq 0,05 C$ (→ **diagram 1**)
 - $P = 0,1 C$ (→ **diagram 2**)
 - $P = 0,15 C$ (→ **diagram 3**)

Diagram 1

Relubrication interval t_f for roller bearing units, for $P \leq 0,05 C$

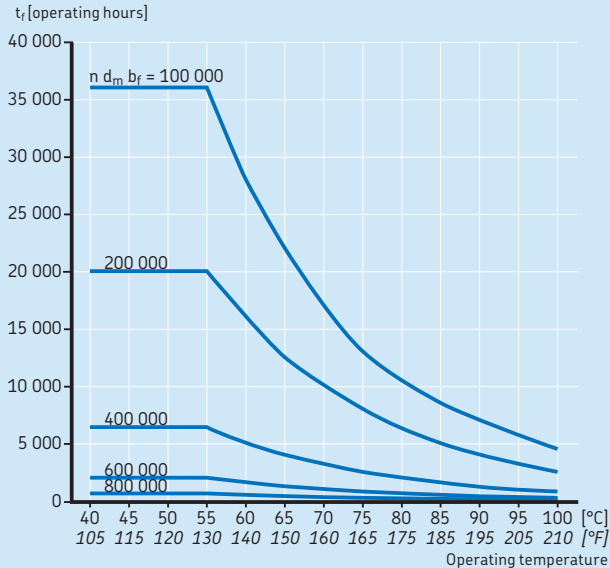

Diagram 2

Relubrication interval t_r for roller bearing units, for $P = 0,1 C$

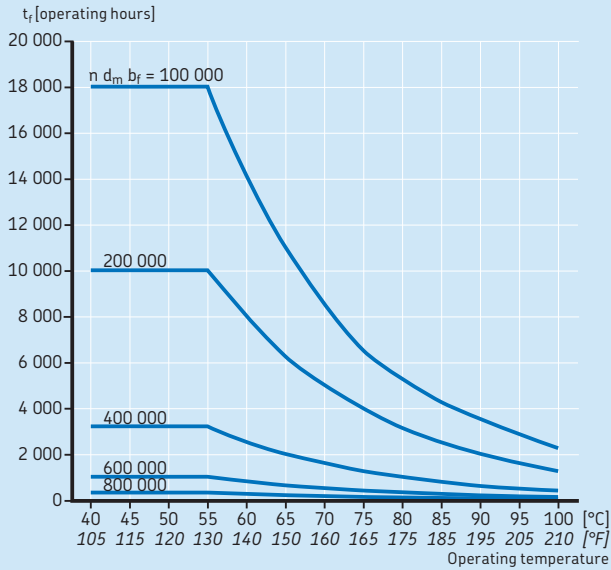
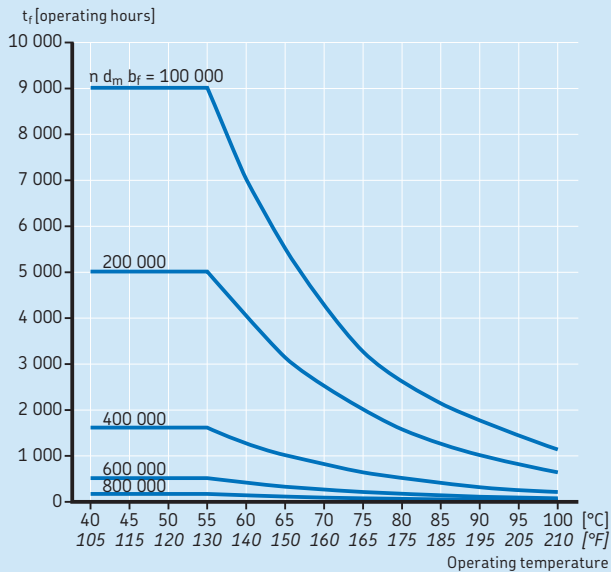

Diagram 3

Relubrication interval t_r for roller bearing units, for $P = 0,15 C$



Metric roller bearing units SYNT and FYNT series (SKF ConCentra)

The basic dynamic load rating C is provided in the product tables. The equivalent dynamic bearing load P can be obtained from

$$P = F_r + Y_1 F_a \quad \text{when } F_a/F_r \leq e$$

$$P = 0,67F_r + Y_2 F_a \quad \text{when } F_a/F_r > e$$

where

- P = equivalent dynamic bearing load [kN]
 F_r = radial component of the bearing load [kN]
 F_a = axial component of the bearing load [kN]
 Y_1, Y_2 = axial load calculation factors for the bearing (→ **table 9**)
 e = limiting value for F_a/F_r (→ **table 9**)

The calculated relubrication intervals represent the grease life L_1 , which relates to the time period at the end of which 99% of the bearing units are still reliably lubricated. The intervals are estimated values, applicable for bearing units mounted on horizontal shafts in a relatively clean environment. When operating conditions differ, the relubrication intervals should be adjusted as follows:

- For a vertical shaft, the interval should be halved.
- For outer ring rotation or rotating load, the interval should be halved.
- For contaminated environments, the following reduction factors should be used:
 - 0,5 for moderate contamination
 - 0,3 for severe contamination
 - 0,1 for very severe contamination

Relubrication procedure

Before relubricating, the grease fitting and the area surrounding it should be cleaned. High-pressure cleaning equipment should be avoided. During relubrication, grease should be introduced via the grease fitting (→ **fig. 9**) while the shaft is rotating slowly. Excessive pressure and over-greasing should be avoided, otherwise the seals may be damaged.

Table 9

Bearing mean diameter and calculation factors for SKF ConCentra roller bearing units

Bearing unit		Bearing mean diameter d_m mm	Calculation factors		
Size			e	Y_1	Y_2
–		–	–	–	–
SYNT 35	FYNT 35	53,5	0,31	2,2	3,3
SYNT 40	FYNT 40	60	0,28	2,4	3,6
SYNT 45	FYNT 45	65	0,26	2,6	3,9
SYNT 50	FYNT 50	70	0,24	2,8	4,2
SYNT 55	FYNT 55	77,5	0,24	2,8	4,2
SYNT 60	FYNT 60	85	0,24	2,8	4,2
SYNT 65	FYNT 65	92,5	0,24	2,8	4,2
SYNT 70	FYNT 70	97,5	0,22	3,0	4,6
SYNT 75	FYNT 75	102,5	0,22	3,0	4,6
SYNT 80	FYNT 80	110	0,22	3,0	4,6
SYNT 90	FYNT 90	125	0,24	2,8	4,2
SYNT 100	FYNT 100	140	0,24	2,8	4,2

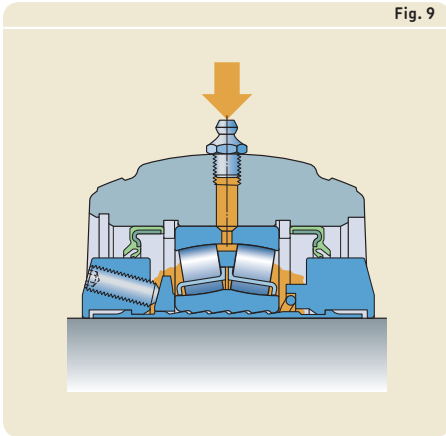

Relubrication quantity

The appropriate quantity of grease for relubrication of SKF ConCentra roller bearing units is provided in **table 10**.

Greases for relubrication

To relubricate SKF ConCentra roller bearing units, SKF recommends using SKF LGEP 2 grease, which is fully compatible with the original grease introduced at the factory. Other compatible greases such as SKF's multi-purpose LGMT 2 and LGMT 3 greases can also be used.

Table 10

Grease quantities for relubrication of SKF ConCentra roller bearing units

Bearing unit Size	Grease quantity
–	g
SYNT 35 FYNT 35	3
SYNT 40 FYNT 40	4
SYNT 45 FYNT 45	4
SYNT 50 FYNT 50	4
SYNT 55 FYNT 55	5
SYNT 60 FYNT 60	6
SYNT 65 FYNT 65	7
SYNT 70 FYNT 70	8
SYNT 75 FYNT 75	8
SYNT 80 FYNT 80	9
SYNT 90 FYNT 90	13
SYNT 100 FYNT 100	17

Grease life for the relubrication-free variant

The grease used in relubrication-free bearing units can adequately lubricate the bearing throughout its service life provided the bearing unit is suitable for the operating conditions. The relationship between operating conditions and grease service life is shown in **diagram 4** and is a function of:

- the operating temperature [$^{\circ}\text{C}$]
- the speed factor $A = n d_m$

where

A = speed factor [mm/min]

n = rotational speed [r/min]

d_m = bearing mean diameter [mm]

(→ **table 9, page 678**)

Provided the operating range of the bearing unit falls within the shaded area of **diagram 4**, the bearing unit can attain a grease life of $L_{50h} = 100\,000$ hours or more. L_{50h} is the time period at the end of which 50% of the units are still reliably lubricated.

Calculation example

An SKF ConCentra roller bearing unit with a plummer block housing is required for an industrial air handling unit. The following application information is known:

- required grease life $L_{50h} = 100\,000$ hours
- equivalent dynamic bearing load $P = 7$ kN
- rotational speed $n = 1\,800$ r/min
- shaft diameter $d_a = 60$ mm
- environmental conditions: relatively clean
- expected operating temperature: 55°C

Based on the shaft diameter provided and the plummer block housing requirement, the SYNT 60 bearing unit is selected. As the application is an industrial air handling unit in a relatively clean environment, the relubrication-free variant would be a suitable choice.

From the product table, the basic dynamic load rating $C = 156$ kN and

$$\text{when } C/P = 156/7 = 22,3$$

$$\text{then } P = 0,045 C$$

Therefore, the bearing unit meets the conditions of use for relubrication-free variants, where $P \leq 0,05 C$.

For $d_m = 85$ mm (→ **table 9, page 678**)

$$A = n d_m = 1\,800 \times 85 = 153\,000 \text{ mm/min}$$

Using **diagram 4**, the intersection point of the calculated speed factor and expected operating temperature of 55°C is located in the shaded area.

The SYNT 60 FW (or SYNT 60 LW) bearing unit meets the grease life requirement and is therefore suitable for the application.

Diagram 4

Temperature-speed relationship for relubrication-free SKF ConCentra roller bearing units

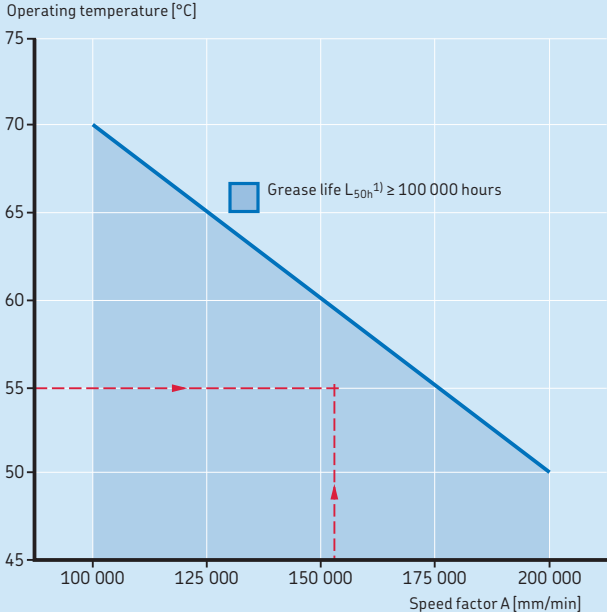

¹⁾ Grease life at 50% reliability

Mounting

SKF ConCentra roller bearing units must be mounted properly using the appropriate tools and state of the art mechanical mounting methods. All the associated components must also meet certain basic requirements (→ *Specifications for shafts and housing support surfaces on page 45*).

The mounting collar of bearing units in the SYNT and FYNT series is equipped with M6 grub (set) screws, the number of which depends on the size of the bearing unit. SKF recommends using a torque wrench to tighten these grub (set) screws. The tightening torque is 8 Nm.

CAUTION: Do not tighten the grub (set) screws until the bearing unit is positioned on the shaft. If the screws are tightened prematurely, the stepped sleeve may deform.

Table 11

Position and size of dowel pin holes for SKF ConCentra roller bearing units in the FYNT series

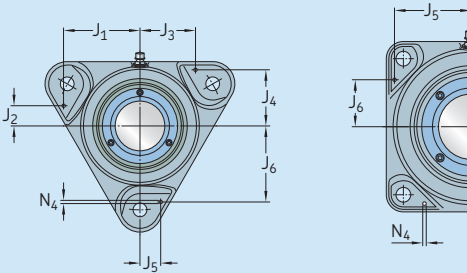

Bearing unit Size	Dimensions						
	J ₁	J ₂	J ₃	J ₄	J ₅	J ₆	N ₄ max.
–	mm						
FYNT 35	65	17	48	38,5	16	66	6
FYNT 40	71	20	53	43	18	72	6
FYNT 45	71	20	53	45,5	18	72	6
FYNT 50	77	21	57	49	21	77	6
FYNT 55	84	22	62	54,5	22	84	8
FYNT 60	90	24	66	59,5	24	90	8
FYNT 65	–	–	–	–	85	55	8
FYNT 70	–	–	–	–	87	54	8
FYNT 75	–	–	–	–	93	63	8
FYNT 80	–	–	–	–	95	60	8
FYNT 90	–	–	–	–	112	72	8
FYNT 100	–	–	–	–	122	78	8

Attaching bearing units in the FYNT series to a machine wall

Bearing units in the FYNT series are produced standard with a machined recess, which can be used to centre the housing on a shoulder. With this arrangement, the attachment bolts are not subjected to shear forces. The shoulder can be provided either by machining the wall or by attaching a guide ring to the wall. The dimensions of the recess D_a , are provided in **product table 16.2** on **page 688**.

Dowel pins can also be used where necessary. Recommendations for the position and size of the holes to accommodate dowel pins are provided in **table 11**.

Pinning or supporting bearing units in the SYNT series

Some load conditions may require the housing to be pinned to its support surface or to provide a stop to accommodate loads acting parallel to the support surface (→ *Additional housing support for bearing units in the SYNT series* on **page 673**). Recommendations for the position and size of the holes to accommodate dowel pins are provided in **table 12**.

Table 12

Position and size of dowel pin holes for SKF ConCentra roller bearing units in the SYNT series

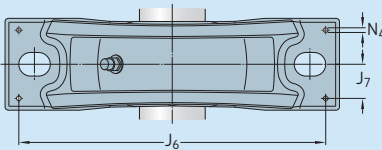

Bearing unit Size	Dimensions		
	J_6	J_7	N_4 max.
mm			
SYNT 35	135	23	6
SYNT 40	135	23	6
SYNT 45	135	23	6
SYNT 50	170	27	8
SYNT 55	172	27	8
SYNT 60	190	32	8
SYNT 65	190	32	8
SYNT 70	218	35	8
SYNT 75	218	35	8
SYNT 80	320	35	8
SYNT 90	355	40	8
SYNT 100	385	45	8

Condition monitoring

SYNT series

SKF ConCentra roller bearing units in the SYNT series are prepared for condition monitoring as they have three flat surfaces cast into the housing (→ **fig. 10**).

Positions 1 and 3 are perpendicular to the shaft, and should be used when the unit is hung from its support or when the load acts away from or toward the support surface.

Position 2 is a measurement point parallel to the shaft and should be used when axial loads occur.

FYNT series

Accelerometers with magnets that can accommodate rounded surfaces can be attached to bearing units in the FYNT series (→ **fig. 11**).

Position 1 (360° surface area) is perpendicular to the shaft, and should be used when the load acts away from or toward the support surface.

Position 2 (360° surface area) is parallel to the shaft and should be used when axial loads occur.

Accessories

The following accessories are available for SKF ConCentra roller bearing units:

- Adapter for G 1/4 connections: LAPN 1/8
- Automatic lubricator: SKF SYSTEM 24
- Grease meter: LAGM 1000E
- Condition monitoring sensors

For additional information, refer to *SKF tools and products* (→ **page 47**).

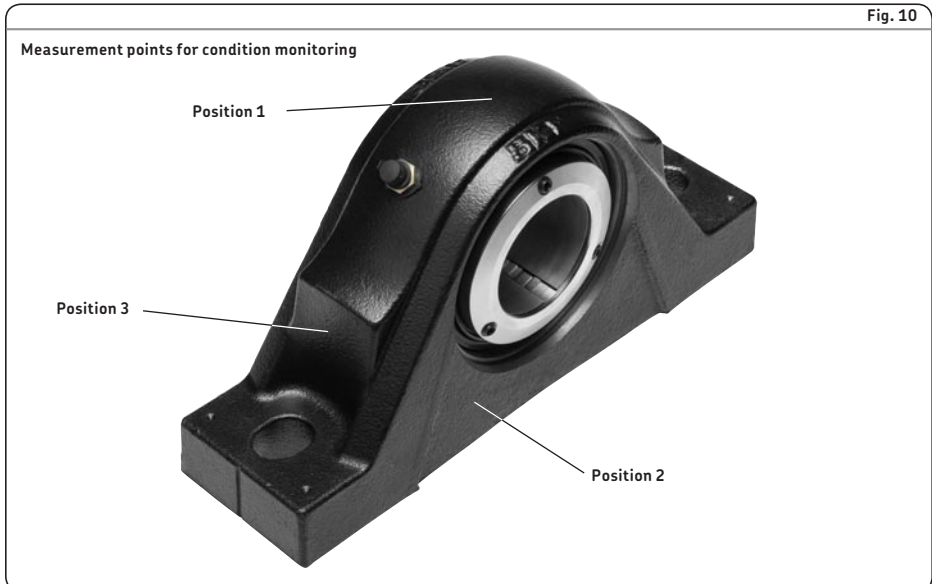

Ordering information

SKF ConCentra roller bearing units are supplied assembled, greased and ready-to-mount. End covers must be ordered separately.

Order example

Two SKF ConCentra roller bearing units with a plummer block housing are required for a 50 mm shaft diameter. One bearing unit will accommodate the bearing in the non-locating position at the end of the shaft. The other bearing unit will accommodate the bearing in the locating position and a through shaft. The bearing units should be relubrication-free.

The following items should be ordered:

- 1 bearing unit SYNT 50 FW
- 1 bearing unit SYNT 50 LW
- 1 end cover ECY 210



16.1 SKF ConCentra roller bearing units with a plummer block housing, metric shafts

d_a 35 – 100 mm

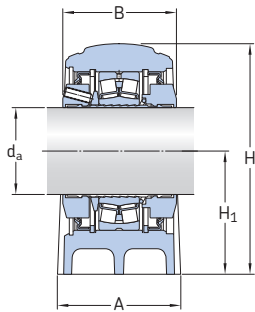

General variant

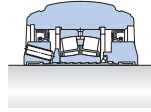

Extreme environment variant
Designation suffix TF

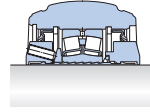

Relubrication-free variant
Designation suffix W



High-speed variant
Designation suffix TS

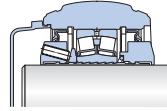

End cover

Shaft diameter d_a	Bearing unit Designation ¹⁾ Locating	Non-locating	Bearing Designation	Basic load ratings		Fatigue load limit	End cover Designation
				dynamic	static		
mm	–	–	–	C	C_0	P_u	–
35	SYNT 35 F	SYNT 35 L	22207 E	86,5	85	9,3	ECY 207
40	SYNT 40 F	SYNT 40 L	22208 E	96,5	90	9,8	ECY 208
45	SYNT 45 F	SYNT 45 L	22209 E	102	98	10,8	ECY 209
50	SYNT 50 F	SYNT 50 L	22210 E	104	108	11,8	ECY 210
55	SYNT 55 F	SYNT 55 L	22211 E	125	137	13,7	ECY 211
60	SYNT 60 F	SYNT 60 L	22212 E	156	166	18,6	ECY 212
65	SYNT 65 F	SYNT 65 L	22213 E	193	216	24	ECY 213
70	SYNT 70 F	SYNT 70 L	22214 E	208	228	25,5	ECY 214
75	SYNT 75 F	SYNT 75 L	22215 E	212	240	26,5	ECY 215
80	SYNT 80 F	SYNT 80 L	22216 E	236	270	29	–
90	SYNT 90 F	SYNT 90 L	22218 E	325	375	39	–
100	SYNT 100 F	SYNT 100 L	22220 E	425	490	49	–

¹⁾ General variant. (For other variants, the appropriate designation suffix should be added.)

²⁾ Also refer to **diagram 4** on **page 681**.

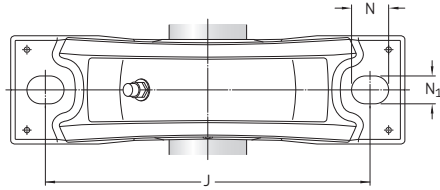
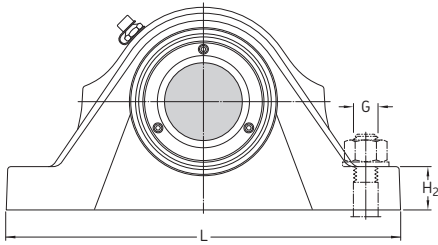

Shaft diameter d_a	Limiting speeds of unit variants				Dimensions Bearing unit										Mass Unit
	General	High-speed	Extreme environment	Relubrication-free ²⁾	A	B	H	H ₁	H ₂	J	L	N	N ₁	G	
mm	r/min				mm										kg
35	4 100	6 500	2 050	4 100	60	65	111	60	25	170	205	20	15	12	3,8
40	3 800	5 900	1 900	3 800	60	65	114	60	25	170	205	20	15	12	3,8
45	3 500	5 400	1 750	3 500	60	65	118	60	25	170	205	20	15	12	4
50	3 300	4 900	1 650	3 300	70	65	131	70	28	210	255	24	18	16	5,8
55	3 100	4 500	1 550	3 100	70	66	137	70	30	210	255	24	18	16	6
60	2 900	4 100	1 450	2 900	80	71	151	80	30	230	275	24	18	16	7,7
65	2 700	3 800	1 350	2 700	80	72	158	80	30	230	280	24	18	16	8,7
70	2 600	3 600	1 300	2 600	90	72	176	95	32	260	315	28	22	20	11
75	2 500	3 300	1 250	2 500	90	72	180	95	32	260	320	28	22	20	12
80	2 300	3 100	1 150	2 300	100	72	191	100	35	290	345	28	22	20	20
90	2 100	2 800	1 050	2 100	110	86	216	112	40	320	380	32	26	24	21
100	2 000	2 500	1 000	2 000	120	86	238	125	45	350	410	32	26	24	26

16.2 SKF ConCentra roller bearing units with a flanged housing, metric shafts d_a 35 – 100 mm

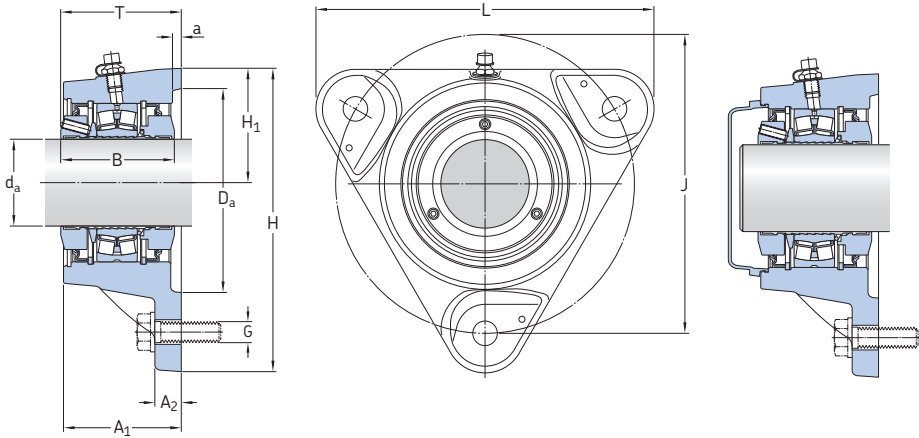

Housing design for shaft diameters 35 to 60 mm

End cover

Shaft diameter d _a	Bearing unit		Bearing Designation	Basic load ratings		Fatigue load limit P _u	Limiting speed r/min	End cover Designation
	Designation Locating	Non-locating		dynamic	static			
mm	–	–	–	kN	C ₀	kN	–	–
35	FYNT 35 F	FYNT 35 L	22207 E	86,5	85	9,3	4 100	ECY 207
40	FYNT 40 F	FYNT 40 L	22208 E	96,5	90	9,8	3 800	ECY 208
45	FYNT 45 F	FYNT 45 L	22209 E	102	98	10,8	3 500	ECY 209
50	FYNT 50 F	FYNT 50 L	22210 E	104	108	11,8	3 300	ECY 210
55	FYNT 55 F	FYNT 55 L	22211 E	125	137	13,7	3 100	ECY 211
60	FYNT 60 F	FYNT 60 L	22212 E	156	166	18,6	2 900	ECY 212
65	FYNT 65 F	FYNT 65 L	22213 E	193	216	24	2 700	ECY 213
70	FYNT 70 F	FYNT 70 L	22214 E	208	228	25,5	2 600	ECY 214
75	FYNT 75 F	FYNT 75 L	22215 E	212	240	26,5	2 500	ECY 215
80	FYNT 80 F	FYNT 80 L	22216 E	236	270	29	2 300	–
90	FYNT 90 F	FYNT 90 L	22218 E	325	375	39	2 100	–
100	FYNT 100 F	FYNT 100 L	22220 E	425	490	49	2 000	–

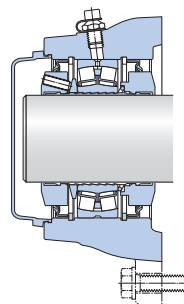
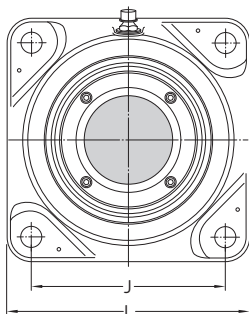
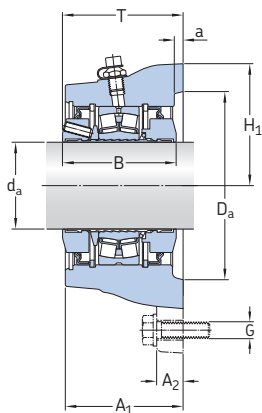

Housing design for shaft diameters 65 to 100 mm

End cover

Shaft diameter	Dimensions			B	H	H ₁	J	L	G	D _a	a	Mass Unit
	Bearing unit											
d _a	A ₁	A ₂	T max.									
mm	mm											kg
35	66	12	72,5	65	143	54	140	159	12	90	4	3
40	66	12	72,5	65	160	60	160	179	12	100	4	3,6
45	66	15	72,5	65	160	60	160	179	12	100	5	3,9
50	70	15	72,7	65	172,5	65	170	192	12	105	5	4,5
55	70	15	73,6	66	189	72	180	210	12	120	5	5,9
60	78	15	78,7	71	202,5	77,5	190	225	12	130	5	6,7
65	78	25	80,3	72	-	95	152	190	16	150	6	9,3
70	82	25	81,3	72	-	98	152	196	16	150	6	11
75	82	25	81,3	72	-	105	170	210	16	170	6	12
80	82,5	25	83	72	-	105	170	210	16	170	7	13
90	92	30	93,5	86	-	125	198	250	20	200	6	18
100	98	30	98,9	86	-	135	219	270	20	220	6	23