

+ BALL BEARING UNITS



---

---

# TECHNICAL DATA INDEX

	Page
<b>1. Construction</b> .....	A3
<b>2. Design Features and Advantages</b> .....	A4
2.1 Maintenance free type .....	A4
2.2 Relubricatable type .....	A4
2.3 Special sealing feature .....	A4
2.4 Secure fitting .....	A5
2.5 Self-aligning .....	A5
2.6 Higher rated load capacity .....	A5
2.7 Light weight yet strong housing .....	A5
2.8 Easy mounting .....	A5
2.9 Accurate fitting of the housing .....	A5
2.10 Bearing replaceability .....	A5
<b>3. Tolerance</b> .....	A6
3.1 Tolerances of ball bearings for the unit .....	A6
3.2 Tolerances of housings .....	A9
<b>4. Basic Load Rating and Life</b> .....	A13
4.1 Bearing life .....	A13
4.2 Basic rated life and basic dynamic load rating .....	A13
4.3 Basic static load rating .....	A15
4.4 Allowable static equivalent load .....	A15
<b>5. Bearing Internal Clearance</b> .....	A16
5.1 Bearing internal clearance .....	A16
5.2 Internal clearance selection .....	A16
5.3 Bearing internal clearance selection standards .....	A17
<b>6. Lubrication</b> .....	A19
6.1 Maximum permissible speed of rotation .....	A19
6.2 Replenishment of grease .....	A19
6.3 Grease fitting .....	A21
6.4 Standard location of the grease fitting .....	A22
<b>7. Recommended Torques for Tightening Set Screws</b> .....	A23

## 1. Construction

The **NSK** bearing unit is a combination of a radial ball bearing, seal, and a housing of high-grade cast iron or pressed steel, which comes in various shapes.

The outer surface of the bearing and the internal surface of the housing are spherical, so that the unit is self-aligning.

The inside construction of the ball bearing for the unit is such that steel balls and retainers of the same type as in series 62 and 63 of the deep groove ball bearing are used. A duplex seal consisting of a combination of an oil-proof synthetic rubber seal and a slinger is

provided on both sides.

Depending on the type, the following methods of fitting to the shaft are employed:

- (1) The inner ring is fastened onto the shaft in two places by set screws.
- (2) The inner ring has a tapered bore and is fitted to the shaft by means of an adapter.
- (3) In the eccentric locking collar system the inner ring is fastened to the shaft by means of eccentric grooves provided at the side of the inner ring and on the collar.

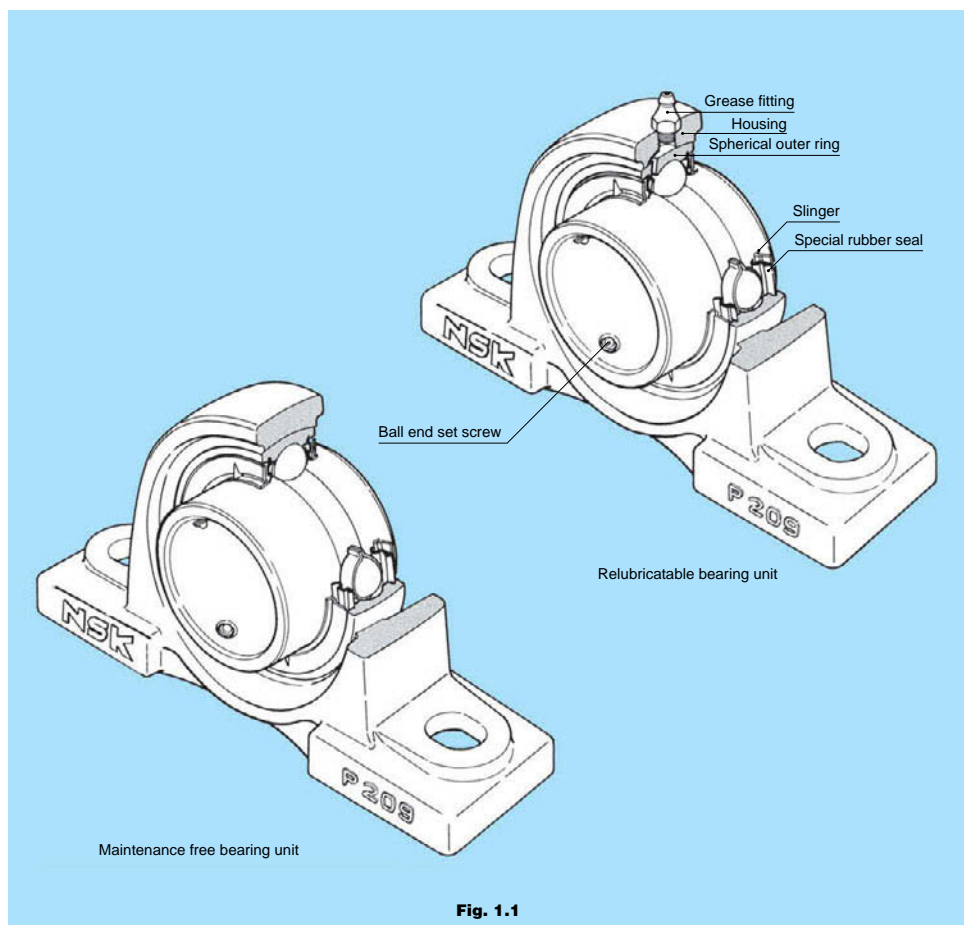

**Fig. 1.1**

## 2. Design Features and Advantages

### 2.1 Maintenance free type

The **NSK** Maintenance free bearing unit contains a high-grade lithium-based grease, good for use over a long period, which is ideally suited to sealed-type bearings. Also provided is an excellent sealing device, which prevents any leakage of grease or penetration of dust and water from outside.

It is designed so that the rotation of the shaft causes the sealed-in grease to circulate through the inside space, effectively providing maximum lubrication. The lubrication effect is maintained over a long period with no need for replenishment of grease.

To summarize the advantages of the **NSK** maintenance free bearing unit:

- (1) As an adequate amount of good quality grease is sealed in at the time of manufacture, there is no need for replenishment. This means savings in terms of time and maintenance costs.
- (2) Since there is no need for any regreasing facilities, such as piping, a more compact design is possible.
- (3) The sealed-in design eliminates the possibility of grease leakage, which could lead to stained products.

### 2.2 Relubricatable type

The **NSK** relubricatable type bearing unit has an advantage over other similar units being so designed as to permit regreasing even in the case of misalignment of 2° to the right or left. The hole through which the grease fitting is mounted usually causes structural weakening of the housing.

However, as a result of extensive testing, in the **NSK** bearing unit the hole is positioned so as to minimize this adverse effect. In addition, the regreasing groove has been designed to minimize weakening of the housing.

While the **NSK** maintenance free type bearing unit is satisfactory for use under normal operating conditions in-doors, in the following circumstances it is necessary to use the relubricatable type bearing unit:

- (1) Cases where the temperature of the bearing rises above 100°C, 212°F:  
\*-Normal temperature of up to 130°C, 266°F heat-resistant bearing units.
- (2) Cases where there is excessive dust, but space does not permit using a bearing unit with a cover.
- (3) Cases where the bearing unit is constantly exposed to splashes of water or any other liquid, but space does not permit using a bearing unit with a cover.
- (4) Cases in which the humidity is very high, and the machine in which the bearing unit is used is run

only intermittently.

- (5) Cases involving a heavy load of which the  $C/P_r$  value is about 10 or below, and the speed is 10  $\text{min}^{-1}$  or below, or the movement is oscillatory.
- (6) Cases where the number of revolutions is relatively high and the noise problem has to be considered; for example, when the bearing is used with the fan of an air conditioner.

### 2.3 Special sealing feature

#### 2.3.1 Standard bearing units

The sealing device of the ball bearing for the **NSK** bearing unit is a combination of a heat-resistant and oil-proof synthetic rubber seal and a slinger of an exclusive design.

The seal, which is fixed in the outer ring, is steel-reinforced, and its lip, in contact with the inner ring, is designed to minimize frictional torque.

The slinger is fixed to the inner ring of the bearing with which it rotates. There is a small clearance between its periphery and the outer ring.

These two types of seals on both sides of the bearing prevent grease leakage, and foreign matter is prevented from entering the bearing from outside.

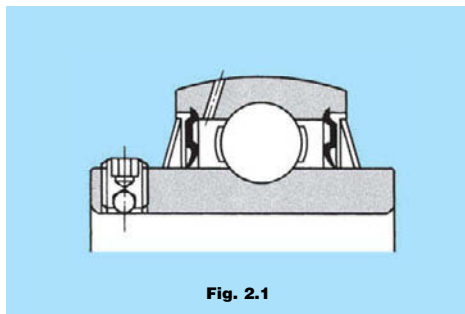

Fig. 2.1

### 2.3.2 Bearing units with covers

The **NSK** bearing unit with a cover consists of a standard bearing unit and an outside covering for extra protection against dust. Special consideration has been given to its design with respect to dust-proofing.

Sealing devices are provided in both the bearing and the housing, so that units of this type operate satisfactorily even in such adverse environments as flour mills, steel mills, foundries, galvanizing plants and chemical plants, where excessive dust is produced and/or liquids are used. They are also eminently suitable for outdoor environments where dust and rain are inevitable, and in heavy industrial machinery such as construction and transportation equipment.

The rubber seal of the cover contacts with the shaft by its two lips, as shown in Fig. 2.2 and 2.3. By filling the groove between the two lips with grease, an excellent sealing effect is obtained and, at the same time, the contacting portions of the lips are lubricated. Furthermore, the groove is so designed that when the shaft is inclined the rubber seal can move in the radial direction.

When bearing units are exposed to splashes of water rather than to dust, a drain hole (5 to 8 mm, 0.2 to 0.3 inches in diameter) is provided at the bottom of the cover, and grease should be applied to the side of the bearing itself instead of into the cover.

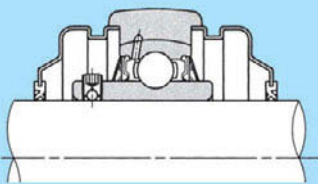

**Fig. 2.2 Pressed steel cover**

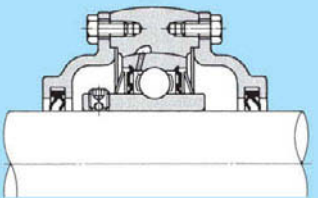

**Fig. 2.3 Cast iron cover**

### 2.4 Secure fitting

Fastening the bearing to the shaft is effected by tightening the ball-end set screw, situated on the inner ring. This is a unique feature which prevents loosening, even if the bearing is subjected to intense vibrations and shocks.

### 2.5 Self-aligning

With the **NSK** bearing unit, the outer surface of the ball bearing and the inner surface of the housing are spherical, thus this bearing unit has self-aligning characteristic. Any misalignment of axis that may arise from poor workmanship on the shaft or errors in fitting will be properly adjusted.

### 2.6 Higher rated load capacity

The bearing used in the unit is of the same internal construction as those in bearing series 62 and 63, and is capable of accommodating axial load as well as radial load, or composite load. The rated load capacity of this bearing is considerably higher than that of the corresponding self-aligning ball bearings used for standard plummer blocks.

### 2.7 Light weight yet strong housing

Housings for **NSK** bearing units come in various shapes. They consist of either high-grade cast iron, one-piece casting, or of precision finished pressed steel, the latter being lighter in weight. In either case, they are practically designed to combine lightness with maximum strength.

### 2.8 Easy mounting

The **NSK** bearing unit is an integrated unit consisting of a bearing and a housing.

As the bearing is prelubricated at manufacture with the correct amount of high-grade lithium base, it can be mounted on the shaft just as it is. It is sufficient to carry out a short test run after mounting.

### 2.9 Accurate fitting of the housing

In order to simplify the fitting of the pillow block and flange type bearing units, the housings are provided with a seat for a dowel pin, which may be utilized as needed.

### 2.10 Bearing replaceability

The bearing used in the **NSK** bearing unit is replaceable. In the event of bearing failure, a new bearing can be fitted to the existing housing.

## 3. Tolerance

The tolerances of the **NSK** bearing units are in accordance with the following JIS specifications:

### 3.1 Tolerances of ball bearings for the unit

The tolerances of ball bearings used in the unit are shown in the following tables, 3.1 to 3.4.

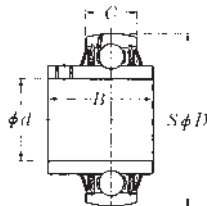

Set screw type

**Table 3.1 (1) Cylindrical bore (UC, UCS, AS, ASS, UEL, UELS, AEL, AELS)**

Unit:  $\mu\text{m}/0.0001$  inch

Nominal bore diameter $d$				Cylindrical bore						Radial runout $K_{ra}$ (reference)
				Bore diameter			Width			
over		incl.		$\Delta d_{mp}$ Deviations		$V_{dp}$ Variations	$\Delta B_{is}, \Delta C_s$ Deviations(reference)		max.	
mm	inch	mm	inch	high	low	max.	high	low		
10	0.3937	18	0.7087	+15 + 6	0 0	10 4	0 0	-120 - 47		15 6
18	0.7087	31.75	1.2500	+18 + 7	0 0	12 5	0 0	-120 - 47	18 7	
31.75	1.2500	50.8	2.0000	+21 + 8	0 0	14 6	0 0	-120 - 47	20 8	
50.8	2.0000	80	3.1496	+24 + 9	0 0	16 6	0 0	-150 - 59	25 10	
80	3.1496	120	4.7244	+28 +11	0 0	19 7	0 0	-200 - 79	30 12	
120	4.7244	180	7.0866	+33 +13	0 0	22 9	0 0	-250 - 98	35 14	

**Remarks** Symbols

$\Delta d_{mp}$ : Mean bore diameter deviation  $V_{dp}$ : Bore diameter variation  $\Delta B$ : Inner ring width deviation  $\Delta C$ : Outer ring width deviation

**Table 3.1 (2) Cylindrical bore (AR, JEL, JELS, REL)**

Unit:  $\mu\text{m}/0.0001$  inch

Nominal bore diameter $d$				Cylindrical bore diameter		
				$\Delta d_{mp}$ Deviations		$V_{dp}$ Variations
over		incl.		high	low	max.
mm	inch	mm	inch			
10	0.3937	18	0.7087	+13 + 5	0 0	6 2
18	0.7087	31.75	1.2500	+13 + 5	0 0	6 2
31.75	1.2500	50.8	2.0000	+13 + 5	0 0	6 2
50.8	2.0000	80	3.1496	+15 + 6	0 0	8 3

**Table 3.1 (3) Cylindrical bore (CS)**

Unit:  $\mu\text{m}/0.0001$  inch

Nominal bore diameter $d$				Cylindrical bore						Radial runout $K_{ia}$ (reference)
over		incl.		Bore diameter			Width			
mm	inch	mm	inch	$\Delta_{dmp}$ Deviations		$V_{dp}$ Variations	$\Delta_{BS}, \Delta_{CS}$ Deviations(reference)			
high	low	high	low	high	low	max.	high	low	max.	
10	0.3937	18	0.7087	0	- 8	10	0	-120	15	
				0	- 3	4	0	- 47	6	
18	0.7087	31.75	1.2500	0	-10	12	0	-120	18	
				0	- 4	5	0	- 47	7	
31.75	1.2500	50.8	2.0000	0	-12	14	0	-120	20	
				0	- 5	6	0	- 47	8	

**Table 3.2 Tapered bore (UK,UKS)** Unit:  $\mu\text{m}/0.0001$  inch

Nominal bore diameter $d$				$\Delta_{dmp}$ Deviations		$\Delta_{dimp} - \Delta_{dmp}$		$V_{dp}^{(1)}$
over		incl.		high	low	max.	min.	
mm	inch	mm	inch	high	low	max.	min.	max.
18	0.7087	30	1.1811	+21	0	+21	0	13
				+ 8	0	+ 8	0	5
30	1.1811	50	1.9685	+25	0	+25	0	15
				+10	0	+10	0	6
50	1.9685	80	3.1496	+30	0	+30	0	19
				+12	0	+12	0	7
80	3.1496	120	4.7244	+35	0	+35	0	25
				+14	0	+14	0	10
120	4.7244	180	7.0866	+40	0	+40	0	31
				+16	0	+16	0	12

Note (1) To be applied for all radial flat surfaces of tapered hole.

Remarks 1. To be applied for tapered holes of 1/12.

2. Symbols of quantity or values

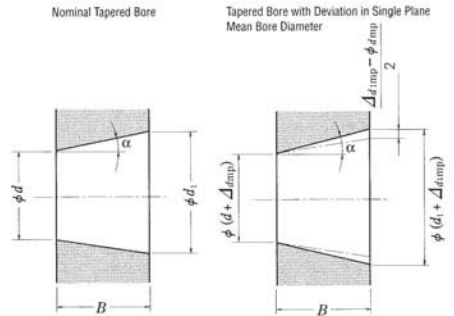

$d$  : Nominal Bore Diameter

$d_1$  : Theoretical Diameter of Larger End of Tapered Bore

$$d_1 = d + 1/12 B$$

$\Delta_{dmp}$  : Single Plane Mean Bore Diameter Deviation in Theoretical Diameter of Smaller End of Bore

$\Delta_{dimp}$  : Single Plane Mean Bore Diameter Deviation in Theoretical Diameter of Larger End of Bore

$V_{dp}$  : Bore diameter variation in a single radial plane

$B$  : Nominal Inner Ring width

$\alpha$  : Half of Taper Angle of Tapered Bore

$$\alpha = 2^\circ 23' 9.4''$$

$$= 2.38594^\circ$$

$$= 0.041643 \text{ rad}$$

# Technical Data

**Table 3.3 Outer ring**

Unit:  $\mu\text{m}/0.0001 \text{ inch}$

Nominal outside diameter $D$				Mean outside diameter deviation $\Delta_{Dm}$		Radial runout $K_{ra}$ (reference)
over		incl.		high	low	max.
mm	inch	mm	inch			
18	0.7087	30	1.1811	0	-9	15
				0	-4	6
30	1.1811	50	1.9685	0	-11	20
				0	-4	8
50	1.9685	80	3.1496	0	-13	25
				0	-5	10
80	3.1496	120	4.7244	0	-15	35
				0	-6	14
120	4.7244	150	5.9055	0	-18	40
				0	-7	16
150	5.9055	180	7.0866	0	-25	45
				0	-10	18
180	7.0866	250	9.8425	0	-30	50
				0	-12	20
250	9.8425	315	12.4016	0	-35	60
				0	-14	24

**Remarks** The low deviation of outside diameter  $D_m$  does not apply within the distance of 1/4 the width of the outer ring from the side.

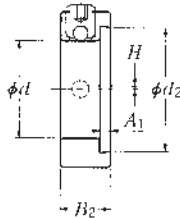

Eccentric locking collar

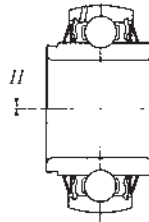

Eccentric locking collar type

**Table 3.4 Eccentric locking collar**

Unit:  $\text{mm}/\text{inch}$

Nominal bore diameter $d$				Bore diameter deviation $\Delta_{ds}$		Small bore diameter of eccentric surface deviation $\Delta_{d2s}$		Eccentricity deviation $\Delta_{Hs}$		Collar width deviation $\Delta_{B2s}$		Collar eccentric surface width deviation $\Delta_{A1s}$	
over		incl.		high	low	high	low	high	low	high	low	high	low
mm	inch	mm	inch										
10	0.3937	36.512	1.4375	+0.250	+0.025	+0.3	0	+0.1	-0.1	+0.270	-0.270	0	-0.180
				+0.010	+0.001	+0.012	0	+0.004	-0.004	+0.011	-0.011	0	-0.007
36.512	1.4375	55.562	2.1875	+0.300	+0.025	+0.4	0	+0.1	-0.1	+0.330	-0.330	0	-0.180
				+0.012	+0.001	+0.016	0	+0.004	-0.004	+0.013	-0.013	0	-0.007
55.562	2.1875	61.912	2.4375	+0.300	+0.025	+0.4	0	+0.1	-0.1	+0.330	-0.330	0	-0.220
				+0.012	+0.001	+0.016	0	+0.004	-0.004	+0.013	-0.013	0	-0.009



### 3.2 Tolerances of housings

**Table 3.5 Spherical bore diameter of housings**

Unit:  $\mu\text{m}/0.0001 \text{ inch}$

Nominal spherical bore diameter $D_s$				$D_s$ Deviations $\Delta_{Damp}$					
over		incl.		Tolerance class H7		Tolerance class J7		Tolerance class K7	
mm	inch	mm	inch	high	low	high	low	high	low
30	1.1811	50	1.9685	+25 +10	0 0	+14 + 6	-11 - 4	+ 7 + 3	-18 - 7
50	1.9685	80	3.1496	+30 +12	0 0	+18 + 7	-12 - 5	+ 9 + 4	-21 - 8
80	3.1496	120	4.7244	+35 +14	0 0	+22 + 9	-13 - 5	+10 + 4	-25 -10
120	4.7244	180	7.0866	+40 +16	0 0	+26 +10	-14 - 6	+12 + 5	-28 -11
180	7.0866	250	9.8425	+46 +18	0 0	+30 +12	-16 - 6	+13 + 5	-33 -13
250	9.8425	315	12.4016	+52 +20	0 0	+36 +14	-16 - 6	+16 + 6	-36 -14

**Remarks** 1. Symbols

$\Delta_{Damp}$ : Mean spherical bore diameter deviation

2. Dimensional tolerances for spherical bore diameter of housing are classified as H7 for clearance fit, and J7 for intermediate fit.

3. Spherical bore diameter of housings are finished by following tolerance classes such as 52mm or less : K7, over 52mm and 180mm or less : J7, and over 180mm : H7 respectively.

**Table 3.6 Pillow block housings (P, PL, HP, UP)**

Unit:  $\text{mm}/\text{inch}$

Housing numbers						$H$ Deviations $\Delta_{Hs}$
P203	—	—	—	—	—	$\pm 0.15$ $\pm 0.006$
P204	—	—	HP204	UP204	PL204	
P205	P305	PX05	HP205	UP205	PL205	
P206	P306	PX06	HP206	UP206	PL206	
P207	P307	PX07	HP207	UP207	PL207	
P208	P308	PX08	HP208	UP208	—	
P209	P309	PX09	HP209	UP209	PL209	
P210	P310	PX10	HP210	UP210	PL210	
P211	P311	PX11	—	—	—	
P212	P312	PX12	—	—	—	
P213	P313	PX13	—	—	—	$\pm 0.2$ $\pm 0.008$
P214	P314	PX14	—	—	—	
P215	P315	PX15	—	—	—	
P216	P316	PX16	—	—	—	
P217	P317	PX17	—	—	—	
P218	P318	PX18	—	—	—	
—	P319	—	—	—	—	
—	P320	PX20	—	—	—	
—	P321	—	—	—	—	
—	P322	—	—	—	—	
—	P324	—	—	—	—	$\pm 0.3$ $\pm 0.012$
—	P326	—	—	—	—	
—	P328	—	—	—	—	

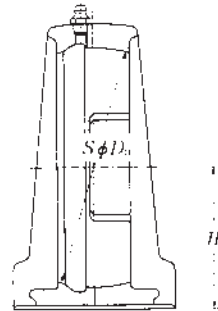

**Remarks** 1.  $H$  is height of the shaft center line.

2. This table can be applied for bearing units with dust covers.

# Technical Data

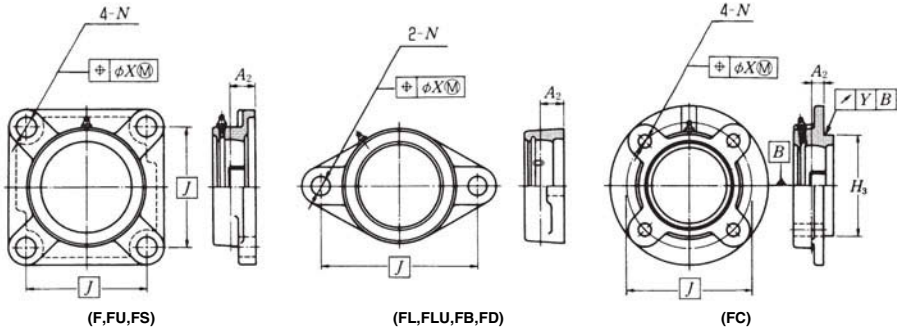

**Table 3.7 (1) Flange unit housings (F,FU,FC,FS,FL,FLU,FB,FD)**

Unit: mm/inch

Housing numbers								location tolerance of bolt hole X	A <sub>2</sub> Deviations ΔA <sub>2s</sub>	H <sub>3</sub> Deviations ΔH <sub>3s</sub>						Radial runout of spigot joint Y
										FC2		FS3		FCX		
										high	low	high	low	high	low	
—	—	—	—	—	—	—	—	0.7 0.028	±0.5 ±0.020	—	—	—	—	—	—	0.2 0.008
F204	—	—	FC204	—	FL204	—	FD204			0	-0.046	—	—	—	—	
F205	F305	FX05	FC205	FS305	FL205	FL305	FD205			0	-0.0018	0	-0.046	0	-0.046	
F206	F306	FX06	FC206	FS306	FL206	FL306	FD206			0	—	0	-0.054	0	-0.054	
F207	F307	FX07	FC207	FS307	FL207	FL307	FD207			0	-0.054	0	-0.0021	0	-0.0021	
F208	F308	FX08	FC208	FS308	FL208	FL308	—			0	-0.0021	—	—	—	—	
F209	F309	FX09	FC209	FS309	FL209	FL309	—			—	—	—	—	—	—	
F210	F310	FX10	FC210	FS310	FL210	FL310	—			—	—	—	—	—	—	
F211	F311	FX11	FC211	FS311	FL211	FL311	—			—	—	—	—	—	—	
F212	F312	FX12	FC212	FS312	FL212	FL312	—			—	—	—	—	—	—	
F213	F313	FX13	FC213	FS313	FL213	FL313	—	1 0.039	±0.8 ±0.032	0	-0.063	—	—	0	-0.063	0.3 0.012
F214	F314	FX14	FC214	FS314	FL214	FL314	—			0	-0.0025	—	—	0	-0.0025	
F215	F315	FX15	FC215	FS315	FL215	FL315	—			—	—	—	—	—	—	
F216	F316	FX16	FC216	FS316	FL216	FL316	—			—	—	—	—	—	—	
F217	F317	FX17	FC217	FS317	FL217	FL317	—			0	-0.072	0	-0.072	0	-0.072	
F218	F318	FX18	FC218	FS318	FL218	FL318	—			0	-0.0028	0	-0.0028	0	-0.0028	
—	F319	—	—	FS319	—	FL319	—			—	—	—	—	—	—	
—	F320	FX20	—	FS320	—	FL320	—			—	—	—	—	—	—	
—	F321	—	—	FS321	—	FL321	—			—	—	0	-0.081	—	—	
—	F322	—	—	FS322	—	FL322	—			—	—	0	-0.0032	—	—	
—	F324	—	—	FS324	—	FL324	—	—	—	—	—	—	—			
—	F326	—	—	FS326	—	FL326	—	—	—	0	-0.089	—	—			
—	F328	—	—	FS328	—	FL328	—	—	—	0	-0.0035	—	—			

- Remarks**
1. J is the bolt hole's center line dimension, and P.C.D. A<sub>2</sub> is distance between the center line of spherical bore diameter of the housing and mounting surfaces, and H<sub>3</sub> is outside diameter of the spigot joint.
  2. Radial runout of spigot joint is applied for flange units with spigot joints.
  3. For FU2 and FLU2 types, tolerances for F2 shall be applied.
  4. For FCX and FLX types, tolerances for FX shall be applied.
  5. This table can be applied for bearing units with dust covers.

**Table 3.7 (2) Flange unit housings (diameter of bolt hole)**

Housing type	Nominal bore diameter N				N Deviations ΔN <sub>s</sub>	
	over		incl.		mm	inch
	mm	inch	mm	inch		
F, FU, FC, FS FA, FH, FLU	—	—	30	1.1811	±0.2	±0.008
	30	1.1811	41	1.6142	±0.3	±0.012

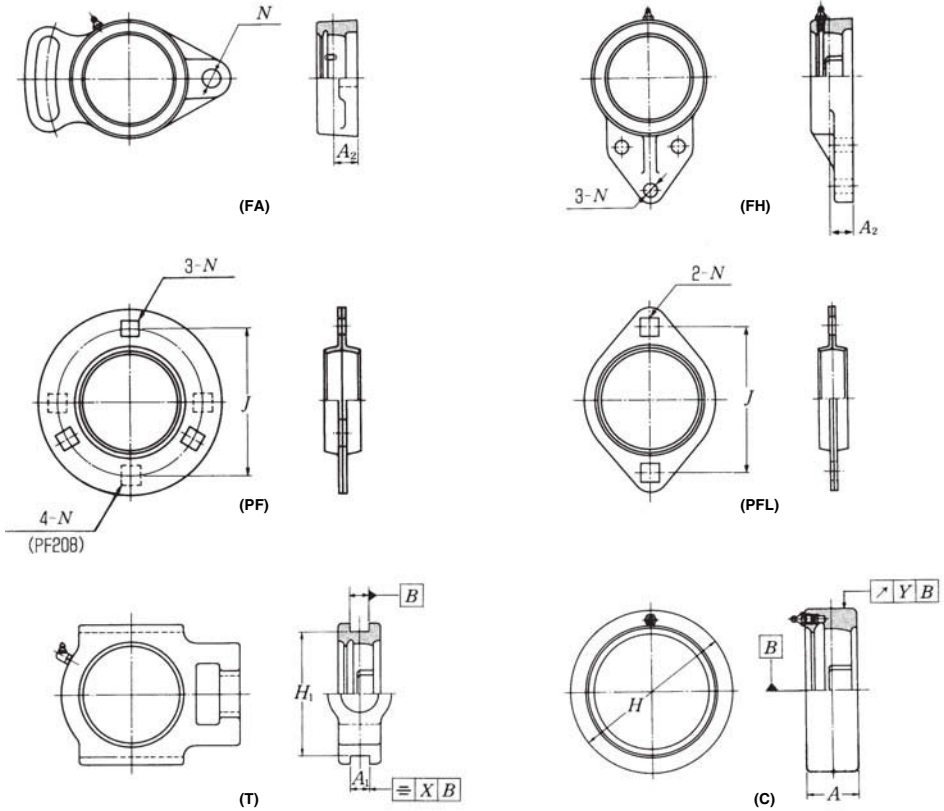

**Table 3.8 Flange unit housings (FH,FA,PF,PFL)**

Unit: mm/inch

Housing numbers	$A_2$ Deviations $\Delta_{A2s}$	Housing numbers	$J$ Deviations $\Delta_{Js}$	$N$ Deviations $\Delta_{Ns}$
—		PF203		
FH,FA204		PF204		
FH,FA205		PF205		
FH,FA206	$\pm 0.5$	PF206		
FH,FA207	$\pm 0.020$	PF207	$\pm 0.4$	$\pm 0.25$
FH,FA208		PF208	$\pm 0.016$	$\pm 0.010$
FH,FA209		PFL203		
FH,FA210		PFL204		
		PFL205		
		PFL206		
FA211	$\pm 0.8$	PFL207		
	$\pm 0.032$			

**Remarks** 1.  $A_2$  is distance between the center line of spherical bore diameter of housings.

2.  $J$  is the bolt hole's center line dimension.

# Technical Data

**Table 3.9 Take-up unit housings (T)**

Unit: mm/inch

Housing numbers	$A_1$ Deviations $\Delta A_{1s}$		$H_1$ Deviations $\Delta H_{1s}$		Parallelism of guide $X$
			high	low	
T204	—	—			
T205	T305	TX05			
T206	T306	TX06	+0.2 0	-0.5 -0.020	0.5 0.020
T207	T307	TX07	+0.008 0	0	
T208	T308	TX08			
T209	T309	TX09			
T210	T310	TX10			
T211	T311	TX11			
T212	T312	TX12			
T213	T313	TX13			
T214	T314	TX14			0.6 0.024
T215	T315	TX15			
T216	T316	TX16			
T217	T317	TX17	+0.3 0	-0.8 -0.032	
—	T318	—	+0.012 0		
—	T319	—			
—	T320	—			0.7 0.028
—	T321	—			
—	T322	—			
—	T324	—			
—	T326	—			0.8 0.032
—	T328	—			

- Remarks**
1.  $A_1$  is the width of guide rail grooves.
  2.  $H_1$  is the maximum span of guide rail grooves.
  3. This table can be applied for bearing units with dust covers.

**Table 3.10 Cartridge unit housings (C)**

Unit: mm/inch

Housing numbers	$H$ Deviations $\Delta H_s$						Radial runout of outside surface $Y$	$A$ Deviations $\Delta A_s$
	C2 Series		C3 Series		CX Series			
	high	low	high	low	high	low		
C204	—	—						
C205	C305	CX05	0	-0.030	—	—		
C206	C306	CX06	0	-0.0012	—	—		
C207	C307	CX07			0	-0.035	0.2 0.008	±0.2 ±0.008
C208	C308	CX08	0	-0.035	0	-0.0014		
C209	C309	CX09	0	-0.0014				
C210	C310	CX10			0	-0.040		
C211	C311	CX11	0	-0.040	0	-0.0016		
C212	C312	CX12	0	-0.0016				
C213	C313	—					0.3 0.012	
—	C314	—						
—	C315	—						
—	C316	—			0	-0.046		
—	C317	—			0	-0.0018		±0.3 ±0.012
—	C318	—						
—	C319	—						
—	C320	—						
—	C321	—			0	-0.052	0.4 0.016	
—	C322	—			0	-0.0020		
—	C324	—						
—	C326	—			0	-0.057		
—	C328	—			0	-0.0022		

- Remarks**
1.  $H$  is the outside diameter of cartridge housings.
  2.  $A$  is width of cartridge housings.

## 4. Basic Load Rating and Life

### 4.1 Bearing life

Even in bearings operating under normal conditions, the surfaces of the raceway and rolling elements are constantly being subjected to repeated compressive stresses which cause flaking of these surfaces to occur. This flaking is due to material fatigue and will eventually cause the bearings to fail. The effective life of a bearing is usually defined in terms of the total number of revolutions a bearing can undergo before flaking of either the raceway surface or the rolling element surfaces occurs.

Other causes of bearing failure are often attributed to problems such as seizing, abrasions, cracking, chipping, gnawing, rust, etc. However, these so called "causes" of bearing failure are usually themselves caused by improper installation, insufficient or improper lubrication, faulty sealing or inaccurate bearing selection. Since the above mentioned "cause" of bearing failure can be avoided by taking the proper precautions, and are not simply caused by material fatigue, they are considered separately from the flaking aspect.

### 4.2 Basic rated life and basic dynamic load rating

A group of seemingly identical bearings when subjected to identical load and operating conditions will exhibit a wide diversity in their durability.

This "life" disparity can be accounted for by the difference in the fatigue of the bearing material itself. This disparity is considered statistically when calculating bearing life, and the basic rated life is defined as follows.

The basic rated life is based on a 90% statistical model which is expressed as the total number of revolutions 90% of the bearings, in an identical group of bearings subjected to identical operating conditions, will attain or surpass before flaking due to material fatigue occurs. For bearings operating at fixed constant speeds, the basic rated life (90% reliability) is expressed in the total number of hours of operation.

The basic dynamic load rating is an expression of the load capacity of a bearing based on a constant load which the bearing can sustain for one million revolutions (the basic life rating). For radial bearings this rating applies to pure radial loads, and for thrust bearings it refers to pure axial loads. The basic dynamic load ratings given in the bearing tables of this catalog are for bearings constructed of standard bearing materials, using standard manufacturing techniques. Please consult **NSK** for basic load ratings of bearings constructed of special materials or using special

manufacturing techniques.

The relationship between the basic rated life, the basic dynamic load rating and the bearing load is given in formula (4.1).

$$L_{10} = \left( \frac{C_r}{P_r} \right)^3 \dots\dots\dots (4.1)$$

where,

$L_{10}$  : Basic rated life  $10^6$  revolutions

$C_r$  : Basic dynamic rated load, N, lbf

$P_r$  : Equivalent dynamic load, N, lbf

The basic rated life can also be expressed in terms of hours of operation (revolution), and is calculated as shown in formula (4.2).

$$L_{10h} = 500 f_h^3 \dots\dots\dots (4.2)$$

$$f_h = f_n \frac{C_r}{P_r} \dots\dots\dots (4.3)$$

$$f_n = \left( \frac{33.3}{n} \right)^{1/3} \dots\dots\dots (4.4)$$

where,

$L_{10h}$  : Basic rated life, h

$f_h$  : Life factor

$f_n$  : Speed factor

$n$  : Rotational speed,  $\text{min}^{-1}$

Formula (4.2) can also be expressed as shown in formula (4.5).

$$L_{10h} = \frac{10^6}{60n} \left( \frac{C_r}{P_r} \right)^3 \dots\dots\dots (4.5)$$

The relation between rotational speed  $n$  and speed factor  $f_n$  as well as the relation between the basic rated life  $L_{10h}$  and the life factor  $f_h$  is shown in Fig. 4.1.

When several bearings are incorporated in machines or equipment as complete units, all the bearings in the unit are considered as a whole when computing bearing life (see formula 4.6). The total bearing life of the unit is a life rating based on the viable lifetime of the unit before even one of the bearings fails due to rolling contact fatigue.

# Technical Data

$$L = \frac{1}{\left(\frac{1}{L_1^{1.1}} + \frac{1}{L_2^{1.1}} + \dots + \frac{1}{L_n^{1.1}}\right)^{1/1.1}} \dots\dots\dots(4.6)$$

where,

$L$  :Total life of the whole bearing assembly,h

$L_1, L_2, \dots, L_n$ : Rated life of bearings 1, 2,...  $n$ , h

In the case where load and the number of revolutions change at regulated intervals, after finding the rated life

$L_1, L_2, \dots, L_n$  under conditions of  $n_1, P_1; n_2, P_2; \dots$

$n_n, P_n$ : the built-in life  $L_m$  can be given by the formula (4.7).

$$L_1 = \frac{10^6}{60n_1} \left(\frac{C_r}{P_1}\right)^3$$

$$L_2 = \frac{10^6}{60n_2} \left(\frac{C_r}{P_1}\right)^3$$

$$\vdots$$

$$L_n = \frac{10^6}{60n_n} \left(\frac{C_r}{P_n}\right)^3$$

$$L_m = \left(\frac{\phi_1}{L_1} + \frac{\phi_2}{L_2} + \dots + \frac{\phi_n}{L_n}\right)^{-1} \dots\dots\dots(4.7)$$

where,

$L_1, L_2, \dots, L_n$ : Rated life under condition 1, 2,...  $n$ , h

$n_1, n_2, \dots, n_n$ : Number of revolutions under condition 1, 2, ...  $n$ ,  $\text{min}^{-1}$

$P_1, P_2, \dots, P_n$ : Equivalent load under condition 1, 2, ...  $n$ , N, lbf

$\phi_1, \phi_2, \dots, \phi_n$ : Ratio of condition 1, 2, ...  $n$  accounting for the total operating time

$L_m$ : Built-in life, h

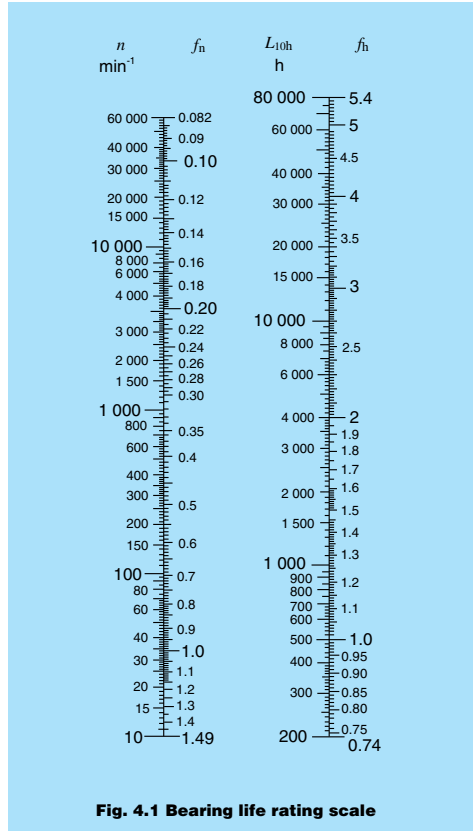

**Fig. 4.1 Bearing life rating scale**

**Table 4.1 Rating life for applications**

Service classification	Machine application	Life time $L_n$
Machines used occasionally	Door mechanisms, Garage shutter	500
Equipment for short period or intermittent service-interruption permissible	Household appliances, Electric hand tools, Agricultural machines, Lifting tackles in shops	4 000 to 8 000
Intermittent service machines-high reliability	Power-Station auxiliary equipment, Elevators, Conveyors, Deck cranes	8 000 to 14 000
Machines used for 8 hours a day, but not always in full operation	Ore wagon axles, important gear units	14 000 to 20 000
Machines fully used for 8 hours	Blowers, General machinery in shops, Continuous operation cranes	20 000 to 30 000
Machines continuously used for 24 hours a day	Compressors, Pumps	50 000 to 60 000
Machines continuously used for 24 hours a day with maximum reliability	Power-station equipment, Water-supply equipment for urban areas, Mine ventilators	100 000 to 200 000

### 4.3 Basic static load rating

When stationary rolling bearings are subjected to static loads, they suffer from partial permanent deformation of the contact surfaces at the contact point between the rolling elements and the raceway. The amount of deformity increases as the load increases, and if this increase in load exceeds certain limits, the subsequent smooth operation of the bearing is impaired.

It has been found through experience that a permanent deformity of 0.0001 times the diameter of the rolling element, occurring at the most heavily stressed contact point between the raceway and the rolling elements, can be tolerated without any impairment in running efficiency.

The basic rated static load refers to a fixed static load limit at which a specified amount of permanent deformation occurs. It applies to pure radial loads for radial bearings. The maximum applied load values for contact stress occurring at the rolling element and raceway contact points are given below.

For ball bearings (for bearing unit): 4 200 MP.

### 4.4 Allowable static equivalent load

Generally the static equivalent load which can be permitted is limited by the basic static rated load as stated in Section 4.3. However, depending on requirements regarding friction and smooth operation, these limits may be greater or lesser than the basic static rated load.

In the following formula (4.8) and Table 4.2 the safety factor  $S_0$  can be determined considering the maximum static equivalent load.

$$S_0 = \frac{C_0}{P_{0 \max}} \dots \dots \dots (4.8)$$

where,

$S_0$  : Safety factor

$C_0$  : Basic static rated load, N, lbf

$P_{0 \max}$  : Maximum static equivalent load, N, lbf

**Table 4.2 Minimum safety factor values  $S_0$**

Operating conditions	Ball bearings
High rotational accuracy demand	2
Normal rotating accuracy demand (Universal application)	1
Slight rotational accuracy deterioration permitted (Low speed, heavy loading, etc.)	0.5

**Remarks** When vibration and/or shock loads are present, a load factor based on the shock load needs to be included in the  $P_{0 \max}$  value.

## 5. Bearing Internal Clearance

### 5.1 Bearing internal clearance

Bearing internal clearance(initial clearance)is the amount of internal clearance a bearing has before being installed on a shaft or in a housing.

As shown in Fig. 5.1, when either the inner ring or the outer ring is fixed and the other ring is free to move, displacement can take place in either an axial or radial direction. This amount of displacement (radially or axially) is termed the internal clearance and, depending on the direction, is called the radial internal clearance or the axial internal clearance.

When the internal clearance of a bearing is measured, a slight measurement load is applied to the raceway so the internal clearance may be measured accurately. However, at this time, a slight amount of elastic deformation of the bearing occurs under the measurement load, and the clearance measurement value (measured clearance) is slightly larger than the true clearance. This discrepancy between the true bearing clearance and the increased amount due to the elastic deformation must be compensated for. These compensation values are given in Table 5.1.

The internal clearance values for each bearing class are shown in Tables 5.3.

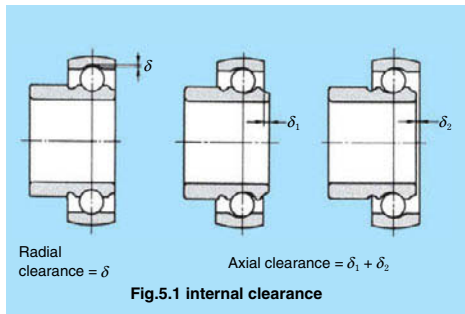

### 5.2 Internal clearance selection

The internal clearance of a bearing under operating conditions (effective clearance) is usually smaller than the same bearing's initial clearance before being installed and operated. This is due to several factors including bearing fit, the difference in temperature between the inner and outer rings, etc. As a bearing's operating clearance has an effect on bearing life, heat generation, vibration, noise, etc.; care must be taken in selecting the most suitable operating clearance.

Effective internal clearance:

The internal clearance differential between the initial clearance and the operating (effective) clearance (the amount of clearance reduction caused by interference fits, or clearance variation due to the temperature difference between the inner and outer rings) can be calculated by the following formula:

$$\delta_{\text{eff}} = \delta_o - (\delta_i + \delta_t) \dots\dots\dots (5.1)$$

where,

$\delta_{\text{eff}}$  : Effective internal clearance, mm

$\delta_o$  : Bearing internal clearance, mm

$\delta_i$  : Reduced amount of clearance due to interference, mm

$\delta_t$  : Reduced amount of clearance due to temperature differential of inner and outer rings, mm

Reduced clearance due to interference:

When bearings are installed with interference fits on shafts and in housings, the inner ring will expand and the outer ring will contract; thus reducing the bearings' internal clearance. The amount of expansion or contraction varies depending on the shape of the bearing, the shape of the shaft or housing, dimensions of the respective parts, and the type of materials used. The differential can range from approximately 70% to 90% of the effective interference.

$$\delta_i = (0.70 \text{ to } 0.90) \Delta d_{\text{eff}} \dots\dots\dots (5.2)$$

where,

$\delta_i$  : Reduced amount of clearance due to interference,mm

$\Delta d_{\text{eff}}$  : Effective interference,mm

Reduced internal clearance due to inner/outer ring temperature difference:

During operation, normally the outer ring will be from 5° to 10°C cooler than the inner ring or rotating parts. However,if the cooling effect of the housing is large,

**Table 5.1 Adjustment of radial internal clearance based on measured load** Unit  $\mu\text{m}$

Nominal Bore Diameter $d$ (mm)	Measuring Load (N)	Radial Clearance Increase				
		C2	CN	C3	C4	C5
over 10 incl. 18	24.5	3 to 4	4	4	4	4
18 50	49	4 to 5	5	6	6	6
50 200	147	6 to 8	8	9	9	9



the shaft is connected to a heat source, or a heated substance is conducted through the hollow shaft; the temperature difference between the two rings can be ever greater. The amount of internal clearance is thus further reduced by the differential expansion of the two rings.

$$\delta_i = \alpha \Delta_T D_o \dots\dots\dots (5.3)$$

where,

$\delta_i$  : Amount of reduced clearance due to heat differential, mm

$\alpha$  : Bearing steel linear expansion coefficient  $12.5 \times 10^{-6}/^{\circ}\text{C}$

$\Delta_T$  : Inner/outer ring temperature differential,  $^{\circ}\text{C}$

$D_o$  : Outer ring raceway diameter, mm

Outer ring raceway diameter,  $D_o$ , values can be approximated by using formula 5.4.

For ball bearings,

$$D_o = 0.20(d+4.0D) \dots\dots\dots (5.4)$$

where,

$d$  : Bearing bore diameter, mm

$D$  : Bearing outside diameter, mm

### 5.3 Bearing internal clearance selection standards

Theoretically, in regard to bearing life, the optimum operating internal clearance for any bearing would be a slight negative clearance after the bearing had reached normal operating temperature.

Unfortunately, under actual operating conditions, maintaining such optimum tolerances is often difficult at best. Due to various fluctuating operating conditions this slight minus clearance can quickly become a large minus, greatly lowering the life of the bearing and causing excessive heat to be generated. Therefore, an initial internal clearance which will result in a slightly greater than negative internal operating clearance should be selected.

Under normal operating conditions (e.g. normal load, fit, speed, temperature, etc.), a standard internal clearance will give a very satisfactory operating clearance.

Table 5.2 lists non-standard clearance recommendations for various applications and operating conditions.

**Table 5.2 Examples of applications where bearing clearances other than normal clearance are used**

Operating conditions	Applications	Selected clearance
Shaft is heated and housing is cooled.	Conveyor of casting machine	C5
Shaft or inner ring is heated.	Annealing pit, Drying pit, Curing pit	C4
Allows for shaft deflection and fitting errors.	Disc harrows	C4
	Combines	C3
Tight-fitted for both inner and outer rings.	Large blowers	C3
To reduce noise and vibration when rotating.	Multi-wing fan of air conditioners	C2

# Technical Data

**Table 5.3(1)Cylindrical bore bearings**

Unit:  $\mu\text{m}/0.0001 \text{ inch}$

Nominal bore diameter <i>d</i>				Radial internal clearance															
				C2		CN		C3		C4									
over mm	incl. inch	mm	inch	min.	max.	min.	max.	min.	max.	min.	max.								
10	0.3937	18	0.7087	0	0	9	4	3	1	18	7	11	4	25	10	18	7	33	13
18	0.7087	24	0.9449	0	0	10	4	5	2	20	8	13	5	28	11	20	8	36	14
24	0.9449	30	1.1811	1	0	11	4	5	2	20	8	13	5	28	11	23	9	41	16
30	1.1811	40	1.5748	1	0	11	4	6	2	20	8	15	6	33	13	28	11	46	18
40	1.5748	50	1.9685	1	0	11	4	6	2	23	9	18	7	36	14	30	12	51	20
50	1.9685	65	2.5591	1	0	15	6	8	3	28	11	23	9	43	17	38	15	61	24
65	2.5591	80	3.1496	1	0	15	6	10	4	30	12	25	10	51	20	46	18	71	28
80	3.1496	100	3.9370	1	0	18	7	12	5	36	14	30	12	58	23	53	21	84	33
100	3.9370	120	4.7244	2	1	20	8	15	6	41	16	36	14	66	26	61	24	97	38
120	4.7244	140	5.5118	2	1	23	9	18	7	48	19	41	16	81	32	71	28	114	45

**Remarks** Heat-resistant bearings with suffix HT2 have C4 clearances.

**Table 5.3(2)Tapered bore bearings**

Unit:  $\mu\text{m}/0.0001 \text{ inch}$

Nominal bore diameter <i>d</i>				Radial internal clearance															
				C2		CN		C3		C4									
over mm	incl. inch	mm	inch	min.	max.	min.	max.	min.	max.	min.	max.								
24	0.9449	30	1.1811	5	2	20	8	13	5	28	11	23	9	41	16	30	12	53	21
30	1.1811	40	1.5748	6	2	20	8	15	6	33	13	28	11	46	18	40	16	64	25
40	1.5748	50	1.9685	6	2	23	9	18	7	36	14	30	12	51	20	45	18	73	29
50	1.9685	65	2.5591	8	3	28	11	23	9	43	17	38	15	61	24	55	22	90	35
65	2.5591	80	3.1496	10	4	30	12	25	10	51	20	46	18	71	28	65	26	105	41
80	3.1496	100	3.9370	12	5	36	14	30	12	58	23	53	21	84	33	75	30	120	47
100	3.9370	120	4.7244	15	6	41	16	36	14	66	26	61	24	97	38	90	35	140	55
120	4.7244	140	5.5118	18	7	48	19	41	16	81	32	71	28	114	45	105	41	160	63

# 6.Lubrication

As bearings in **NSK** bearing units have sufficient high-grade grease sealed in at the time of manufacture, there is no need for replenishment while in use. The amount of grease necessary for lubrication is, in general, very small. With the **NSK** bearing units, the amount of grease occupies about a half to a third of the space inside the bearing.

## 6.1 Maximum permissible speed of rotation

The maximum speed possible while ensuring the safety and long life of ball bearings used in the unit is limited by their size, the circumferential speed at the point where the seal comes into contact, and the load acting on them.

To indicate the maximum speed permissible, it is customary to use the value of  $dn$  or  $d_m n$  ( $d$  is the bore of the bearing;  $d_m$  is the diameter of the pitch circle= $(I. D.+O.D.) / 2$ ;  $n$  is the number of revolutions).

Problem connected with the lubrication of bearings are the generation of heat and seizures occurring at the sliding parts inside the bearing, in particular at the points where the ball is in contact with the retainer, inner and outer rings. The contact pressure at the points where friction occurs on the retainer is only

slightly affected by the load acting on the bearing; the amount of heat generated there is approximately in proportion to the sliding velocity. Therefore, this sliding velocity serves as a yardstick to measure the limit of the rotating speed of the bearing. In the case of a bearing unit, however, there is another large factor that has to be taken into account—the circumferential speed at the part where the seal is in contact.

The graph in Fig.6.1 indicates the maximum speed of rotation permissible, taking into account the aforementioned factors.

There are two common methods of locking the bearing unit onto the shaft—the set screw system and the eccentric collar system. However, in both of these systems high-speed operation will cause deformation of the inner ring, which may result in vibration of the bearing. For high-speed operation, therefore, it is recommended that an interference fit or a clearance fit with a near-zero clearance be used.

For standard bearing units with the contact type seal, the maximum speed permissible is  $120\,000/d$ . Where a higher speed is required, bearing units with the non-contact type seal, are advised. Please contact **NSK** regarding the use of the latter type. Additionally, it is necessary that the surface on which the housing is mounted be finished to as high a degree of accuracy as possible. A regularity of within  $\pm 0.05mm$ ,  $\pm 0.002inch$  is required.

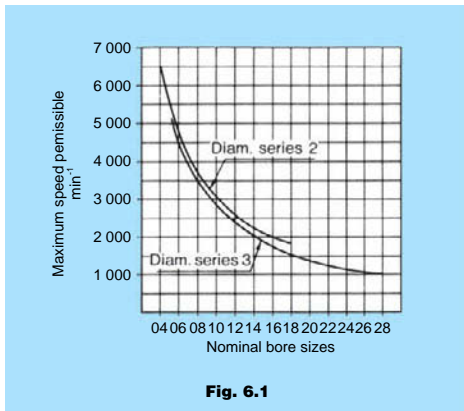

## 6.2 Replenishment of grease

### 6.2.1 Sealed-in grease

With **NSK** bearing units, no relubrication is the general rule. The standard self-lubricating type of bearing units contain high-grade lithium-based grease which, being suitable for long-term use, is ideal for sealed-type bearings. Relubrication, therefore, is unnecessary under most operating conditions.

At high temperatures, or where there is exposure to: water or excessive dust, the highest quality grease is essential. Therefore, **NSK** uses its own specially selected brands which are shown in Table 6.1. It is necessary to use the same brand when replenishing grease.

Table 6.1 Brands of grease used in **NSK** bearing units

Bearing units	Grease			Symbols	Operating temperature range °C, °F
	Name of grease	Thickening agent	Base oil		
Standard	Alvania grease S3	Li soap	Mineral oil	D1	-10°to +100°C, (+14°to +212°F).
Heat-resistant	SH44MT	Li soap	Silicone oil	HT2D1	Nomal temp.to + 130°C(266°F).
Cold-resistant	SH33L	Li soap	Silicone oil	CT1D1	-60°C(-76°F)to nomal temp.

## 6.2.2 Mixing of different kinds of grease

Whether or not different kinds of grease may be mixed usually depends on their thickeners. The commonly used criteria are shown in Table 6.2. Properties which are most susceptible to influences from mixing are viscosity, dropping point and penetration. Water and heat resisting properties as well as mechanical stability are also lowered. Therefore, when mixing in a grease which is different to that which is already in use, it is essential that the thickener (soap base) and the base oil be of the same group.

When relubricating **NSK** bearing units, it is advisable to use the brands of grease shown in Table 6.1

**Table 6.2 Mixing properties of grease**

Soap base	Ca	Na	Al	Ba	Li
Ca				x	
Na				x	x
Al				x	x
Ba	x	x	x		x
Li		x	x	x	

Mixing will not produce any appreciable change of properties.

Mixing may produce considerable variations of properties.

x Mixing will cause a drastic change of properties.

## 6.2.3 Relubrication frequency

Relubrication frequency varies with the kind and quality of grease used as well as the operating conditions. Therefore, it is difficult to establish a general rule, but under ordinary operating conditions, it is desirable that grease be replenished before one third (1/3) of its calculated life elapses. It is necessary, however, to take into consideration such factors as hardening of grease in the oil hole, making replenishment impossible; deterioration of grease while operation of the machine is suspended, and so forth.

In Table 6.3 below are shown standard relubrication frequencies. Irrespective of the calculated life of the grease, this list takes into consideration such factors as the rotational speed of the bearings, operating temperatures and environmental conditions, with a view to safety.

## 6.2.4 Re-greasing

The performance of a bearing is greatly influenced by the quantity of grease. In order to avoid over-filling, it is advisable to replenish the grease while the machine is in operation.

Continue to insert grease until a little oozes out from between the outer ring raceway and the periphery of the slinger, for optimum performance.

**Table 6.3 Standard relubrication frequencies**

Type of unit	Symbol	dn Value	Environmental conditions	Operating temp. °C, °F	Relubrication frequency	
					Hours	Period
Standard	D1	40 000 and below	Ordinary	-10 to +80, +14 to +176	1 500 to 3 000	6 to 12 mo.
Standard	D1	70 000 and below	Ordinary	-10 to +80, +14 to +176	1 000 to 2 000	3 to 6 mo.
Standard	D1	70 000 and below	Ordinary	+80 to +100, +176 to +212	500 to 700	1 mo.
Heat-resistant	HT2D1	70 000 and below	Ordinary	+100 to +130, +212 to +266	300 to 700	1 mo.
Cold-resistant	CT1D1	70 000 and below	Ordinary	-60 to +80, -76 to +176	1 000 to 2 000	3 to 6 mo.
Standard	D1	70 000 and below	Very dusty	-10 to +100, +14 to +212	100 to 500	1 wk. to 1 mo.
Standard	D1	70 000 and below	Exposed to water splashes	-10 to +100, +14 to +212	30 to 100	1 day to 1 wk.

### 6.3 Grease fitting

NSK bearing units are, as a general rule, provided with a grease fitting, as shown in Table 6.4, and a grease gun is used for regreasing. However, button-head and pin types may also be furnished on demand.

Grease fitting dimensions and the designation of applicable bearing units are given in Table 6.5.

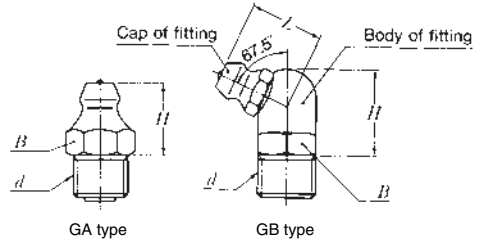

**Table 6.4 Grease fitting types available for bearing units.**

Types of housing	Standard grease fitting types
Pillow type	GA type
Flange type	GA type
Take-up type	GB type
Hanger type	GA type
Cartridge type	GA type

**Table 6.5 Grease fitting dimensions and designations of applicable bearing units**

GA type(Vertical type)

Designation	$d$	$H$		$B$	
		mm	inch	mm	inch
GA- $\frac{1}{4}$ -28 UNF	$\frac{1}{4}$ -28 UNF	8.5	0.335	7	0.276
GA-PF $\frac{1}{8}$	G $\frac{1}{8}$	12	0.472	10	0.394
GA-PF $\frac{1}{4}$	G $\frac{1}{4}$	14	0.551	14	0.551

GB type(67.5°)











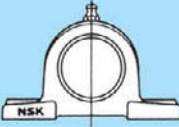

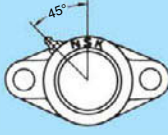
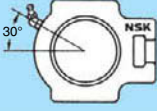
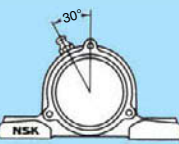

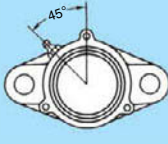
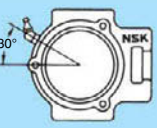
Designation	$d$	$H$		$L$		$B$	
		mm	inch	mm	inch	mm	inch
GB- $\frac{1}{4}$ -28UNF	$\frac{1}{4}$ -28 UNF	10.5	0.413	9.3	0.366	8	0.315
GB-PF $\frac{1}{8}$	G $\frac{1}{8}$	14.2	0.559	13.5	0.531	10	0.394
GB-PF $\frac{1}{4}$	G $\frac{1}{4}$	15	0.591	13.5	0.531	14	0.551

Nominal screw size $d$	Series 2	Series X	Series 3
$\frac{1}{4}$ -28 UNF	203 - 209	X05 - X08	305 - 309
G $\frac{1}{8}$	210 - 215	X09 - X14	310 - 315
G $\frac{1}{4}$	216 - 218	X15 - X20	316 - 328

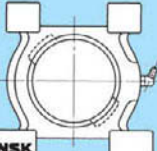
**Remarks** Screw size for the cartridge type is  $\frac{1}{4}$ -28 UNF.  
That for C310D1 to C328D1 is G $\frac{1}{4}$ (PF $\frac{1}{4}$ ).

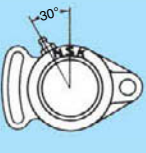
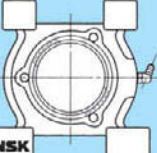
## 6.4 standard location of the grease fitting

Standard location of grease fitting on the housing for the relubricatable bearing units of each type is illustrated below.

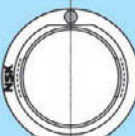
			
P, PL, Z-P, type	C-F type	FL, FLU, Z-FL type	T, Z-T type
			
C-P type	F, FU, Z-F (#204, #205) FS type	C-FL type	C-T type
			
HP type	C-FS type	FH type	M, L, Z-M, Z-L type
			
UP type	FC, Z-FC type	FA type	C-M, C-L type
			
Except (#204, #205) F, FU, Z-F type	C-FC type	HB type	C type

## 7. Recommended Torques for Tightening Set Screws

**Table 7.1 Recommended torques for tightening set screws**

A) Metric series, applied to metric bore size.

Designation of the bearings of applicable units			Designation of set screws	Tightening torques N·m(max.)
UC201 to UC205	—	—	M 5×0.8 × 7	3.9
UC206	—	UC305 to UC306	M 6×0.75 × 8	4.9
UC207	UCX05	—	M 6×0.75 × 8	5.8
UC208 to UC210	—	—	M 8×1 ×10	7.8
UC211	UCX06 to UCX08	UC307	M 8×1 ×10	9.8
UC212	UCX09	—	M10×1.25×12	16.6
UC213 to UC215	—	UC308 to UC309	M10×1.25×12	19.6
UC216	UCX10	—	M10×1.25×12	22.5
—	UCX11 to UCX12	—	M10×1.25×12	24.5
UC217 to UC218	UCX13 to UCX15	UC310 to UC314	M12×1.5 ×13	29.4
—	UCX16 to UCX17	—	M12×1.5 ×13	34.3
—	UCX18	UC315 to UC316	M14×1.5 ×15	34.3
—	UCX20	UC317 to UC319	M16×1.5 ×18	53.9
—	—	UC320 to UC324	M18×1.5 ×20	58.8
—	—	UC326 to UC328	M20×1.5 ×25	78.4

B) Inch series, applied to inch bore size.

Designation of the bearings for the unit to which torques given are applicable			Designation of set screws	Tightening torques lbf·inch(max.)
UC201 to UC205	—	—	No.10-32UNF	34
UC206	—	UC305 to UC306	$\frac{1}{4}$ -28UNF	43
UC207	UCX05	—	$\frac{1}{4}$ -28UNF	52
UC208 to UC210	—	—	$\frac{5}{16}$ -24UNF	69
UC211	UCX06 to UCX08	UC307	$\frac{5}{16}$ -24UNF	86
UC212	UCX09	—	$\frac{3}{8}$ -24UNF	147
UC213 to UC215	—	UC308 to UC309	$\frac{3}{8}$ -24UNF	173
UC216	UCX10	—	$\frac{3}{8}$ -24UNF	199
—	UCX11 to UCX12	—	$\frac{3}{8}$ -24UNF	216
UC217 to UC218	UCX13 to UCX15	UC310 to UC314	$\frac{1}{2}$ -20UNF	260
—	UCX16 to UCX17	—	$\frac{1}{2}$ -20UNF	303
—	UCX18	UC315 to UC316	$\frac{9}{16}$ -18UNF	303
—	UCX20	UC317 to UC319	$\frac{5}{8}$ -18UNF	477
—	—	UC320	$\frac{5}{8}$ -18UNF	520

Designation of the bearings of applicable units	Designation of set screws	Tightening torques N·m(max.)
AS201 to 205	M 5×0.8 × 7	3.4
AS206	M 6×0.75 × 8	4.4
AS207	M 6×0.75 × 8	4.9
AS208	M 8×1 ×10	6.8

Designation of the bearings for the unit to which torques given are applicable	Designation of set screws	Tightening torques lbf·inch(max.)
AS201 to 205	No.10-32UNF	30
AS206	$\frac{1}{4}$ -28UNF	39
AS207	$\frac{1}{4}$ -28UNF	43
AS208	$\frac{5}{16}$ -24UNF	60

# **Contents of ball bearing units and ball bearings for bearing units**



# DIMENSION TABLE

	<i>Pages</i>		<i>Pages</i>
<b>Set screw type</b>		Take-up unit, cast housing	
Pillow block unit, cast housing		<b>UCT2</b> .....	B114
<b>UCP2</b> .....	B4	<b>UCT3</b> .....	B120
<b>UCP3</b> .....	B10	<b>UCTX</b> .....	B126
<b>UCPX</b> .....	B16	Take-up stretcher units	
<b>UCPL2</b> .....	B22	<b>UCT2-</b> .....	B130
<b>UCHP2</b> .....	B26	Take-up type L stretcher units	
<b>UCUP2</b> .....	B30	<b>UCL2-</b> .....	B132
<b>ASPL2</b> .....	B34	Take-up type M stretcher units	
Pillow block unit, pressed steel housing		<b>UCM2-</b> .....	B134
<b>ASPP2</b> .....	B38	<b>UCM3-</b> .....	B136
<b>ASRPP2</b> .....	B40	Take-up mini stretcher units	
Square flanged unit, cast housing		<b>ASPT2-</b> .....	B138
<b>UCF2</b> .....	B42	Cartridge unit, cast housing	
<b>UCF3</b> .....	B48	<b>UCC2</b> .....	B140
<b>UCFX</b> .....	B54	<b>UCC3</b> .....	B142
<b>UCFS3</b> .....	B60	<b>UCCX</b> .....	B146
Round flanged unit, cast housing		<b>Eccentric locking collar type</b>	
<b>UCFC2</b> .....	B66	Pillow block unit, cast housing	
<b>UCFCX</b> .....	B72	<b>UELPL2</b> .....	B148
Rhombus flanged unit, cast housing		<b>UELPL3</b> .....	B152
<b>UCFL2</b> .....	B78	<b>UELPL2</b> .....	B158
<b>UCFL3</b> .....	B84	<b>UELHP2</b> .....	B162
<b>UCFLX</b> .....	B90	<b>UELUP2</b> .....	B164
<b>UCFA2</b> .....	B92	<b>AELPL2</b> .....	B166
<b>UCFH2</b> .....	B96	<b>JELPL2</b> .....	B168
<b>ASFB2</b> .....	B100	Pillow block unit, pressed steel housing	
<b>ASFD2</b> .....	B102	<b>AELPP2</b> .....	B170
Round flanged unit, pressed steel housing		<b>AELRPP2</b> .....	B172
<b>ASPF2</b> .....	B104	Square flanged unit, cast housing	
<b>ASRPF2</b> .....	B106	<b>UELFL2</b> .....	B174
Rhombus flanged unit, pressed steel housing		<b>UELFL3</b> .....	B178
<b>ASPFL2</b> .....	B108	<b>UELFU2</b> .....	B184
Hanger unit, cast housing		<b>UELFS3</b> .....	B188
<b>UCHB2</b> .....	B110	Round flanged unit, cast housing	
		<b>UELFC2</b> .....	B194

	<i>Pages</i>
Rhombus flanged unit, cast housing	
<b>UELFL2</b> .....	B198
<b>UELFL3</b> .....	B202
<b>UELFLU2</b> .....	B208
<b>AELFB2</b> .....	B212
<b>AELFD2</b> .....	B214
<b>JELFD2</b> .....	B216

Round flanged unit, pressed steel housing	
<b>AELPF2</b> .....	B218
<b>JELPF2</b> .....	B220
<b>AELRPF2</b> .....	B222

Rhombus flanged unit, pressed steel housing	
<b>AELPFL2</b> .....	B224
<b>JELPFL2</b> .....	B226

Take-up unit, cast housing	
<b>UEL2</b> .....	B228
<b>UEL3</b> .....	B232

Take-up mini stretcher units	
<b>AELPT2-</b> .....	B238
<b>JELPT2-</b> .....	B240

Cartridge unit, cast housing	
<b>UELC2</b> .....	B242
<b>UELC3</b> .....	B244

## Adapter type

Pillow block unit, cast housing	
<b>UKP2</b> .....	B248
<b>UKP3</b> .....	B252
<b>UKPX</b> .....	B256

Square flanged unit, cast housing	
<b>UKF2</b> .....	B260
<b>UKF3</b> .....	B264
<b>UKFX</b> .....	B268
<b>UKFS3</b> .....	B272

Round flanged unit, cast housing	
<b>UKFC2</b> .....	B276
<b>UKFCX</b> .....	B280

	<i>Pages</i>
Rhombus flanged unit, cast housing	
<b>UKFL2</b> .....	B284
<b>UKFL3</b> .....	B288
<b>UKFLX</b> .....	B292

Take-up unit, cast housing	
<b>UKT2</b> .....	B294
<b>UKT3</b> .....	B298
<b>UKTX</b> .....	B302

Cartridge unit, cast housing	
<b>UKC2</b> .....	B306
<b>UKC3</b> .....	B308
<b>UKCX</b> .....	B310

## Ball bearings

Set screw type	
<b>UC2</b> .....	B312
<b>UC3</b> .....	B318
<b>UCX</b> .....	B324
<b>AS2</b> .....	B328
<b>AR2</b> .....	B332

Eccentric locking collar type	
<b>UEL2</b> .....	B336
<b>UEL3</b> .....	B340
<b>AEL2</b> .....	B346
<b>JEL2</b> .....	B348
<b>REL2</b> .....	B350

Adapter type	
<b>UK2</b> .....	B354
<b>UK3</b> .....	B358
<b>UKX</b> .....	B362

Other bearings	
<b>UCS2</b> .....	B366
<b>UCS3</b> .....	B370
<b>ASS2</b> .....	B374
<b>UELS2</b> .....	B376
<b>UELS3</b> .....	B380
<b>AELS2</b> .....	B384
<b>JELS2</b> .....	B386
<b>CS2</b> .....	B388

## Pillow block unit, cast housing Set screw type

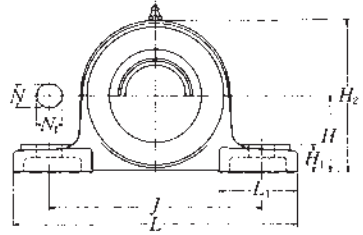
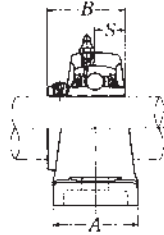
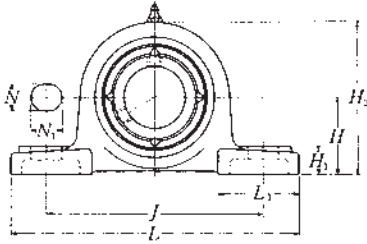

**Pressed steel dust cover type**  
Open end **Z-UCP...D1**  
Closed end **ZM-UCP...D1**

Shaft dia. mm inch	Unit number (*)	Nominal dimensions											Bolt size mm inch	Bearing number
		H	L	J	A	N	N <sub>1</sub>	H <sub>1</sub>	H <sub>2</sub>	L <sub>1</sub>	B	S		
12 1/2	<b>UCP201D1</b>	30.2	127	95	38	13	16	14	62	42	31	12.7	M10	<b>UC201D1</b>
	<b>UCP201-008D1</b>	1 3/16	5	3 3/4	1 1/2	1/2	5/8	9/16	2 7/16	1 21/32	1.2205	0.500	3/8	UC201-008D1
15 9/16 5/8	<b>UCP202D1</b>	30.2	127	95	38	13	16	14	62	42	31	12.7	M10	<b>UC202D1</b>
	<b>UCP202-009D1</b> <b>UCP202-010D1</b>	1 3/16	5	3 3/4	1 1/2	1/2	5/8	9/16	2 7/16	1 21/32	1.2205	0.500	3/8	UC202-009D1 UC202-010D1
17 1 1/16	<b>UCP203D1</b>	30.2	127	95	38	13	16	14	62	42	31	12.7	M10	<b>UC203D1</b>
	<b>UCP203-011D1</b>	1 3/16	5	3 3/4	1 1/2	1/2	5/8	9/16	2 7/16	1 21/32	1.2205	0.500	3/8	UC203-011D1
20 3/4	<b>UCP204D1</b>	33.3	127	95	38	13	16	14	65	42	31	12.7	M10	<b>UC204D1</b>
	<b>UCP204-012D1</b>	1 5/16	5	3 3/4	1 1/2	1/2	5/8	9/16	2 9/16	1 21/32	1.2205	0.500	3/8	UC204-012D1
25 1 3/16 7/8 15/16 1	<b>UCP205D1</b>	36.5	140	105	38	13	16	15	71	42	34.1	14.3	M10	<b>UC205D1</b>
	<b>UCP205-013D1</b>													UC205-013D1
	<b>UCP205-014D1</b>	1 7/16	5 1/2	4 1/8	1 1/2	1/2	5/8	19/32	2 25/32	1 21/32	1.3425	0.563	3/8	UC205-014D1
	<b>UCP205-015D1</b> <b>UCP205-100D1</b>													UC205-015D1 UC205-100D1
30 1 1/16 1 1/8 1 1/16 1 1/4	<b>UCP206D1</b>	42.9	165	121	48	17	20	17	83	54	38.1	15.9	M14	<b>UC206D1</b>
	<b>UCP206-101D1</b>													UC206-101D1
	<b>UCP206-102D1</b>	1 11/16	6 1/2	4 3/4	1 7/8	2 1/32	25/32	2 1/32	3 9/32	2 1/8	1.5000	0.626	1/2	UC206-102D1
	<b>UCP206-103D1</b> <b>UCP206-104D1</b>													UC206-103D1 UC206-104D1
35 1 1/4 1 1/16 1 3/8 1 1/16	<b>UCP207D1</b>	47.6	167	127	48	17	20	18	93	54	42.9	17.5	M14	<b>UC207D1</b>
	<b>UCP207-104D1</b>													UC207-104D1
	<b>UCP207-105D1</b>	1 7/8	6 9/16	5	1 7/8	2 1/32	25/32	23/32	3 21/32	2 1/8	1.6890	0.689	1/2	UC207-105D1
	<b>UCP207-106D1</b> <b>UCP207-107D1</b>													UC207-106D1 UC207-107D1
40 1 1/2 1 5/16	<b>UCP208D1</b>	49.2	184	137	54	17	20	18	98	52	49.2	19	M14	<b>UC208D1</b>
	<b>UCP208-108D1</b> <b>UCP208-109D1</b>	1 15/16	7 1/4	5 13/32	2 1/8	2 1/32	25/32	23/32	3 27/32	2 1/16	1.9370	0.748	1/2	UC208-108D1 UC208-109D1
45 1 5/8 1 1/16 1 3/4	<b>UCP209D1</b>	54	190	146	54	17	20	20	106	60	49.2	19	M14	<b>UC209D1</b>
	<b>UCP209-110D1</b>													UC209-110D1
	<b>UCP209-111D1</b> <b>UCP209-112D1</b>	2 1/8	7 15/32	5 3/4	2 1/8	2 1/32	25/32	25/32	4 3/16	2 3/8	1.9370	0.748	1/2	UC209-111D1 UC209-112D1

Note (\*) These numbers indicate relubricatable type. If maintenance free type is needed, please order without suffix "D1".

Remarks Please refer to page A21 for size of grease fitting.

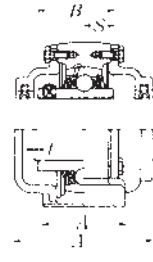
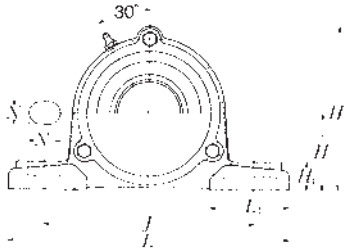

**Cast dust cover type**  
 Open end **C-UCP...D1**  
 Closed end **CM-UCP...D1**

Housing number	Unit number (1) pressed steel dust cover type	Unit number (1) cast dust cover type	Nominal dimensions				Mass of unit		
			<i>t</i> max.	<i>A</i> <sub>4</sub> mm	<i>H</i> <sub>3</sub> inch	<i>A</i> <sub>5</sub> mm	UCP	Z(ZM)	C(CM)
P203D1	<b>Z(ZM)-UCP201D1</b>	<b>C(CM)-UCP201D1</b>	2	45	67	62	0.7	0.7	1.0
P203D1	<b>Z(ZM)-UCP201-008D1</b>	<b>C(CM)-UCP201-008D1</b>	5/64	1 <sup>25</sup> / <sub>32</sub>	2 <sup>5</sup> / <sub>8</sub>	2 <sup>7</sup> / <sub>16</sub>	1.5	1.5	2.2
P203D1	<b>Z(ZM)-UCP202D1</b>	<b>C(CM)-UCP202D1</b>	2	45	67	62	0.7	0.7	1.0
P203D1	<b>Z(ZM)-UCP202-009D1</b>	<b>C(CM)-UCP202-009D1</b>	5/64	1 <sup>25</sup> / <sub>32</sub>	2 <sup>5</sup> / <sub>8</sub>	2 <sup>7</sup> / <sub>16</sub>	1.5	1.5	2.2
P203D1	<b>Z(ZM)-UCP202-010D1</b>	<b>C(CM)-UCP202-010D1</b>	5/64	1 <sup>25</sup> / <sub>32</sub>	2 <sup>5</sup> / <sub>8</sub>	2 <sup>7</sup> / <sub>16</sub>	1.5	1.5	2.2
P203D1	<b>Z(ZM)-UCP203D1</b>	<b>C(CM)-UCP203D1</b>	2	45	67	62	0.7	0.7	1.0
P203D1	<b>Z(ZM)-UCP203-011D1</b>	<b>C(CM)-UCP203-011D1</b>	5/64	1 <sup>25</sup> / <sub>32</sub>	2 <sup>5</sup> / <sub>8</sub>	2 <sup>7</sup> / <sub>16</sub>	1.5	1.5	2.2
P204D1	<b>Z(ZM)-UCP204D1</b>	<b>C(CM)-UCP204D1</b>	2	45	70	62	0.7	0.7	0.9
P204D1	<b>Z(ZM)-UCP204-012D1</b>	<b>C(CM)-UCP204-012D1</b>	5/64	1 <sup>25</sup> / <sub>32</sub>	2 <sup>3</sup> / <sub>4</sub>	2 <sup>7</sup> / <sub>16</sub>	1.5	1.5	2.0
P205D1	<b>Z(ZM)-UCP205D1</b>	<b>C(CM)-UCP205D1</b>	2	48	76	70	0.8	0.9	1.1
P205D1	<b>Z(ZM)-UCP205-013D1</b>	<b>C(CM)-UCP205-013D1</b>	5/64	1 <sup>29</sup> / <sub>32</sub>	3	2 <sup>3</sup> / <sub>4</sub>	1.8	2.0	2.4
P205D1	<b>Z(ZM)-UCP205-014D1</b>	<b>C(CM)-UCP205-014D1</b>	5/64	1 <sup>29</sup> / <sub>32</sub>	3	2 <sup>3</sup> / <sub>4</sub>	1.8	2.0	2.4
P205D1	<b>Z(ZM)-UCP205-015D1</b>	<b>C(CM)-UCP205-015D1</b>	5/64	1 <sup>29</sup> / <sub>32</sub>	3	2 <sup>3</sup> / <sub>4</sub>	1.8	2.0	2.4
P205D1	<b>Z(ZM)-UCP205-100D1</b>	<b>C(CM)-UCP205-100D1</b>	5/64	1 <sup>29</sup> / <sub>32</sub>	3	2 <sup>3</sup> / <sub>4</sub>	1.8	2.0	2.4
P206D1	<b>Z(ZM)-UCP206D1</b>	<b>C(CM)-UCP206D1</b>	2	53	88	75	1.4	1.4	1.7
P206D1	<b>Z(ZM)-UCP206-101D1</b>	<b>C(CM)-UCP206-101D1</b>	5/64	2 <sup>3</sup> / <sub>32</sub>	3 <sup>15</sup> / <sub>32</sub>	2 <sup>15</sup> / <sub>16</sub>	3.1	3.1	3.7
P206D1	<b>Z(ZM)-UCP206-102D1</b>	<b>C(CM)-UCP206-102D1</b>	5/64	2 <sup>3</sup> / <sub>32</sub>	3 <sup>15</sup> / <sub>32</sub>	2 <sup>15</sup> / <sub>16</sub>	3.1	3.1	3.7
P206D1	<b>Z(ZM)-UCP206-103D1</b>	<b>C(CM)-UCP206-103D1</b>	5/64	2 <sup>3</sup> / <sub>32</sub>	3 <sup>15</sup> / <sub>32</sub>	2 <sup>15</sup> / <sub>16</sub>	3.1	3.1	3.7
P206D1	–	–	–	–	–	–	–	–	–
P207D1	<b>Z(ZM)-UCP207D1</b>	<b>C(CM)-UCP207D1</b>	3	60	99	80	1.6	1.7	2.0
P207D1	<b>Z(ZM)-UCP207-104D1</b>	<b>C(CM)-UCP207-104D1</b>	1/8	2 <sup>3</sup> / <sub>8</sub>	3 <sup>29</sup> / <sub>32</sub>	3 <sup>5</sup> / <sub>32</sub>	3.5	3.7	4.4
P207D1	<b>Z(ZM)-UCP207-105D1</b>	<b>C(CM)-UCP207-105D1</b>	1/8	2 <sup>3</sup> / <sub>8</sub>	3 <sup>29</sup> / <sub>32</sub>	3 <sup>5</sup> / <sub>32</sub>	3.5	3.7	4.4
P207D1	<b>Z(ZM)-UCP207-106D1</b>	<b>C(CM)-UCP207-106D1</b>	1/8	2 <sup>3</sup> / <sub>8</sub>	3 <sup>29</sup> / <sub>32</sub>	3 <sup>5</sup> / <sub>32</sub>	3.5	3.7	4.4
P207D1	–	–	–	–	–	–	–	–	–
P208D1	<b>Z(ZM)-UCP208D1</b>	<b>C(CM)-UCP208D1</b>	3	69	105	90	1.9	2.1	2.7
P208D1	<b>Z(ZM)-UCP208-108D1</b>	<b>C(CM)-UCP208-108D1</b>	1/8	2 <sup>29</sup> / <sub>32</sub>	4 <sup>1</sup> / <sub>8</sub>	3 <sup>17</sup> / <sub>32</sub>	4.2	4.6	6.0
P208D1	<b>Z(ZM)-UCP208-109D1</b>	<b>C(CM)-UCP208-109D1</b>	1/8	2 <sup>29</sup> / <sub>32</sub>	4 <sup>1</sup> / <sub>8</sub>	3 <sup>17</sup> / <sub>32</sub>	4.2	4.6	6.0
P209D1	<b>Z(ZM)-UCP209D1</b>	<b>C(CM)-UCP209D1</b>	3	69	113	95	2.2	2.4	3.1
P209D1	<b>Z(ZM)-UCP209-110D1</b>	<b>C(CM)-UCP209-110D1</b>	1/8	2 <sup>29</sup> / <sub>32</sub>	4 <sup>7</sup> / <sub>16</sub>	3 <sup>3</sup> / <sub>4</sub>	4.9	5.3	6.8
P209D1	<b>Z(ZM)-UCP209-111D1</b>	<b>C(CM)-UCP209-111D1</b>	1/8	2 <sup>29</sup> / <sub>32</sub>	4 <sup>7</sup> / <sub>16</sub>	3 <sup>3</sup> / <sub>4</sub>	4.9	5.3	6.8
P209D1	<b>Z(ZM)-UCP209-112D1</b>	<b>C(CM)-UCP209-112D1</b>	1/8	2 <sup>29</sup> / <sub>32</sub>	4 <sup>7</sup> / <sub>16</sub>	3 <sup>3</sup> / <sub>4</sub>	4.9	5.3	6.8

## Pillow block unit, cast housing Set screw type

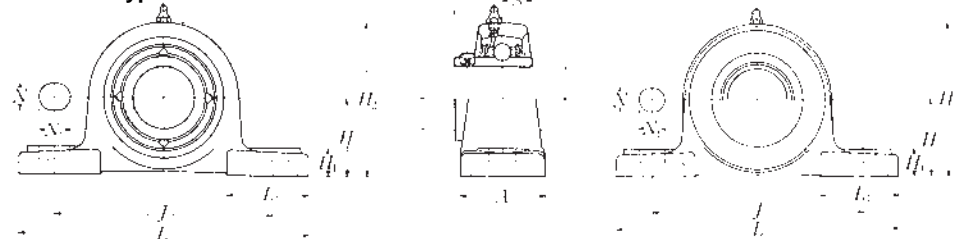

### Pressed steel dust cover type

Open end **Z-UCP...D1**

Closed end **ZM-UCP...D1**

Shaft dia. mm inch	Unit number (*)	Nominal dimensions											Bolt size mm inch	Bearing number
		H	L	J	A	N	N <sub>1</sub>	H <sub>1</sub>	H <sub>2</sub>	L <sub>1</sub>	B	S		
50 1 3/16 1 1/8 1 5/16 2	<b>UCP210D1</b> <b>UCP210-113D1</b> <b>UCP210-114D1</b> <b>UCP210-115D1</b> <b>UCP210-200D1</b>	57.2	206	159	60	20	23	21	114	65	51.6	19	M16	<b>UC210D1</b> UC210-113D1 UC210-114D1 UC210-115D1 UC210-200D1
55 2 2 1/16 2 1/8 2 3/16	<b>UCP211D1</b> <b>UCP211-200D1</b> <b>UCP211-201D1</b> <b>UCP211-202D1</b> <b>UCP211-203D1</b>	63.5	219	171	60	20	23	23	126	65	55.6	22.2	M16	<b>UC211D1</b> UC211-200D1 UC211-201D1 UC211-202D1 UC211-203D1
60 2 1/4 2 1/16 2 3/8 2 7/16	<b>UCP212D1</b> <b>UCP212-204D1</b> <b>UCP212-205D1</b> <b>UCP212-206D1</b> <b>UCP212-207D1</b>	69.8	241	184	70	20	23	25	138	70	65.1	25.4	M16	<b>UC212D1</b> UC212-204D1 UC212-205D1 UC212-206D1 UC212-207D1
65 2 1/2 2 3/16	<b>UCP213D1</b> <b>UCP213-208D1</b> <b>UCP213-209D1</b>	76.2	265	203	70	25	28	27	151	77	65.1	25.4	M20	<b>UC213D1</b> UC213-208D1 UC213-209D1
70 2 5/8 2 1/16 2 3/4	<b>UCP214D1</b> <b>UCP214-210D1</b> <b>UCP214-211D1</b> <b>UCP214-212D1</b>	79.4	266	210	72	25	28	27	157	77	74.6	30.2	M20	<b>UC214D1</b> UC214-210D1 UC214-211D1 UC214-212D1
75 2 3/16 2 7/8 2 1/16 3	<b>UCP215D1</b> <b>UCP215-213D1</b> <b>UCP215-214D1</b> <b>UCP215-215D1</b> <b>UCP215-300D1</b>	82.6	275	217	74	25	28	28	163	80	77.8	33.3	M20	<b>UC215D1</b> UC215-213D1 UC215-214D1 UC215-215D1 UC215-300D1
80 3 1/16 3 1/8 3 3/16	<b>UCP216D1</b> <b>UCP216-301D1</b> <b>UCP216-302D1</b> <b>UCP216-303D1</b>	88.9	292	232	78	25	28	30	175	85	82.6	33.3	M20	<b>UC216D1</b> UC216-301D1 UC216-302D1 UC216-303D1

Note (\*) These numbers indicate relubricatable type. If maintenance free type is needed, please order without suffix "D1".

Remarks Please refer to page A21 for size of grease fitting.

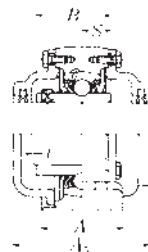
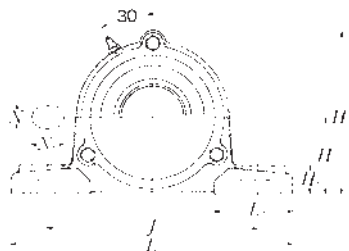

**Cast dust cover type**  
 Open end **C-UCP...D1**  
 Closed end **CM-UCP...D1**

Housing number	Unit number (1) pressed steel dust cover type	Unit number (1) cast dust cover type	Nominal dimensions				Mass of unit		
			<i>t</i> max.	<i>A</i> <sub>4</sub>	<i>H</i> <sub>3</sub>	<i>A</i> <sub>5</sub>	UCP	Z(ZM)	C(CM)
P210D1	<b>Z(ZM)-UCP210D1</b>	<b>C(CM)-UCP210D1</b>	3	76	119	100	2.7	2.8	3.6
P210D1	<b>Z(ZM)-UCP210-113D1</b>	<b>C(CM)-UCP210-113D1</b>	1/8	3	4 11/16	3 5/16	6.0	6.2	7.9
P210D1	<b>Z(ZM)-UCP210-114D1</b>	<b>C(CM)-UCP210-114D1</b>							
P210D1	<b>Z(ZM)-UCP210-115D1</b>	<b>C(CM)-UCP210-115D1</b>							
P210D1	–	<b>C(CM)-UCP210-200D1</b>							
P211D1	<b>Z(ZM)-UCP211D1</b>	<b>C(CM)-UCP211D1</b>	4	77	130	100	3.5	3.5	4.4
P211D1	<b>Z(ZM)-UCP211-200D1</b>	<b>C(CM)-UCP211-200D1</b>	5/32	3 1/2	5 1/8	3 15/16	7.7	7.7	9.7
P211D1	<b>Z(ZM)-UCP211-201D1</b>	<b>C(CM)-UCP211-201D1</b>							
P211D1	<b>Z(ZM)-UCP211-202D1</b>	<b>C(CM)-UCP211-202D1</b>							
P211D1	<b>Z(ZM)-UCP211-203D1</b>	<b>C(CM)-UCP211-203D1</b>							
P212D1	<b>Z(ZM)-UCP212D1</b>	<b>C(CM)-UCP212D1</b>	4	89	143	115	4.7	5.0	6.0
P212D1	<b>Z(ZM)-UCP212-204D1</b>	<b>C(CM)-UCP212-204D1</b>	5/32	3 1/2	5 5/8	4 17/32	10	11	13
P212D1	<b>Z(ZM)-UCP212-205D1</b>	<b>C(CM)-UCP212-205D1</b>							
P212D1	<b>Z(ZM)-UCP212-206D1</b>	<b>C(CM)-UCP212-206D1</b>							
P212D1	–	<b>C(CM)-UCP212-207D1</b>							
P213D1	<b>Z(ZM)-UCP213D1</b>	<b>C(CM)-UCP213D1</b>	4	91	155	120	5.6	5.8	7.2
P213D1	<b>Z(ZM)-UCP213-208D1</b>	<b>C(CM)-UCP213-208D1</b>	5/32	3 19/32	6 3/32	4 23/32	12	13	16
P213D1	<b>Z(ZM)-UCP213-209D1</b>	<b>C(CM)-UCP213-209D1</b>							
P214D1	–	<b>C(CM)-UCP214D1</b>	4	–	162	135	6.5	–	8.3
P214D1	–	<b>C(CM)-UCP214-210D1</b>	5/32	–	6 3/8	5 5/16	14	–	18
P214D1	–	<b>C(CM)-UCP214-211D1</b>							
P214D1	–	<b>C(CM)-UCP214-212D1</b>							
P215D1	–	<b>C(CM)-UCP215D1</b>	4	–	168	135	7.2	–	9.3
P215D1	–	<b>C(CM)-UCP215-213D1</b>	5/32	–	6 5/8	5 5/16	16	–	21
P215D1	–	<b>C(CM)-UCP215-214D1</b>							
P215D1	–	<b>C(CM)-UCP215-215D1</b>							
P215D1	–	<b>C(CM)-UCP215-300D1</b>							
P216D1	–	<b>C(CM)-UCP216D1</b>	4	–	181	145	8.7	–	11
P216D1	–	<b>C(CM)-UCP216-301D1</b>	5/32	–	7 1/8	5 23/32	19	–	24
P216D1	–	<b>C(CM)-UCP216-302D1</b>							
P216D1	–	<b>C(CM)-UCP216-303D1</b>							

## Pillow block unit, cast housing Set screw type

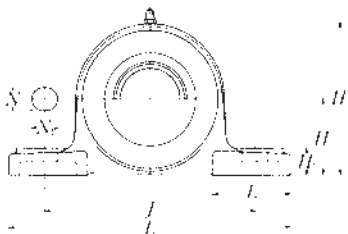
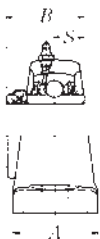
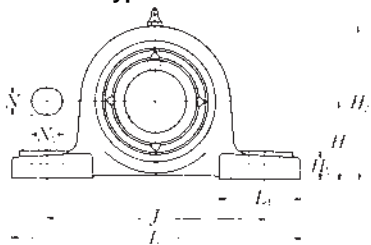

### Pressed steel dust cover type

Open end **Z-UCP...D1**

Closed end **ZM-UCP...D1**

Shaft dia. mm inch	Unit number (1)	Nominal dimensions mm inch											Bolt size mm inch	Bearing number
		H	L	J	A	N	N <sub>1</sub>	H <sub>1</sub>	H <sub>2</sub>	L <sub>1</sub>	B	S		
85 3 1/4	<b>UCP217D1</b>	95.2	310	247	83	25	28	32	187	85	85.7	34.1	M20	<b>UC217D1</b>
3 1/8	<b>UCP217-304D1</b>													UC217-304D1
3 5/16	<b>UCP217-305D1</b>	3 3/4	12 7/32	9 29/32	3 3/32	3 1/32	1 3/32	1 1/4	7 3/8	3 11/32	3.3740	1.343	3/4	UC217-305D1
3 7/16	<b>UCP217-307D1</b>													UC217-307D1
90 3 1/2	<b>UCP218D1</b>	101.6	327	262	88	27	30	33	200	90	96	39.7	M22	<b>UC218D1</b>
	<b>UCP218-308D1</b>	4	12 7/8	10 5/16	3 15/32	1 1/16	1 3/16	1 5/16	7 7/8	3 17/32	3.7795	1.563	7/8	UC218-308D1

**Note (1)** These numbers indicate relubricatable type. If maintenance free type is needed, please order without suffix "D1".

**Remarks** Please refer to page **A21** for size of grease fitting.

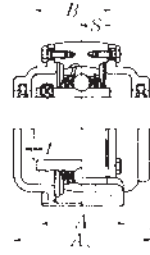
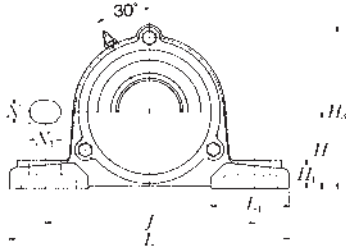
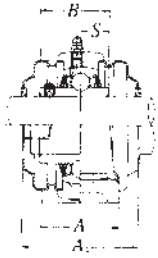

**Cast dust cover type**  
 Open end **C-UCP...D1**  
 Closed end **CM-UCP...D1**

Housing number	Unit number (1) pressed steel dust cover type	Unit number (1) cast dust cover type	Nominal dimensions				Mass of unit		
			<i>t</i> max.	<i>A</i> <sub>4</sub>	<i>H</i> <sub>3</sub>	<i>A</i> <sub>5</sub>	UCP	Z(ZM)	C(CM)
P217D1	—	<b>C(CM)-UCP217D1</b>	5	—	191	155	11	—	13
P217D1	—	<b>C(CM)-UCP217-304D1</b>	$\frac{13}{64}$	—	$7\frac{17}{32}$	$6\frac{3}{32}$	24	—	29
P217D1	—	<b>C(CM)-UCP217-305D1</b>							
P217D1	—	<b>C(CM)-UCP217-307D1</b>							
P218D1	—	<b>C(CM)-UCP218D1</b>	5	—	204	165	13	—	16
P218D1	—	<b>C(CM) UCP218-308D1</b>	$\frac{13}{64}$	—	$8\frac{1}{2}$	$6\frac{1}{2}$	29	—	35



## Pillow block unit, cast housing Set screw type

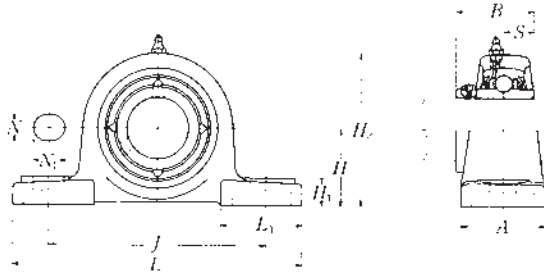

Shaft dia. mm inch	Unit number (1)	Nominal dimensions											Bolt size mm inch
		mm inch											
		H	L	J	A	N	N <sub>1</sub>	H <sub>1</sub>	H <sub>2</sub>	L <sub>1</sub>	B	S	
25 1 3/16 7/8 15/16	<b>UCP305D1</b> <b>UCP305-013D1</b> <b>UCP305-014D1</b> <b>UCP305-015D1</b> <b>UCP305-100D1</b>	45 1 49/64	175 6 7/8	132 5 3/16	45 1 25/32	17 2 1/32	20 2 5/32	15 1 9/32	85 3 11/32	54 2 1/8	38 1.4961	15 0.591	M14 1/2
30 1 1/16 1 1/8 1 3/16	<b>UCP306D1</b> <b>UCP306-101D1</b> <b>UCP306-102D1</b> <b>UCP306-103D1</b>	50 1 31/32	180 7 3/32	140 5 1/2	50 1 31/32	17 2 1/32	20 2 5/32	18 2 3/32	95 3 3/4	54 2 1/8	43 1.6929	17 0.669	M14 1/2
35 1 1/4 1 5/16 1 3/8 1 7/16	<b>UCP307D1</b> <b>UCP307-104D1</b> <b>UCP307-105D1</b> <b>UCP307-106D1</b> <b>UCP307-107D1</b>	56 2 13/64	210 8 3/32	160 6 5/16	56 2 7/32	17 2 1/32	25 3 1/32	20 2 5/32	106 4 3/16	60 2 3/8	48 1.8898	19 0.748	M14 1/2
40 1 1/2 1 9/16	<b>UCP308D1</b> <b>UCP308-108D1</b> <b>UCP308-109D1</b>	60 2 23/64	220 8 21/32	170 6 11/16	60 2 3/8	17 2 1/32	27 1 1/16	22 7/8	116 4 9/16	60 2 3/8	52 2.0472	19 0.748	M14 1/2
45 1 5/8 1 11/16 1 3/4	<b>UCP309D1</b> <b>UCP309-110D1</b> <b>UCP309-111D1</b> <b>UCP309-112D1</b>	67 2 41/64	245 9 21/32	190 7 15/32	67 2 5/8	20 2 5/32	30 1 3/16	24 1 5/16	129 5 3/32	65 2 9/16	57 2.2441	22 0.866	M16 5/8
50 1 13/16 1 7/8 1 15/16	<b>UCP310D1</b> <b>UCP310-113D1</b> <b>UCP310-114D1</b> <b>UCP310-115D1</b>	75 2 61/64	275 10 13/16	212 8 11/32	75 2 15/16	20 2 5/32	35 1 3/8	27 1 1/16	143 5 5/8	75 2 15/16	61 2.4016	22 0.866	M16 5/8
55 2 2 1/16 2 1/8 2 3/16	<b>UCP311D1</b> <b>UCP311-200D1</b> <b>UCP311-201D1</b> <b>UCP311-202D1</b> <b>UCP311-203D1</b>	80 3 5/32	310 12 7/32	236 9 9/32	80 3 5/32	20 2 5/32	38 1 1/2	30 1 3/16	154 6 1/16	85 3 11/32	66 2.5984	25 0.984	M16 5/8

Note (1) These numbers indicate relubricatable type. If maintenance free type is needed, please order without suffix "D1".

Remarks Please refer to page A21 for size of grease fitting.

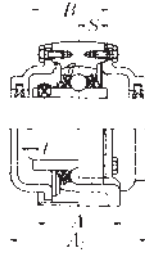
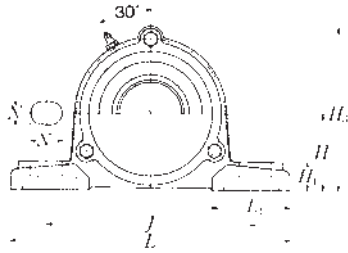

**Cast dust cover type**  
 Open end **C-UCP...D1**  
 Closed end **CM-UCP...D1**

Bearing number	Housing number	Unit number (1) cast dust cover type	Nominal dimensions			Mass of unit	
			t max.	H <sub>3</sub>	A <sub>5</sub>	kg	lb
UC305D1	P305D1	<b>C(CM)-UCP305D1</b>	2	91	80	1.4	1.8
UC305-013D1	P305D1	<b>C(CM)-UCP305-013D1</b>					
UC305-014D1	P305D1	<b>C(CM)-UCP305-014D1</b>					
UC305-015D1	P305D1	<b>C(CM)-UCP305-015D1</b>	5/64	3 19/32	3 5/32	3.1	4.0
UC305-100D1	P305D1	<b>C(CM)-UCP305-100D1</b>					
UC306D1	P306D1	<b>C(CM)-UCP306D1</b>	2	105	85	1.8	2.5
UC306-101D1	P306D1	<b>C(CM)-UCP306-101D1</b>					
UC306-102D1	P306D1	<b>C(CM)-UCP306-102D1</b>					
UC306-103D1	P306D1	<b>C(CM)-UCP306-103D1</b>	5/64	4 1/8	3 11/32	4.0	5.5
UC307D1	P307D1	<b>C(CM)-UCP307D1</b>	3	115	95	2.5	3.2
UC307-104D1	P307D1	<b>C(CM)-UCP307-104D1</b>					
UC307-105D1	P307D1	<b>C(CM)-UCP307-105D1</b>					
UC307-106D1	P307D1	<b>C(CM)-UCP307-106D1</b>					
UC307-107D1	P307D1	<b>C(CM)-UCP307-107D1</b>	1/8	4 17/32	3 3/4	5.5	7.1
UC308D1	P308D1	<b>C(CM)-UCP308D1</b>	3	125	105	3.1	4.0
UC308-108D1	P308D1	<b>C(CM)-UCP308-108D1</b>					
UC308-109D1	P308D1	<b>C(CM)-UCP308-109D1</b>	1/8	4 29/32	4 1/8	6.8	8.8
UC309D1	P309D1	<b>C(CM)-UCP309D1</b>	3	140	110	4.1	5.4
UC309-110D1	P309D1	<b>C(CM)-UCP309-110D1</b>					
UC309-111D1	P309D1	<b>C(CM)-UCP309-111D1</b>					
UC309-112D1	P309D1	<b>C(CM)-UCP309-112D1</b>	1/8	5 1/2	4 11/32	9.0	12
UC310D1	P310D1	<b>C(CM)-UCP310D1</b>	3	156	120	5.6	7.0
UC310-113D1	P310D1	<b>C(CM)-UCP310-113D1</b>					
UC310-114D1	P310D1	<b>C(CM)-UCP310-114D1</b>					
UC310-115D1	P310D1	<b>C(CM)-UCP310-115D1</b>	1/8	6 5/32	4 23/32	12	15
UC311D1	P311D1	<b>C(CM)-UCP311D1</b>	4	166	125	7.3	8.8
UC311-200D1	P311D1	<b>C(CM)-UCP311-200D1</b>					
UC311-201D1	P311D1	<b>C(CM)-UCP311-201D1</b>					
UC311-202D1	P311D1	<b>C(CM)-UCP311-202D1</b>					
UC311-203D1	P311D1	<b>C(CM)-UCP311-203D1</b>	5/32	6 17/32	4 29/32	16	19

## Pillow block unit, cast housing Set screw type

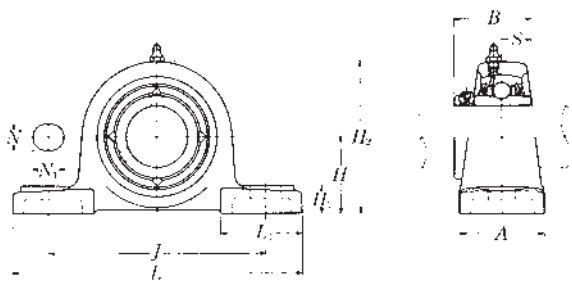

Shaft dia. mm inch	Unit number (1)	Nominal dimensions											Bolt size mm inch
		mm inch											
		H	L	J	A	N	N <sub>1</sub>	H <sub>1</sub>	H <sub>2</sub>	L <sub>1</sub>	B	S	
60 2 1/4 2 5/16 2 3/8 2 7/16	<b>UCP312D1</b> <b>UCP312-204D1</b> <b>UCP312-205D1</b> <b>UCP312-206D1</b> <b>UCP312-207D1</b>	85	330	250	85	25	38	32	165	95	71	26	M20
		3 11/32	13	9 27/32	3 11/32	3 1/2	1 1/2	1 1/4	6 1/2	3 3/4	2.7953	1.024	3/4
65 2 1/2 2 9/16	<b>UCP313D1</b> <b>UCP313-208D1</b> <b>UCP313-209D1</b>	90	340	260	90	25	38	33	176	105	75	30	M20
		3 35/64	13 3/8	10 1/4	3 17/32	3 1/2	1 1/2	1 5/16	6 15/16	4 1/8	2.9528	1.181	3/4
70 2 5/8 2 7/16 2 3/4	<b>UCP314D1</b> <b>UCP314-210D1</b> <b>UCP314-211D1</b> <b>UCP314-212D1</b>	95	360	280	90	27	40	35	187	105	78	33	M22
		3 47/64	14 3/16	11 1/32	3 17/32	1 1/16	1 9/16	1 3/8	7 3/8	4 1/8	3.0709	1.299	7/8
75 2 13/16 2 7/8 2 5/16 3	<b>UCP315D1</b> <b>UCP315-213D1</b> <b>UCP315-214D1</b> <b>UCP315-215D1</b> <b>UCP315-300D1</b>	100	380	290	100	27	40	35	198	110	82	32	M22
		3 15/16	14 31/32	11 13/32	3 15/16	1 1/16	1 9/16	1 3/8	7 25/32	4 11/32	3.2283	1.260	7/8
80 3 1/16 3 1/8 3 7/16	<b>UCP316D1</b> <b>UCP316-301D1</b> <b>UCP316-302D1</b> <b>UCP316-303D1</b>	106	400	300	110	27	40	40	210	110	86	34	M22
		4 11/64	15 3/4	11 13/16	4 11/32	1 1/16	1 9/16	1 9/16	8 9/32	4 11/32	3.3858	1.339	7/8
85 3 3/4 3 5/16 3 7/16	<b>UCP317D1</b> <b>UCP317-304D1</b> <b>UCP317-305D1</b> <b>UCP317-307D1</b>	112	420	320	110	33	45	40	220	120	96	40	M27
		4 13/32	16 17/32	12 19/32	4 11/32	1 5/16	1 25/32	1 9/16	8 21/32	4 23/32	3.7795	1.575	1
90 3 7/16 3 1/2	<b>UCP318D1</b> <b>UCP318-307D1</b> <b>UCP318-308D1</b>	118	430	330	110	33	45	45	235	120	96	40	M27
		4 41/64	16 15/16	13	4 11/32	1 5/16	1 25/32	1 25/32	9 1/4	4 23/32	3.7795	1.575	1

Note (1) These numbers indicate relubricatable type. If maintenance free type is needed, please order without suffix "D1".

Remarks Please refer to page A21 for size of grease fitting.

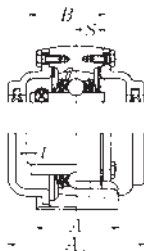
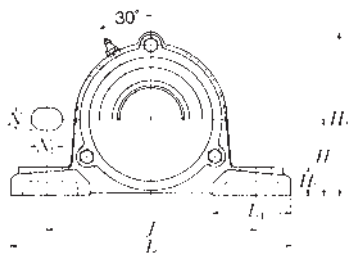

**Cast dust cover type**  
 Open end **C-UCP...D1**  
 Closed end **CM-UCP...D1**

Bearing number	Housing number	Unit number (1) cast dust cover type	Nominal dimensions			Mass of unit	
			t max.	H <sub>3</sub>	A <sub>5</sub>	UCP	C(CM)
UC312D1	P312D1	<b>C(CM)-UCP312D1</b>	4	179	135	9.4	11
UC312-204D1	P312D1	<b>C(CM)-UCP312-204D1</b>					
UC312-205D1	P312D1	<b>C(CM)-UCP312-205D1</b>	5/32	7 1/16	5 5/16	21	24
UC312-206D1	P312D1	<b>C(CM)-UCP312-206D1</b>					
UC312-207D1	P312D1	<b>C(CM)-UCP312-207D1</b>					
UC313D1	P313D1	<b>C(CM)-UCP313D1</b>	4	190	140	10	12
UC313-208D1	P313D1	<b>C(CM)-UCP313-208D1</b>					
UC313-209D1	P313D1	<b>C(CM)-UCP313-209D1</b>	5/32	7 15/32	5 1/2	22	26
UC314D1	P314D1	<b>C(CM)-UCP314D1</b>	4	200	140	12	14
UC314-210D1	P314D1	<b>C(CM)-UCP314-210D1</b>					
UC314-211D1	P314D1	<b>C(CM)-UCP314-211D1</b>	5/32	7 7/8	5 1/2	26	31
UC314-212D1	P314D1	<b>C(CM)-UCP314-212D1</b>					
UC315D1	P315D1	<b>C(CM)-UCP315D1</b>	4	210	150	14	17
UC315-213D1	P315D1	<b>C(CM)-UCP315-213D1</b>					
UC315-214D1	P315D1	<b>C(CM)-UCP315-214D1</b>					
UC315-215D1	P315D1	<b>C(CM)-UCP315-215D1</b>	5/32	8 9/32	5 29/32	31	37
UC315-300D1	P315D1	<b>C(CM)-UCP315-300D1</b>					
UC316D1	P316D1	<b>C(CM)-UCP316D1</b>	4	221	155	17	21
UC316-301D1	P316D1	<b>C(CM)-UCP316-301D1</b>					
UC316-302D1	P316D1	<b>C(CM)-UCP316-302D1</b>	5/32	8 11/16	6 3/32	37	46
UC316-303D1	P316D1	<b>C(CM)-UCP316-303D1</b>					
UC317D1	P317D1	<b>C(CM)-UCP317D1</b>	5	235	170	19	24
UC317-304D1	P317D1	<b>C(CM)-UCP317-304D1</b>					
UC317-305D1	P317D1	<b>C(CM)-UCP317-305D1</b>	13/64	9 1/4	6 11/16	42	53
UC317-307D1	P317D1	<b>C(CM)-UCP317-307D1</b>					
UC318D1	P318D1	<b>C(CM)-UCP318D1</b>	5	246	170	22	27
UC318-307D1	P318D1	<b>C(CM)-UCP318-307D1</b>					
UC318-308D1	P318D1	<b>C(CM)-UCP318-308D1</b>	13/64	9 1/16	6 11/16	49	60

## Pillow block unit, cast housing Set screw type

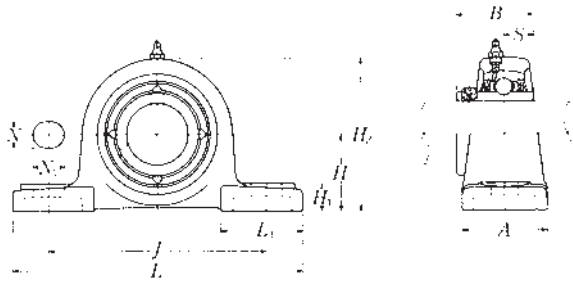

Shaft dia. mm inch	Unit number (1)	Nominal dimensions											Bolt size mm inch
		mm inch											
		<i>H</i>	<i>L</i>	<i>J</i>	<i>A</i>	<i>N</i>	<i>N</i> <sub>1</sub>	<i>H</i> <sub>1</sub>	<i>H</i> <sub>2</sub>	<i>L</i> <sub>1</sub>	<i>B</i>	<i>S</i>	
95 3 <sup>5</sup> / <sub>8</sub> 3 <sup>1</sup> / <sub>16</sub> 3 <sup>3</sup> / <sub>4</sub>	<b>UCP319D1</b> <b>UCP319-310D1</b> <b>UCP319-311D1</b> <b>UCP319-312D1</b>	125 4 <sup>59</sup> / <sub>64</sub>	470 18 <sup>1</sup> / <sub>2</sub>	360 14 <sup>3</sup> / <sub>16</sub>	120 4 <sup>23</sup> / <sub>32</sub>	36 1 <sup>13</sup> / <sub>32</sub>	50 1 <sup>31</sup> / <sub>32</sub>	45 1 <sup>25</sup> / <sub>32</sub>	250 9 <sup>27</sup> / <sub>32</sub>	125 4 <sup>29</sup> / <sub>32</sub>	103 4.0551	41 1.614	M30 1 <sup>1</sup> / <sub>8</sub>
100 3 <sup>13</sup> / <sub>16</sub> 3 <sup>7</sup> / <sub>8</sub> 3 <sup>15</sup> / <sub>16</sub> 4	<b>UCP320D1</b> <b>UCP320-313D1</b> <b>UCP320-314D1</b> <b>UCP320-315D1</b> <b>UCP320-400D1</b>	140 5 <sup>33</sup> / <sub>64</sub>	490 19 <sup>9</sup> / <sub>32</sub>	380 14 <sup>31</sup> / <sub>32</sub>	120 4 <sup>23</sup> / <sub>32</sub>	36 1 <sup>13</sup> / <sub>32</sub>	50 1 <sup>31</sup> / <sub>32</sub>	50 1 <sup>31</sup> / <sub>32</sub>	275 10 <sup>13</sup> / <sub>16</sub>	130 5 <sup>1</sup> / <sub>8</sub>	108 4.2520	42 1.654	M30 1 <sup>1</sup> / <sub>8</sub>
105	<b>UCP321D1</b>	140	490	380	120	36	50	50	280	130	112	44	M30
110	<b>UCP322D1</b>	150	520	400	140	40	55	55	300	135	117	46	M33
120	<b>UCP324D1</b>	160	570	450	140	40	55	65	320	140	126	51	M33
130	<b>UCP326D1</b>	180	600	480	140	40	55	75	355	140	135	54	M33
140	<b>UCP328D1</b>	200	620	500	140	40	55	75	390	140	145	59	M33

**Note (1)** These numbers indicate relubricatable type. If maintenance free type is needed, please order without suffix "D1".

**Remarks** Please refer to page **A21** for size of grease fitting.

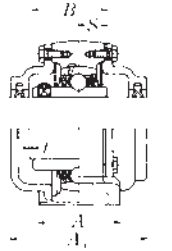
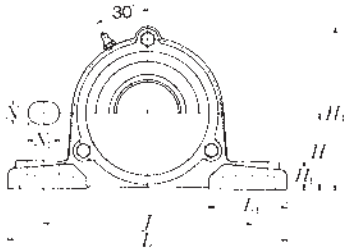

**Cast dust cover type**  
 Open end **C-UCP...D1**  
 Closed end **CM-UCP...D1**

Bearing number	Housing number	Unit number (1) cast dust cover type	Nominal dimensions			Mass of unit	
			<i>t</i> max.	<i>H</i> <sub>3</sub>	<i>A</i> <sub>5</sub>	kg	lb
			mm	inch		UCP	C(CM)
UC319D1	P319D1	<b>C(CM)-UCP319D1</b>	5	258	180	26	32
UC319-310D1	P319D1	<b>C(CM)-UCP319-310D1</b>					
UC319-311D1	P319D1	<b>C(CM)-UCP319-311D1</b>	1 <sup>3</sup> / <sub>64</sub>	10 <sup>5</sup> / <sub>32</sub>	7 <sup>3</sup> / <sub>32</sub>	57	71
UC319-312D1	P319D1	<b>C(CM)-UCP319-312D1</b>					
UC320D1	P320D1	<b>C(CM)-UCP320D1</b>	5	283	190	33	39
UC320-313D1	P320D1	<b>C(CM)-UCP320-313D1</b>					
UC320-314D1	P320D1	<b>C(CM)-UCP320-314D1</b>					
UC320-315D1	P320D1	<b>C(CM)-UCP320-315D1</b>	1 <sup>3</sup> / <sub>64</sub>	11 <sup>5</sup> / <sub>32</sub>	7 <sup>15</sup> / <sub>32</sub>	73	86
UC320-400D1	P320D1	<b>C(CM)-UCP320-400D1</b>					
UC321D1	P321D1	<b>C(CM)-UCP321D1</b>	5	290	195	35	42
UC322D1	P322D1	<b>C(CM)-UCP322D1</b>	5	313	200	43	52
UC324D1	P324D1	<b>C(CM)-UCP324D1</b>	5	335	215	50	67
UC326D1	P326D1	<b>C(CM)-UCP326D1</b>	6	375	225	69	83
UC328D1	P328D1	<b>C(CM)-UCP328D1</b>	6	407	235	84	99

## Pillow block unit, cast housing Set screw type

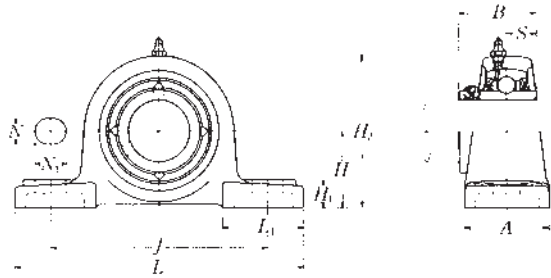

Shaft dia. mm inch	Unit number (1)	Nominal dimensions											Bolt size mm inch
		H	L	J	A	N	N <sub>1</sub>	H <sub>1</sub>	H <sub>2</sub>	L <sub>1</sub>	B	S	
25 1 <sup>3</sup> / <sub>16</sub> 7/ <sub>8</sub> 1 <sup>5</sup> / <sub>16</sub>	<b>UCPX05D1</b> <b>UCPX05-013D1</b> <b>UCPX05-014D1</b> <b>UCPX05-015D1</b> <b>UCPX05-100D1</b>	44.4	159	119	51	17	20	18	85	50	38.1	15.9	M14
1		1 <sup>3</sup> / <sub>4</sub>	6 <sup>1</sup> / <sub>4</sub>	4 <sup>11</sup> / <sub>16</sub>	2	2 <sup>1</sup> / <sub>32</sub>	2 <sup>5</sup> / <sub>32</sub>	2 <sup>3</sup> / <sub>32</sub>	3 <sup>11</sup> / <sub>32</sub>	1 <sup>31</sup> / <sub>32</sub>	1.5000	0.626	1/2
30 1 <sup>1</sup> / <sub>16</sub> 1 <sup>1</sup> / <sub>8</sub> 1 <sup>3</sup> / <sub>16</sub> 1 <sup>1</sup> / <sub>4</sub>	<b>UCPX06D1</b> <b>UCPX06-101D1</b> <b>UCPX06-102D1</b> <b>UCPX06-103D1</b> <b>UCPX06-104D1</b>	47.6	175	127	57	17	20	20	93	54	42.9	17.5	M14
		1 <sup>7</sup> / <sub>8</sub>	6 <sup>7</sup> / <sub>8</sub>	5	2 <sup>1</sup> / <sub>4</sub>	2 <sup>1</sup> / <sub>32</sub>	2 <sup>5</sup> / <sub>32</sub>	2 <sup>5</sup> / <sub>32</sub>	3 <sup>21</sup> / <sub>32</sub>	2 <sup>7</sup> / <sub>8</sub>	1.6890	0.689	1/2
35 1 <sup>5</sup> / <sub>16</sub> 1 <sup>3</sup> / <sub>8</sub> 1 <sup>7</sup> / <sub>16</sub>	<b>UCPX07D1</b> <b>UCPX07-105D1</b> <b>UCPX07-106D1</b> <b>UCPX07-107D1</b>	54	203	144	57	17	20	21	105	60	49.2	19	M14
		2 <sup>1</sup> / <sub>8</sub>	8	5 <sup>21</sup> / <sub>32</sub>	2 <sup>1</sup> / <sub>4</sub>	2 <sup>1</sup> / <sub>32</sub>	2 <sup>5</sup> / <sub>32</sub>	1 <sup>9</sup> / <sub>16</sub>	4 <sup>1</sup> / <sub>8</sub>	2 <sup>3</sup> / <sub>8</sub>	1.9370	0.748	1/2
40 1 <sup>1</sup> / <sub>2</sub> 1 <sup>7</sup> / <sub>16</sub>	<b>UCPX08D1</b> <b>UCPX08-108D1</b> <b>UCPX08-109D1</b>	58.7	222	156	67	20	23	26	111	65	49.2	19	M16
		2 <sup>5</sup> / <sub>16</sub>	8 <sup>3</sup> / <sub>4</sub>	6 <sup>5</sup> / <sub>32</sub>	2 <sup>5</sup> / <sub>8</sub>	2 <sup>5</sup> / <sub>32</sub>	2 <sup>9</sup> / <sub>32</sub>	1 <sup>1</sup> / <sub>32</sub>	4 <sup>3</sup> / <sub>8</sub>	2 <sup>9</sup> / <sub>16</sub>	1.9370	0.748	5/8
45 1 <sup>5</sup> / <sub>8</sub> 1 <sup>11</sup> / <sub>16</sub> 1 <sup>3</sup> / <sub>4</sub> 1 <sup>13</sup> / <sub>16</sub>	<b>UCPX09D1</b> <b>UCPX09-110D1</b> <b>UCPX09-111D1</b> <b>UCPX09-112D1</b> <b>UCPX09-113D1</b>	58.7	222	156	67	20	23	26	116	65	51.6	19	M16
		2 <sup>5</sup> / <sub>16</sub>	8 <sup>3</sup> / <sub>4</sub>	6 <sup>5</sup> / <sub>32</sub>	2 <sup>5</sup> / <sub>8</sub>	2 <sup>5</sup> / <sub>32</sub>	2 <sup>9</sup> / <sub>32</sub>	1 <sup>1</sup> / <sub>32</sub>	4 <sup>9</sup> / <sub>16</sub>	2 <sup>9</sup> / <sub>16</sub>	2.0315	0.748	5/8
50 1 <sup>7</sup> / <sub>8</sub> 1 <sup>15</sup> / <sub>16</sub> 2	<b>UCPX10D1</b> <b>UCPX10-114D1</b> <b>UCPX10-115D1</b> <b>UCPX10-200D1</b>	63.5	241	171	73	20	23	27	126	70	55.6	22.2	M16
		2 <sup>1</sup> / <sub>2</sub>	9 <sup>1</sup> / <sub>2</sub>	6 <sup>23</sup> / <sub>32</sub>	2 <sup>7</sup> / <sub>8</sub>	2 <sup>5</sup> / <sub>32</sub>	2 <sup>9</sup> / <sub>32</sub>	1 <sup>1</sup> / <sub>16</sub>	4 <sup>31</sup> / <sub>32</sub>	2 <sup>3</sup> / <sub>4</sub>	2.1890	0.874	5/8

Note (1) These numbers indicate relubricatable type. If maintenance free type is needed, please order without suffix "D1".

Remarks Please refer to page A21 for size of grease fitting.

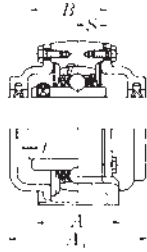
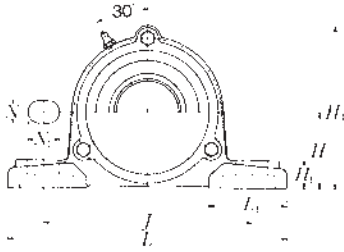

**Cast dust cover type**  
 Open end **C-UCP...D1**  
 Closed end **CM-UCP...D1**

Bearing number	Housing number	Unit number (1) cast dust cover type	Nominal dimensions			Mass of unit	
			mm inch			kg lb	
			t max.	H <sub>3</sub>	A <sub>5</sub>	UCP	C(CM)
UCX05D1	PX05D1	<b>C(CM)-UCPX05D1</b>	2	89	75	1.4	1.8
UCX05-013D1	PX05D1	<b>C(CM)-UCPX05-013D1</b>					
UCX05-014D1	PX05D1	<b>C(CM)-UCPX05-014D1</b>	5/64	3 1/2	2 15/16	3.1	4.0
UCX05-015D1	PX05D1	<b>C(CM)-UCPX05-015D1</b>					
UCX05-100D1	PX05D1	<b>C(CM)-UCPX05-100D1</b>					
UCX06D1	PX06D1	<b>C(CM)-UCPX06D1</b>	2	99	80	1.9	2.4
UCX06-101D1	PX06D1	<b>C(CM)-UCPX06-101D1</b>					
UCX06-102D1	PX06D1	<b>C(CM)-UCPX06-102D1</b>	5/64	3 29/32	3 3/32	4.2	5.3
UCX06-103D1	PX06D1	<b>C(CM)-UCPX06-103D1</b>					
UC207-104D1	PX06D1	<b>C(CM)-UCPX06-104D1</b>					
UCX07D1	PX07D1	<b>C(CM)-UCPX07D1</b>	3	110	90	2.4	3.3
UCX07-105D1	PX07D1	<b>C(CM)-UCPX07-105D1</b>					
UCX07-106D1	PX07D1	<b>C(CM)-UCPX07-106D1</b>	1/8	4 1/32	3 17/32	5.3	7.3
UCX07-107D1	PX07D1	<b>C(CM)-UCPX07-107D1</b>					
UCX08D1	PX08D1	<b>C(CM)-UCPX08D1</b>	3	118	95	2.9	3.8
UCX08-108D1	PX08D1	<b>C(CM)-UCPX08-108D1</b>	1/8	4 21/32	3 3/4	6.4	8.4
UCX08-109D1	PX08D1	<b>C(CM)-UCPX08-109D1</b>					
UCX09D1	PX09D1	<b>C(CM)-UCPX09D1</b>	3	120	100	3.2	4.2
UCX09-110D1	PX09D1	<b>C(CM)-UCPX09-110D1</b>					
UCX09-111D1	PX09D1	<b>C(CM)-UCPX09-111D1</b>	1/8	4 23/32	3 15/16	7.1	9.3
UCX09-112D1	PX09D1	<b>C(CM)-UCPX09-112D1</b>					
UC210-113D1	PX09D1	<b>C(CM)-UCPX09-113D1</b>					
UCX10D1	PX10D1	<b>C(CM)-UCPX10D1</b>	3	130	100	4.1	5.4
UCX10-114D1	PX10D1	<b>C(CM)-UCPX10-114D1</b>					
UCX10-115D1	PX10D1	<b>C(CM)-UCPX10-115D1</b>	1/8	5 1/8	3 15/16	9.0	12
UC211-200D1	PX10D1	<b>C(CM)-UCPX10-200D1</b>					



## Pillow block unit, cast housing Set screw type

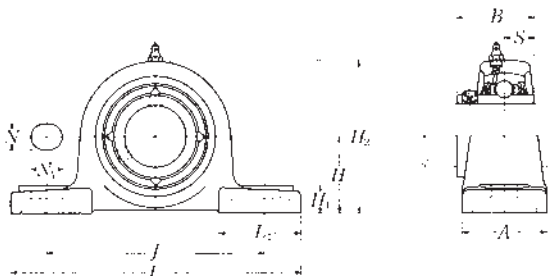

Shaft dia. mm inch	Unit number (1)	Nominal dimensions											Bolt size mm inch
		H	L	J	A	N	N <sub>1</sub>	H <sub>1</sub>	H <sub>2</sub>	L <sub>1</sub>	B	S	
55 2 1/16 2 1/8 2 3/16 2 1/4 2 5/16	<b>UCPX11D1</b> <b>UCPX11-201D1</b> <b>UCPX11-202D1</b> <b>UCPX11-203D1</b> <b>UCPX11-204D1</b> <b>UCPX11-205D1</b>	69.8 2 3/4	260 10 1/4	184 7 1/4	79 3 1/8	25 3 1/32	28 1 3/32	30 1 3/16	137 5 13/32	75 2 15/16	65.1 2.5630	25.4 1.000	M20 3/4
60 2 3/8 2 7/16	<b>UCPX12D1</b> <b>UCPX12-206D1</b> <b>UCPX12-207D1</b>	76.2 3	286 11 1/4	203 8	83 3 9/32	25 3 1/32	28 1 3/32	33 1 5/16	151 5 15/16	80 3 5/32	65.1 2.5630	25.4 1.000	M20 3/4
65 2 1/2 2 9/16	<b>UCPX13D1</b> <b>UCPX13-208D1</b> <b>UCPX13-209D1</b>	76.2 3	286 11 1/4	203 8	83 3 9/32	25 3 1/32	28 1 3/32	33 1 5/16	154 6 1/16	80 3 5/32	74.6 2.9370	30.2 1.189	M20 3/4
70 2 5/8 2 11/16 2 3/4	<b>UCPX14D1</b> <b>UCPX14-210D1</b> <b>UCPX14-211D1</b> <b>UCPX14-212D1</b>	88.9 3 1/2	330 13	229 9 1/32	89 3 1/2	27 1 1/16	30 1 3/16	35 1 3/8	170 6 11/16	95 3 3/4	77.8 3.0630	33.3 1.311	M22 7/8
75 2 13/16 2 7/8 2 5/8 3	<b>UCPX15D1</b> <b>UCPX15-213D1</b> <b>UCPX15-214D1</b> <b>UCPX15-215D1</b> <b>UCPX15-300D1</b>	88.9 3 1/2	330 13	229 9 1/32	89 3 1/2	27 1 1/16	30 1 3/16	35 1 3/8	175 6 7/8	95 3 3/4	82.6 3.2520	33.3 1.311	M22 7/8
80 3 1/16 3 1/8 3 3/16 3 1/4	<b>UCPX16D1</b> <b>UCPX16-301D1</b> <b>UCPX16-302D1</b> <b>UCPX16-303D1</b> <b>UCPX16-304D1</b>	101.6 4	381 15	283 11 5/32	102 4 1/32	27 1 1/16	30 1 3/16	40 1 9/16	194 7 5/8	110 4 11/32	85.7 3.3740	34.1 1.343	M22 7/8
85 3 5/16 3 3/8	<b>UCPX17D1</b> <b>UCPX17-305D1</b> <b>UCPX17-307D1</b>	101.6 4	381 15	283 11 5/32	102 4 1/32	27 1 1/16	30 1 3/16	40 1 9/16	200 7 7/8	110 4 11/32	96 3.7795	39.7 1.563	M22 7/8

Note (1) These numbers indicate relubricatable type. If maintenance free type is needed, please order without suffix "D1".

Remarks Please refer to page A21 for size of grease fitting.

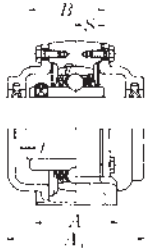
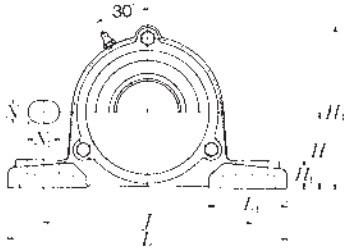

**Cast dust cover type**  
 Open end **C-UCP...D1**  
 Closed end **CM-UCP...D1**

Bearing number	Housing number	Unit number (*) cast dust cover type	Nominal dimensions			Mass of unit	
			mm inch			kg lb	
			t max.	H <sub>3</sub>	A <sub>3</sub>	UCP	C(CM)
UCX11D1	PX11D1	<b>C(CM)-UCPX11D1</b>	4	144	115	5.4	6.9
UCX11-201D1	PX11D1	<b>C(CM)-UCPX11-201D1</b>					
UCX11-202D1	PX11D1	<b>C(CM)-UCPX11-202D1</b>					
UCX11-203D1	PX11D1	<b>C(CM)-UCPX11-203D1</b>	5/32	5 <sup>21</sup> / <sub>32</sub>	4 <sup>17</sup> / <sub>32</sub>	12	15
UC212-204D1	PX11D1	<b>C(CM)-UCPX11-204D1</b>					
UC212-205D1	PX11D1	<b>C(CM)-UCPX11-205D1</b>					
UCX12D1	PX12D1	<b>C(CM)-UCPX12D1</b>	4	155	120	6.8	8.6
UCX12-206D1	PX12D1	<b>C(CM)-UCPX12-206D1</b>	5/32	6 <sup>3</sup> / <sub>32</sub>	4 <sup>25</sup> / <sub>32</sub>	15	19
UCX12-207D1	PX12D1	<b>C(CM)-UCPX12-207D1</b>					
UCX13D1	PX13D1	<b>C(CM)-UCPX13D1</b>	4	159	135	7.2	9.4
UCX13-208D1	PX13D1	<b>C(CM)-UCPX13-208D1</b>	5/32	6 <sup>1</sup> / <sub>4</sub>	5 <sup>5</sup> / <sub>16</sub>	16	21
UCX13-209D1	PX13D1	<b>C(CM)-UCPX13-209D1</b>					
UCX14D1	PX14D1	<b>C(CM)-UCPX14D1</b>	4	175	135	9.3	12
UCX14-210D1	PX14D1	<b>C(CM)-UCPX14-210D1</b>					
UCX14-211D1	PX14D1	<b>C(CM)-UCPX14-211D1</b>	5/32	6 <sup>7</sup> / <sub>8</sub>	5 <sup>5</sup> / <sub>16</sub>	21	26
UCX14-212D1	PX14D1	<b>C(CM)-UCPX14-212D1</b>					
UCX15D1	PX15D1	<b>C(CM)-UCPX15D1</b>	4	181	145	10	13
UCX15-213D1	PX15D1	<b>C(CM)-UCPX15-213D1</b>					
UCX15-214D1	PX15D1	<b>C(CM)-UCPX15-214D1</b>	5/32	7 <sup>1</sup> / <sub>8</sub>	5 <sup>23</sup> / <sub>32</sub>	22	29
UCX15-215D1	PX15D1	<b>C(CM)-UCPX15-215D1</b>					
UCX15-300D1	PX15D1	<b>C(CM)-UCPX15-300D1</b>					
UCX16D1	PX16D1	<b>C(CM)-UCPX16D1</b>	4	198	155	14	17
UCX16-301D1	PX16D1	<b>C(CM)-UCPX16-301D1</b>					
UCX16-302D1	PX16D1	<b>C(CM)-UCPX16-302D1</b>	5/32	7 <sup>25</sup> / <sub>32</sub>	6 <sup>3</sup> / <sub>32</sub>	31	37
UCX16-303D1	PX16D1	<b>C(CM)-UCPX16-303D1</b>					
UC217-304D1	PX16D1	<b>C(CM)-UCPX16-304D1</b>					
UCX17D1	PX17D1	<b>C(CM)-UCPX17D1</b>	5	204	165	15	19
UCX17-305D1	PX17D1	<b>C(CM)-UCPX17-305D1</b>	1 <sup>3</sup> / <sub>64</sub>	8 <sup>1</sup> / <sub>32</sub>	6 <sup>1</sup> / <sub>2</sub>	33	42
UCX17-307D1	PX17D1	<b>C(CM)-UCPX17-307D1</b>					

## Pillow block unit, cast housing Set screw type

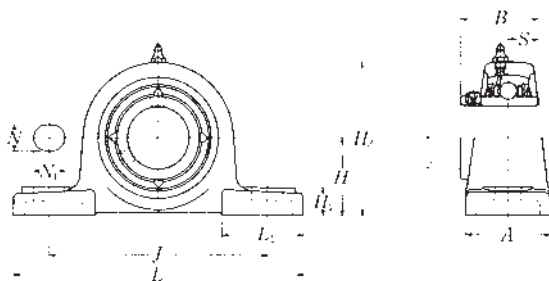

Shaft dia. mm inch	Unit number (1)	Nominal dimensions											Bolt size mm inch
		<i>H</i>	<i>L</i>	<i>J</i>	<i>A</i>	<i>N</i>	<i>N</i> <sub>1</sub>	<i>H</i> <sub>1</sub>	<i>H</i> <sub>2</sub>	<i>L</i> <sub>1</sub>	<i>B</i>	<i>S</i>	
90	<b>UCPX18D1</b>	101.6	381	283	111	27	30	40	206	110	104	42.9	M22
3 <sup>7</sup> / <sub>16</sub>	<b>UCPX18-307D1</b>	4	15	11 <sup>5</sup> / <sub>32</sub>	4 <sup>3</sup> / <sub>8</sub>	1 <sup>1</sup> / <sub>16</sub>	1 <sup>3</sup> / <sub>16</sub>	1 <sup>9</sup> / <sub>16</sub>	8 <sup>7</sup> / <sub>8</sub>	4 <sup>1</sup> / <sub>32</sub>	4.0945	1.689	<sup>7</sup> / <sub>8</sub>
3 <sup>1</sup> / <sub>2</sub>	<b>UCPX18-308D1</b>												
100	<b>UCPX20D1</b>	127	432	337	121	33	36	45	244	125	117.5	49.2	M27
3 <sup>13</sup> / <sub>16</sub>	<b>UCPX20-313D1</b>												
3 <sup>7</sup> / <sub>8</sub>	<b>UCPX20-314D1</b>	5	17	13 <sup>9</sup> / <sub>32</sub>	4 <sup>3</sup> / <sub>4</sub>	1 <sup>5</sup> / <sub>16</sub>	1 <sup>13</sup> / <sub>32</sub>	1 <sup>25</sup> / <sub>32</sub>	9 <sup>19</sup> / <sub>32</sub>	4 <sup>29</sup> / <sub>32</sub>	4.6260	1.937	1
3 <sup>15</sup> / <sub>16</sub>	<b>UCPX20-315D1</b>												
4	<b>UCPX20-400D1</b>												

Note (1) These numbers indicate relubricatable type. If maintenance free type is needed, please order without suffix "D1".

Remarks Please refer to page A21 for size of grease fitting.

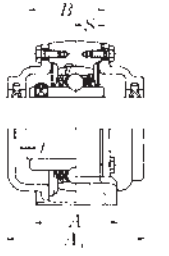
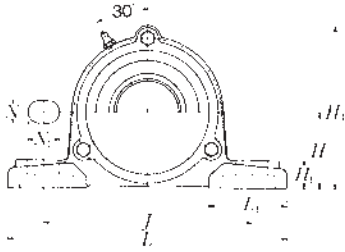

**Cast dust cover type**  
 Open end **C-UCP...D1**  
 Closed end **CM-UCP...D1**

Bearing number	Housing number	Unit number (*) cast dust cover type	Nominal dimensions			Mass of unit	
			mm inch			kg lb	
			t max.	H <sub>3</sub>	A <sub>3</sub>	UCP	C(CM)
UCX18D1	PX18D1	<b>C(CM)-UCPX18D1</b>	5	208	180	16	21
UCX18-307D1	PX18D1	<b>C(CM)-UCPX18-307D1</b>	13/64	8 3/16	7 3/32	35	46
UCX18-308D1	PX18D1	<b>C(CM)-UCPX18-308D1</b>					
UCX20D1	PX20D1	<b>C(CM)-UCPX20D1</b>	5	244	195	25	29
UCX20-313D1	PX20D1	<b>C(CM)-UCPX20-313D1</b>					
UCX20-314D1	PX20D1	<b>C(CM)-UCPX20-314D1</b>					
UCX20-315D1	PX20D1	<b>C(CM)-UCPX20-315D1</b>	13/64	9 19/32	7 11/16	55	64
UCX20-400D1	PX20D1	<b>C(CM)-UCPX20-400D1</b>					

## Pillow block unit, cast housing low center height Set screw type

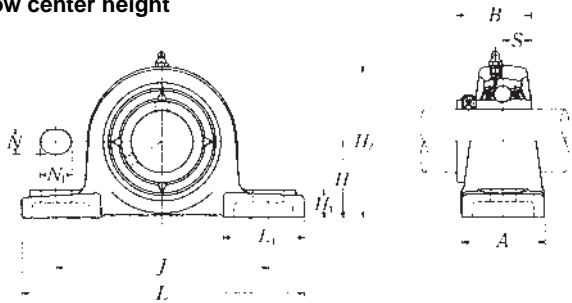

Shaft dia.  mm inch	Unit number <sup>(1)</sup> ( <sup>2</sup> )( <sup>3</sup> )	Nominal dimensions											Bolt size  mm inch
		mm inch											
		H	L	J	A	N	N <sub>1</sub>	H <sub>1</sub>	H <sub>2</sub>	L <sub>1</sub>	B	S	
20  3/4	UCPL204D1	31.75	127	95	38	13	16	14	64	42	31	12.7	M10
	UCPL204-012D1	1 1/4	5	3 3/4	1 1/2	1/2	5/8	9/16	2 17/32	1 21/32	1.2205	0.500	3/8
25  13/16 7/8 15/16 1	UCPL205D1	33.34	140	105	38	13	16	15	68	42	34.1	14.3	M10
	UCPL205-013D1												
	UCPL205-014D1												
	UCPL205-015D1	1 5/16	5 1/2	4 1/8	1 1/2	1/2	5/8	19/32	2 1/16	1 21/32	1.3425	0.563	3/8
	UCPL205-100D1												
30  1 1/16 1 1/8 1 1/16 1 1/4	UCPL206D1	39.69	165	121	48	17	20	17	80	54	38.1	15.9	M14
	UCPL206-101D1												
	UCPL206-102D1	1 9/16	6 1/2	4 3/4	1 7/8	2 1/32	25/32	2 1/32	3 5/32	2 1/8	1.5000	0.626	1/2
	UCPL206-103D1												
	UCPL206-104D1												
35  1 1/4 1 5/16 1 3/8 1 7/16	UCPL207D1	46.04	167	127	48	17	20	18	91	54	42.9	17.5	M14
	UCPL207-104D1												
	UCPL207-105D1	1 13/16	6 9/16	5	1 7/8	2 1/32	25/32	2 3/32	3 19/32	2 1/8	1.6890	0.689	1/2
	UCPL207-106D1												
	UCPL207-107D1												
45  1 5/8 1 11/16 1 3/4	UCPL209D1	52.39	190	146	54	17	20	20	104	60	49.2	19	M14
	UCPL209-110D1												
	UCPL209-111D1	2 1/16	7 15/32	5 3/4	2 1/8	2 1/32	25/32	25/32	4 3/32	2 3/8	1.9370	0.748	1/2
	UCPL209-112D1												
50  1 13/16 1 7/8 1 15/16 2	UCPL210D1	55.56	206	159	60	20	23	21	112	65	51.6	19	M16
	UCPL210-113D1												
	UCPL210-114D1	2 3/16	8 1/8	6 1/4	2 3/8	25/32	29/32	13/16	4 13/32	2 9/16	2.0315	0.748	5/8
	UCPL210-115D1												
	UCPL210-200D1												

Notes <sup>(1)</sup> These numbers indicate relubricatable type. If maintenance free type is needed, please order without suffix "D1".

<sup>(2)</sup> UCPL204 and UCPL205 has solid bases.

<sup>(3)</sup> UCPL208 has the same dimension as UCP208 shown in page B4.

Remarks Please refer to page A21 for size of grease fitting.

Bearing number	Housing number	Mass of unit
		kg lb
UC204D1	PL204D1	0.7
UC204-012D1	PL204D1	1.5
UC205D1	PL205D1	0.8
UC205-013D1	PL205D1	1.8
UC205-014D1	PL205D1	
UC205-015D1	PL205D1	
UC205-100D1	PL205D1	
UC206D1	PL206D1	1.3
UC206-101D1	PL206D1	2.9
UC206-102D1	PL206D1	
UC206-103D1	PL206D1	
UC206-104D1	PL206D1	
UC207D1	PL207D1	1.6
UC207-104D1	PL207D1	3.5
UC207-105D1	PL207D1	
UC207-106D1	PL207D1	
UC207-107D1	PL207D1	
UC209D1	PL209D1	2.2
UC209-110D1	PL209D1	4.9
UC209-111D1	PL209D1	
UC209-112D1	PL209D1	
UC210D1	PL210D1	2.8
UC210-113D1	PL210D1	6.2
UC210-114D1	PL210D1	
UC210-115D1	PL210D1	
UC210-200D1	PL210D1	

## Pillow block unit, cast housing low center height Set screw type

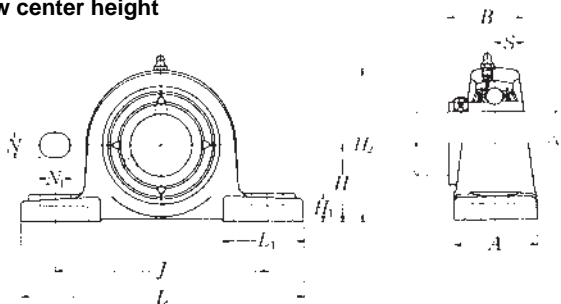

Shaft dia. mm inch	Unit number (*)	Nominal dimensions											Bolt size mm inch
		mm inch											
		H	L	J	A	N	N <sub>1</sub>	H <sub>1</sub>	H <sub>2</sub>	L <sub>1</sub>	B	S	
55	<b>UCPL211D1</b>	61.91	219	171	60	20	23	23	124	65	55.6	22.2	M16
2	<b>UCPL211-200D1</b>												
2 <sup>1</sup> / <sub>16</sub>	<b>UCPL211-201D1</b>	2 <sup>7</sup> / <sub>16</sub>	8 <sup>5</sup> / <sub>8</sub>	6 <sup>23</sup> / <sub>32</sub>	2 <sup>3</sup> / <sub>8</sub>	25 <sup>1</sup> / <sub>32</sub>	29 <sup>1</sup> / <sub>32</sub>	29 <sup>1</sup> / <sub>32</sub>	4 <sup>7</sup> / <sub>8</sub>	2 <sup>9</sup> / <sub>16</sub>	2.1890	0.874	5 <sup>1</sup> / <sub>8</sub>
2 <sup>1</sup> / <sub>8</sub>	<b>UCPL211-202D1</b>												
2 <sup>3</sup> / <sub>16</sub>	<b>UCPL211-203D1</b>												
60	<b>UCPL212D1</b>	68.26	241	184	70	20	23	25	136	70	65.1	25.4	M16
2 <sup>1</sup> / <sub>4</sub>	<b>UCPL212-204D1</b>												
2 <sup>5</sup> / <sub>16</sub>	<b>UCPL212-205D1</b>	2 <sup>11</sup> / <sub>16</sub>	9 <sup>1</sup> / <sub>2</sub>	7 <sup>1</sup> / <sub>4</sub>	2 <sup>3</sup> / <sub>4</sub>	25 <sup>1</sup> / <sub>32</sub>	29 <sup>1</sup> / <sub>32</sub>	3 <sup>1</sup> / <sub>32</sub>	5 <sup>11</sup> / <sub>32</sub>	2 <sup>3</sup> / <sub>4</sub>	2.5630	1.000	5 <sup>1</sup> / <sub>8</sub>
2 <sup>3</sup> / <sub>8</sub>	<b>UCPL212-206D1</b>												
2 <sup>1</sup> / <sub>2</sub>	<b>UCPL212-207D1</b>												

**Note (\*)** These numbers indicate relubricatable type. If maintenance free type is needed, please order without suffix "D1".

**Remarks** Please refer to page A21 for size of grease fitting.

Bearing number	Housing number	Mass of unit
		kg lb
UC211D1	PL211D1	3.4
UC211-200D1	PL211D1	7.5
UC211-201D1	PL211D1	
UC211-202D1	PL211D1	
UC211-203D1	PL211D1	
UC212D1	PL212D1	4.7
UC212-204D1	PL212D1	10
UC212-205D1	PL212D1	
UC212-206D1	PL212D1	
UC212-207D1	PL212D1	



## Pillow block unit, cast housing high center height Set screw type

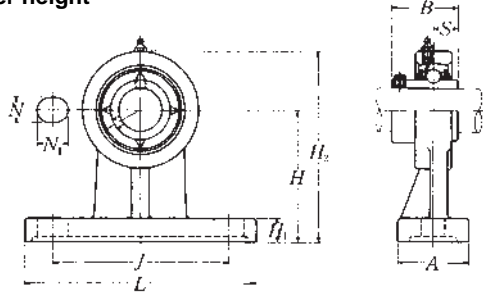

Shaft dia. mm inch	Unit number (1)	Nominal dimensions										Bolt size mm inch
		H	L	J	A	N	N <sub>1</sub>	H <sub>1</sub>	H <sub>2</sub>	B	S	
12 1/2	UCHP201D1	70	127	95	40	13	19	13	101	31	12.7	M10
	UCHP201-008D1	2 3/4	5	3 3/4	1 9/16	1/2	3/4	1/2	3 31/32	1.2205	0.500	3/8
15 9/16 5/8	UCHP202D1	70	127	95	40	13	19	13	101	31	12.7	M10
	UCHP202-009D1 UCHP202-010D1	2 3/4	5	3 3/4	1 9/16	1/2	3/4	1/2	3 31/32	1.2205	0.500	3/8
17 1 1/16	UCHP203D1	70	127	95	40	13	19	13	101	31	12.7	M10
	UCHP203-011D1	2 3/4	5	3 3/4	1 9/16	1/2	3/4	1/2	3 31/32	1.2205	0.500	3/8
20 3/4	UCHP204D1	70	127	95	40	13	19	13	101	31	12.7	M10
	UCHP204-012D1	2 3/4	5	3 3/4	1 9/16	1/2	3/4	1/2	3 31/32	1.2205	0.500	3/8
25 1 3/16 7/8 15/16 1	UCHP205D1	80	142	105	50	13	19	13	114	34.1	14.3	M10
	UCHP205-013D1											
	UCHP205-014D1	3 5/32	5 19/32	4 1/8	1 31/32	1/2	3/4	1/2	4 1/2	1.3425	0.563	3/8
	UCHP205-015D1 UCHP205-100D1											
30 1 1/16 1 1/8 1 3/16 1 1/4	UCHP206D1	90	165	120	50	17	21	16	130	38.1	15.9	M14
	UCHP206-101D1											
	UCHP206-102D1	3 35/64	6 1/2	4 23/32	1 31/32	2 1/32	1 5/16	5/8	5 1/8	1.5000	0.626	1/2
	UCHP206-103D1 UCHP206-104D1											
35 1 1/4 1 5/16 1 3/8 1 1/16	UCHP207D1	95	166	127	60	17	21	18	140	42.9	17.5	M14
	UCHP207-104D1											
	UCHP207-105D1	3 47/64	6 17/32	5	2 3/8	2 1/32	1 3/16	23/32	5 1/2	1.6890	0.689	1/2
	UCHP207-106D1 UCHP207-107D1											
40 1 1/2 1 9/16	UCHP208D1	100	184	136	70	17	21	20	150	49.2	19	M14
	UCHP208-108D1 UCHP208-109D1	3 15/16	7 1/4	5 11/32	2 3/4	2 1/32	1 3/16	25/32	5 29/32	1.9370	0.748	1/2

Note (1) These numbers indicate relubricatable type. If maintenance free type is needed, please order without suffix "D1".

Remarks Please refer to page A21 for size of grease fitting.

Bearing number	Housing number	Mass of unit
		kg lb
UC201D1	HP204D1	0.9
UC201-008D1	HP204D1	2.0
UC202D1	HP204D1	0.9
UC202-009D1	HP204D1	2.0
UC202-010D1	HP204D1	
UC203D1	HP204D1	0.9
UC203-011D1	HP204D1	2.0
UC204D1	HP204D1	0.9
UC204-012D1	HP204D1	2.0
UC205D1	HP205D1	1.2
UC205-013D1	HP205D1	
UC205-014D1	HP205D1	2.6
UC205-015D1	HP205D1	
UC205-100D1	HP205D1	
UC206D1	HP206D1	1.8
UC206-101D1	HP206D1	
UC206-102D1	HP206D1	4.0
UC206-103D1	HP206D1	
UC206-104D1	HP206D1	
UC207D1	HP207D1	2.3
UC207-104D1	HP207D1	
UC207-105D1	HP207D1	5.1
UC207-106D1	HP207D1	
UC207-107D1	HP207D1	
UC208D1	HP208D1	3.2
UC208-108D1	HP208D1	7.1
UC208-109D1	HP208D1	

## Pillow block unit, cast housing high center height Set screw type

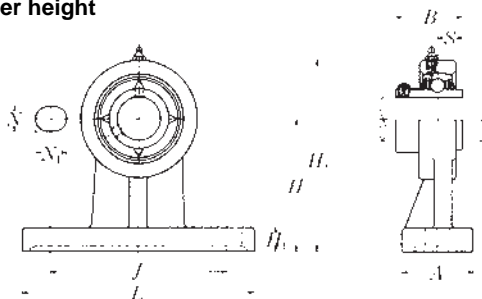

Shaft dia. mm inch	Unit number (*)	Nominal dimensions										Bolt size mm inch
		<i>H</i>	<i>L</i>	<i>J</i>	<i>A</i>	<i>N</i>	<i>N</i> <sub>1</sub>	<i>H</i> <sub>1</sub>	<i>H</i> <sub>2</sub>	<i>B</i>	<i>S</i>	
45	<b>UCHP209D1</b>	105	190	146	70	17	22	20	158	49.2	19	M14
1 5/8	<b>UCHP209-110D1</b>											
1 11/16	<b>UCHP209-111D1</b>	4 9/64	7 15/32	5 3/4	2 3/4	2 1/32	7/8	25/32	6 7/32	1.9370	0.748	1/2
1 3/4	<b>UCHP209-112D1</b>											
50	<b>UCHP210D1</b>	110	206	159	70	20	22	22	165	51.6	19	M16
1 13/16	<b>UCHP210-113D1</b>											
1 7/8	<b>UCHP210-114D1</b>	4 21/64	8 1/8	6 1/4	2 3/4	25/32	7/8	7/8	6 1/2	2.0315	0.748	5/8
1 15/16	<b>UCHP210-115D1</b>											
2	<b>UCHP210-200D1</b>											

**Note (\*)** These numbers indicate relubricatable type. If maintenance free type is needed, please order without suffix "D1".

**Remarks** Please refer to page A21 for size of grease fitting.

Bearing number	Housing number	Mass of unit
		kg lb
UC209D1	HP209D1	3.5
UC209-110D1	HP209D1	7.7
UC209-111D1	HP209D1	
UC209-112D1	HP209D1	
UC210D1	HP210D1	3.9
UC210-113D1	HP210D1	8.6
UC210-114D1	HP210D1	
UC210-115D1	HP210D1	
UC210-200D1	HP210D1	

## Narrow pillow block unit, cast housing Set screw type

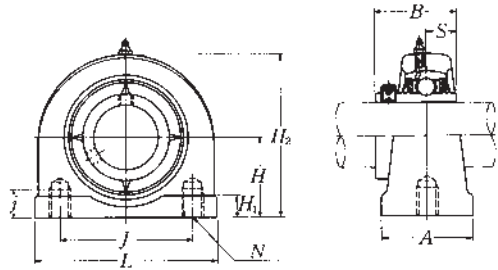

Shaft dia.  mm inch	Unit number <sup>(1)</sup>	Nominal dimensions									
		mm inch									
		H	L	J	A	j	H <sub>1</sub>	H <sub>2</sub>	B	S	N
12 ½	UCUP201D1	30.2	76	52	38	13	11	62	31	12.7	M10×1.5
	UCUP201-008D1	1 <sup>3</sup> / <sub>16</sub>	3	2 <sup>1</sup> / <sub>16</sub>	1½	½	7/16	2 <sup>7</sup> / <sub>16</sub>	1.2205	0.500	
15 9/16 5/8	UCUP202D1	30.2	76	52	38	13	11	62	31	12.7	M10×1.5
	UCUP202-009D1 UCUP202-010D1	1 <sup>3</sup> / <sub>16</sub>	3	2 <sup>1</sup> / <sub>16</sub>	1½	½	7/16	2 <sup>7</sup> / <sub>16</sub>	1.2205	0.500	
17 11/16	UCUP203D1	30.2	76	52	38	13	11	62	31	12.7	M10×1.5
	UCUP203-011D1	1 <sup>3</sup> / <sub>16</sub>	3	2 <sup>1</sup> / <sub>16</sub>	1½	½	7/16	2 <sup>7</sup> / <sub>16</sub>	1.2205	0.500	
20 3/4	UCUP204D1	30.2	76	52	38	13	11	62	31	12.7	M10×1.5
	UCUP204-012D1	1 <sup>3</sup> / <sub>16</sub>	3	2 <sup>1</sup> / <sub>16</sub>	1½	½	7/16	2 <sup>7</sup> / <sub>16</sub>	1.2205	0.500	
25 13/16 7/8 15/16 1	UCUP205D1	36.5	84	56	38	15	12	72	34.1	14.3	M10×1.5
	UCUP205-013D1										
	UCUP205-014D1	1 <sup>7</sup> / <sub>16</sub>	3 <sup>5</sup> / <sub>16</sub>	2 <sup>7</sup> / <sub>32</sub>	1½	1 <sup>9</sup> / <sub>32</sub>	1 <sup>5</sup> / <sub>32</sub>	2 <sup>27</sup> / <sub>32</sub>	1.3425	0.563	
	UCUP205-015D1 UCUP205-100D1										
30 1 1/16 1 1/8 1 1/16 1 1/4	UCUP206D1	42.9	94	66	48	18	12	84	38.1	15.9	M14×2
	UCUP206-101D1										
	UCUP206-102D1	1 <sup>11</sup> / <sub>16</sub>	3 <sup>11</sup> / <sub>16</sub>	2 <sup>19</sup> / <sub>32</sub>	1 <sup>7</sup> / <sub>8</sub>	2 <sup>3</sup> / <sub>32</sub>	1 <sup>5</sup> / <sub>32</sub>	3 <sup>5</sup> / <sub>16</sub>	1.5000	0.629	
	UCUP206-103D1 UCUP206-104D1										
35 1 1/4 1 5/16 1 3/8 1 1/16	UCUP207D1	47.6	110	80	48	20	13	95	42.9	17.5	M14×2
	UCUP207-104D1										
	UCUP207-105D1	1 <sup>7</sup> / <sub>8</sub>	4 <sup>11</sup> / <sub>32</sub>	3 <sup>5</sup> / <sub>32</sub>	1 <sup>7</sup> / <sub>8</sub>	2 <sup>5</sup> / <sub>32</sub>	½	3 <sup>3</sup> / <sub>4</sub>	1.6890	0.689	
	UCUP207-106D1 UCUP207-107D1										
40 1 1/2 1 9/16	UCUP208D1	49.2	116	84	54	20	13	100	49.2	19	M14×2
	UCUP208-108D1										
	UCUP208-109D1	1 <sup>15</sup> / <sub>16</sub>	4 <sup>9</sup> / <sub>16</sub>	3 <sup>5</sup> / <sub>16</sub>	2 <sup>7</sup> / <sub>8</sub>	2 <sup>5</sup> / <sub>32</sub>	½	3 <sup>15</sup> / <sub>16</sub>	1.9370	0.748	

Note <sup>(1)</sup> These numbers indicate relubricatable type. If maintenance free type is needed, please order without suffix "D1".

Remarks Please refer to page A21 for size of grease fitting.

Bearing number	Housing number	Mass of unit
		kg lb
UC201D1	UP204D1	0.6
UC201-008D1	UP204D1	1.3
UC202D1	UP204D1	0.6
UC202-009D1	UP204D1	1.3
UC202-010D1	UP204D1	
UC203D1	UP204D1	0.6
UC203-011D1	UP204D1	1.3
UC204D1	UP204D1	0.6
UC204-012D1	UP204D1	1.3
UC205D1	UP205D1	0.7
UC205-013D1	UP205D1	
UC205-014D1	UP205D1	1.5
UC205-015D1	UP205D1	
UC205-100D1	UP205D1	
UC206D1	UP206D1	1.1
UC206-101D1	UP206D1	
UC206-102D1	UP206D1	2.4
UC206-103D1	UP206D1	
UC206-104D1	UP206D1	
UC207D1	UP207D1	1.6
UC207-104D1	UP207D1	
UC207-105D1	UP207D1	3.5
UC207-106D1	UP207D1	
UC207-107D1	UP207D1	
UC208D1	UP208D1	1.8
UC208-108D1	UP208D1	4.0
UC208-109D1	UP208D1	

# UCUP2

## Narrow pillow block unit, cast housing Set screw type

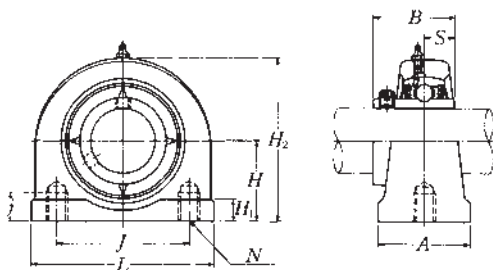

Shaft dia. mm inch	Unit number <sup>(1)</sup>	Nominal dimensions									
		mm inch									
		<i>H</i>	<i>L</i>	<i>J</i>	<i>A</i>	<i>j</i>	<i>H</i> <sub>1</sub>	<i>H</i> <sub>2</sub>	<i>B</i>	<i>S</i>	<i>N</i>
45	<b>UCUP209D1</b>	54.2	120	90	54	25	13	108	49.2	19	M14×2
1 5/8	<b>UCUP209-110D1</b>										
1 1/8	<b>UCUP209-111D1</b>	2 9/64	4 23/32	3 17/32	2 1/8	3 1/32	1/2	4 1/4	1.9370	0.748	
1 3/4	<b>UCUP209-112D1</b>										
50	<b>UCUP210D1</b>	57.2	130	94	60	25	14	116	51.6	19	M16×2
1 13/16	<b>UCUP210-113D1</b>										
1 7/8	<b>UCUP210-114D1</b>										
1 15/16	<b>UCUP210-115D1</b>	2 1/4	5 1/8	3 11/16	2 3/8	3 1/32	9/16	4 9/16	2.0315	0.748	
2	<b>UCUP210-200D1</b>										

**Note** <sup>(1)</sup> These numbers indicate relubricatable type. If maintenance free type is needed, please order without suffix "D1".

**Remarks** Please refer to page A21 for size of grease fitting.

Bearing number	Housing number	Mass of unit
		kg lb
UC209D1	UP209D1	2.1
UC209-110D1	UP209D1	4.6
UC209-111D1	UP209D1	
UC209-112D1	UP209D1	
UC210D1	UP210D1	2.6
UC210-113D1	UP210D1	5.7
UC210-114D1	UP210D1	
UC210-115D1	UP210D1	
UC210-200D1	UP210D1	



## Pillow block unit, cast housing low center height Set screw type

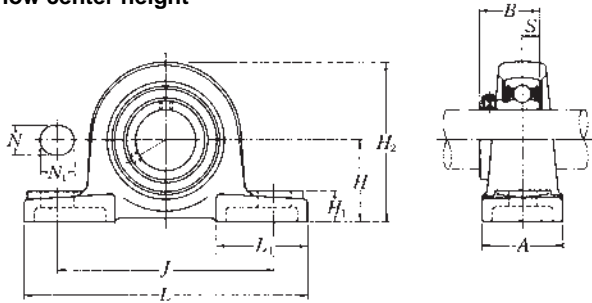

Shaft dia. mm inch	Unit number <sup>(1)</sup> ( <sup>2</sup> )( <sup>3</sup> )	Nominal dimensions											Bolt size mm inch
		mm inch											
		H	L	J	A	N	N <sub>1</sub>	H <sub>1</sub>	H <sub>2</sub>	L <sub>1</sub>	B	S	
12 ½	ASPL201	26.99	121	89	35	11	14	13	54	40	22	6	M10 ⅜
	ASPL201-008	1 ⅙	4 ¾	3 ½	1 ⅜	⅞	⅞	½	2 ⅙	1 ⅙	0.8661	0.236	
15 ⅝ ⅞	ASPL202	26.99	121	89	35	11	14	13	54	40	22	6	M10 ⅜
	ASPL202-009 ASPL202-010	1 ⅙	4 ¾	3 ½	1 ⅜	⅞	⅞	½	2 ⅙	1 ⅙	0.8661	0.236	
17 ⅞	ASPL203	26.99	121	89	35	11	14	13	54	40	22	6	M10 ⅜
	ASPL203-011	1 ⅙	4 ¾	3 ½	1 ⅜	⅞	⅞	½	2 ⅙	1 ⅙	0.8661	0.236	
20 ¾	ASPL204	31.75	127	95	38	13	16	14	64	42	25	7	M10 ⅜
	ASPL204-012	1 ¼	5	3 ¾	1 ½	½	⅝	⅞	2 ⅞	1 ⅞	0.9843	0.276	
25 1 ⅙ ⅞ 1 ⅙ 1	ASPL205	33.34	140	105	38	13	16	15	68	42	27	7.5	M10 ⅜
	ASPL205-013												
	ASPL205-014	1 ⅝	5 ½	4 ⅙	1 ½	½	⅝	1 ⅞	2 ⅞	1 ⅞	1.0630	0.295	
	ASPL205-015 ASPL205-100												
30 1 ⅙ 1 ⅙ 1 ⅙ 1 ¼	ASPL206	39.69	165	121	48	17	20	17	80	54	29	8	M14
	ASPL206-101												
	ASPL206-102	1 ⅞	6 ½	4 ¾	1 ⅞	⅞	⅞	⅞	3 ⅞	2 ⅙	1.1417	0.315	
	ASPL206-103 ASPL206-104												
35 1 ¼ 1 ⅙ 1 ⅙ 1 ⅙	ASPL207	46.04	167	127	48	17	20	18	91	54	34	8.5	M14
	ASPL207-104												
	ASPL207-105	1 ⅞	6 ⅞	5	1 ⅞	⅞	⅞	⅞	3 ⅞	2 ⅙	1.3386	0.335	
	ASPL207-106 ASPL207-107												
40 1 ½ 1 ⅙	ASP208	49.2	184	137	54	17	20	18	98	52	38	9	M14
	ASP208-108 ASP208-109	1 ⅞	7 ¼	5 ⅞	2 ⅙	⅞	⅞	⅞	3 ⅞	2 ⅙	1.4961	0.354	

- Notes (1) ASPL201 to ASPL205 has solid bases.  
 (2) If relubricatable type is needed, please order with suffix "D1".  
 (3) ASPL208 has the same dimension as ASP208.

Bearing number (°)	Housing number (°)	Mass of unit
		kg lb
AS201	PL201	0.5
AS201-008	PL201	1.1
AS202	PL201	0.5
AS202-009	PL201	1.1
AS202-010	PL201	
AS203	PL201	0.5
AS203-011	PL201	1.1
AS204	PL204	0.7
AS204-012	PL204	1.5
AS205	PL205	0.8
AS205-013	PL205	
AS205-014	PL205	1.8
AS205-015	PL205	
AS205-100	PL205	
AS206	PL206	1.2
AS206-101	PL206	
AS206-102	PL206	2.6
AS206-103	PL206	
AS206-104	PL206	
AS207	PL207	1.5
AS207-104	PL207	
AS207-105	PL207	3.3
AS207-106	PL207	
AS207-107	PL207	
AS208	P208	1.8
AS208-108	P208	4.0
AS208-109	P208	

# ASPL2

## Pillow block unit, cast housing low center height Set screw type

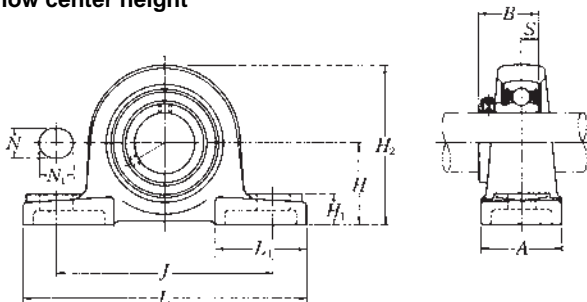

Shaft dia.	Unit number (1)	Nominal dimensions											Bolt size
		mm inch											
mm inch		H	L	J	A	N	N <sub>1</sub>	H <sub>1</sub>	H <sub>2</sub>	L <sub>1</sub>	B	S	mm inch
45 1 5/8	<b>ASPL209</b>	52.39	190	146	54	17	20	20	104	60	40	9.5	M14
1 1/8	<b>ASPL209-110</b>	2 3/16	7 15/32	5 3/4	2 1/8	2 1/32	25/32	25/32	4 3/32	2 3/8	1.578	0.374	1/2
1 3/4	<b>ASPL209-112</b>												
50 1 13/16	<b>ASPL210</b>	55.56	206	159	60	20	23	21	112	65	42	10	M16
1 7/8	<b>ASPL210-113</b>												
1 15/16	<b>ASPL210-114</b>	2 3/16	8 1/8	6 1/4	2 3/8	25/32	29/32	13/16	4 13/32	2 7/16	1.635	0.394	5/8
2	<b>ASPL210-200</b>												

Note (1) If relubricatable type is needed, please order with suffix "D1".

Bearing number (1)	Housing number (1)	Mass of unit
		kg lb
AS209	PL209	2.0
AS209-110	PL209	4.4
AS209-111	PL209	
AS209-112	PL209	
AS210	PL210	2.6
AS210-113	PL210	5.7
AS210-114	PL210	
AS210-115	PL210	
AS210-200	PL210	

## Pillow block unit, pressed steel housing Set screw type

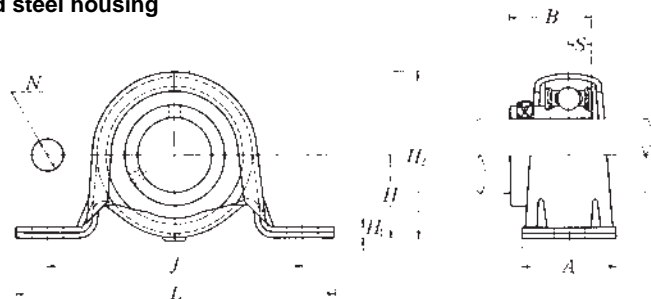

Shaft dia.  mm inch	Unit number	Nominal dimensions										Bolt size  mm inch
		mm inch										
		<i>H</i>	<i>L</i>	<i>J</i>	<i>A</i>	<i>N</i>	<i>H</i> <sub>1</sub>	<i>H</i> <sub>2</sub>	<i>B</i>	<i>S</i>		
12 1/2	<b>ASPP201</b> <b>ASPP201-008</b>	22.2 7/8	86 3 3/8	68 2 11/16	25 31/32	9.5 3/8	3.2 0.126	43.8 1 23/32	22 0.8661	6 0.236	M8 5/16	
15 9/16 5/8	<b>ASPP202</b> <b>ASPP202-009</b> <b>ASPP202-010</b>	22.2 7/8	86 3 3/8	68 2 11/16	25 31/32	9.5 3/8	3.2 0.126	43.8 1 23/32	22 0.8661	6 0.236	M8 5/16	
17 1 1/16	<b>ASPP203</b> <b>ASPP203-011</b>	22.2 7/8	86 3 3/8	68 2 11/16	25 31/32	9.5 3/8	3.2 0.126	43.8 1 23/32	22 0.8661	6 0.236	M8 5/16	
20 3/4	<b>ASPP204</b> <b>ASPP204-012</b>	25.4 1	98 3 27/32	76 3	32 1 1/4	9.5 3/8	3.2 0.126	50.5 2	25 0.9843	7 0.276	M8 5/16	
25 13/16 7/8 15/16 1	<b>ASPP205</b> <b>ASPP205-013</b> <b>ASPP205-014</b> <b>ASPP205-015</b> <b>ASPP205-100</b>	28.6 1 1/8	108 4 1/4	86 3 3/8	32 1 1/4	11.5 29/64	4 0.157	56.6 2 7/32	27 1.0630	7.5 0.295	M10 3/8	
30 1 1/16 1 1/8 1 3/16 1 1/4	<b>ASPP206</b> <b>ASPP206-101</b> <b>ASPP206-102</b> <b>ASPP206-103</b> <b>ASPP206-104</b>	33.3 1 5/16	117 4 19/32	95 3 3/4	38 1 1/2	11.5 29/64	4 0.157	66.3 2 5/8	29 1.1417	8 0.315	M10 3/8	
35 1 1/4 1 5/16 1 3/8 1 1/16	<b>ASPP207</b> <b>ASPP207-104</b> <b>ASPP207-105</b> <b>ASPP207-106</b> <b>ASPP207-107</b>	39.7 1 9/16	129 5 3/32	106 4 3/16	42 1 21/32	11.5 29/64	4.6 0.181	78 3 1/16	34 1.3386	8.5 0.335	M10 3/8	

Note (1) The permissible load only applies in applications where the load is stable and the speed is 2400 min<sup>-1</sup> or less.  
The mounting surface should be flat.

<b>Max. load (1)</b>		<b>Bearing number</b>	<b>Housing number</b>	<b>Mass of unit</b>	
<b>recommended</b>				<b>kg</b>	<b>lb</b>
<b>N lbf</b>					
radial	axial				
2 000	800	AS201	PP203	0.2	
440	160	AS201-008	PP203	0.4	
2 000	800	AS202	PP203	0.2	
440	160	AS202-009	PP203	0.4	
		AS202-010	PP203		
2 000	800	AS203	PP203	0.1	
440	160	AS203-011	PP203	0.2	
2 500	1 000	AS204	PP204	0.2	
550	200	AS204-012	PP204	0.4	
3 500	1 400	AS205	PP205	0.3	
		AS205-013	PP205		
770	280	AS205-014	PP205	0.7	
		AS205-015	PP205		
		AS205-100	PP205		
4 000	1 600	AS206	PP206	0.4	
		AS206-101	PP206		
880	320	AS206-102	PP206	0.9	
		AS206-103	PP206		
		AS206-104	PP206		
4 500	1 800	AS207	PP207	0.6	
		AS207-104	PP207		
990	360	AS207-105	PP207	1.3	
		AS207-106	PP207		
		AS207-107	PP207		

## Pillow block unit, pressed steel housing with rubber ring Set screw type

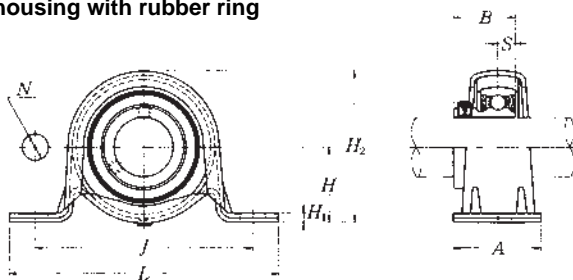

Shaft dia. mm inch	Unit number	Nominal dimensions									Bolt size mm inch
		mm inch									
		<i>H</i>	<i>L</i>	<i>J</i>	<i>A</i>	<i>N</i>	<i>H</i> <sub>1</sub>	<i>H</i> <sub>2</sub>	<i>B</i>	<i>S</i>	
12 ½	ASRPP201	25.4	98	76	32	9.5	3.2	50.5	22	6	M8
	ASRPP201-008	1	3 <sup>27</sup> / <sub>32</sub>	3	1¼	⅜	0.126	2	0.8661	0.236	⅝
15 9/16 5/8	ASRPP202	25.4	98	76	32	9.5	3.2	50.5	22	6	M8
	ASRPP202-009 ASRPP202-010	1	3 <sup>27</sup> / <sub>32</sub>	3	1¼	⅜	0.126	2	0.8661	0.236	⅝
17 11/16	ASRPP203	25.4	98	76	32	9.5	3.2	50.5	22	6	M8
	ASRPP203-011	1	3 <sup>27</sup> / <sub>32</sub>	3	1¼	⅜	0.126	2	0.8661	0.236	⅝
20 ¾	ASRPP204	28.6	108	86	32	11.5	4	56.6	25	7	M10
	ASRPP204-012	1⅛	4¼	3⅜	1¼	29/64	0.157	2 <sup>7</sup> / <sub>32</sub>	0.9843	0.276	⅜
25 13/16 7/8 15/16 1	ASRPP205	33.3	117	95	38	11.5	4	66.3	27	7.5	M10
	ASRPP205-013										
	ASRPP205-014	1 <sup>5</sup> / <sub>16</sub>	4 <sup>19</sup> / <sub>32</sub>	3¾	1½	29/64	0.157	2 <sup>5</sup> / <sub>8</sub>	1.0630	0.295	⅜
	ASRPP205-015 ASRPP205-100										
30 1 1/16 1 1/8 1 3/16 1 1/4	ASRPP206	39.7	129	106	42	11.5	4.6	78	29	8	M10
	ASRPP206-101										
	ASRPP206-102	1 <sup>9</sup> / <sub>16</sub>	5 <sup>3</sup> / <sub>32</sub>	4 <sup>3</sup> / <sub>16</sub>	1 <sup>21</sup> / <sub>32</sub>	29/64	0.181	3 <sup>1</sup> / <sub>16</sub>	1.1417	0.315	⅜
	ASRPP206-103 ASRPP206-104										

**Note** (1) The permissible load only applies in applications where the load is stable and the speed is 2400 min<sup>-1</sup> or less. The mounting surface should be flat.

**Remarks** When an anti-vibration rubber ring is used, the self alignment capability will be reduce.

Max. load (1) recommended		Bearing number	Housing number		Mass of unit  kg lb
			rubber ring	steel	
N lbf					
radial	axial				
1 000	200	AS201	R201	PP204	0.2
220	40	AS201-008	R201	PP204	0.4
1 000	200	AS202	R201	PP204	0.2
220	40	AS202-009	R201	PP204	0.4
		AS202-010	R201	PP204	
1 000	200	AS203	R201	PP204	0.2
220	40	AS203-011	R201	PP204	0.4
1 150	200	AS204	R204	PP205	0.3
250	40	AS204-012	R204	PP205	0.7
1 300	200	AS205	R205	PP206	0.4
		AS205-013	R205	PP206	0.9
280	40	AS205-014	R205	PP206	
		AS205-015	R205	PP206	
		AS205-100	R205	PP206	
1 500	200	AS206	R206	PP207	0.5
		AS206-101	R206	PP207	1.1
330	40	AS206-102	R206	PP207	
		AS206-103	R206	PP207	
		AS206-104	R206	PP207	



## Square flanged unit, cast housing Set screw type

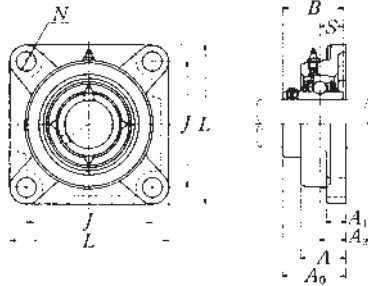

Shaft dia. mm inch	Unit number (*)	Nominal dimensions										Bolt size mm inch	Bearing number
		mm inch											
		L	J	A <sub>2</sub>	A <sub>1</sub>	A	N	A <sub>0</sub>	B	S			
12 1/2	UCF201D1	86	64	15	11	25.5	12	33.3	31	12.7	M10	UC201D1	
	UCF201-008D1	3 3/8	2 33/64	19/32	7/16	1	15/32	1 5/16	1.2205	0.500	3/8	UC201-008D1	
15 9/16 5/8	UCF202D1	86	64	15	11	25.5	12	33.3	31	12.7	M10	UC202D1	
	UCF202-009D1 UCF202-010D1	3 3/8	2 33/64	19/32	7/16	1	15/32	1 5/16	1.2205	0.500	3/8	UC202-009D1 UC202-010D1	
17 1 1/16	UCF203D1	86	64	15	11	25.5	12	33.3	31	12.7	M10	UC203D1	
	UCF203-011D1	3 3/8	2 33/64	19/32	7/16	1	15/32	1 5/16	1.2205	0.500	3/8	UC203-011D1	
20 3/4	UCF204D1	86	64	15	11	25.5	12	33.3	31	12.7	M10	UC204D1	
	UCF204-012D1	3 3/8	2 33/64	19/32	7/16	1	15/32	1 5/16	1.2205	0.500	3/8	UC204-012D1	
25 1 3/16 7/8 15/16 1	UCF205D1	95	70	16	13	27	12	35.8	34.1	14.3	M10	UC205D1	
	UCF205-013D1											UC205-013D1	
	UCF205-014D1	3 3/4	2 3/4	5/8	1/2	1 1/16	15/32	1 13/32	1.3425	0.563	3/8	UC205-014D1	
	UCF205-015D1 UCF205-100D1											UC205-015D1 UC205-100D1	
30 1 1/16 1 1/8 1 3/16 1 1/4	UCF206D1	108	83	18	13	31	12	40.2	38.1	15.9	M10	UC206D1	
	UCF206-101D1											UC206-101D1	
	UCF206-102D1	4 1/4	3 17/64	45/64	1/2	1 7/32	15/32	1 37/64	1.5000	0.626	3/8	UC206-102D1	
	UCF206-103D1 UCF206-104D1											UC206-103D1 UC206-104D1	
35 1 1/4 1 5/16 1 3/8 1 1/2	UCF207D1	117	92	19	15	34	14	44.4	42.9	17.5	M12	UC207D1	
	UCF207-104D1											UC207-104D1	
	UCF207-105D1	4 19/32	3 5/8	3/4	19/32	1 11/32	35/64	1 3/4	1.6890	0.689	7/16	UC207-105D1	
	UCF207-106D1 UCF207-107D1											UC207-106D1 UC207-107D1	
40 1 1/2 1 9/16	UCF208D1	130	102	21	15	36	16	51.2	49.2	19	M14	UC208D1	
	UCF208-108D1 UCF208-109D1	5 1/8	4 1/64	53/64	19/32	1 13/32	5/8	2 1/64	1.9370	0.748	1/2	UC208-108D1 UC208-109D1	
45 1 5/8 1 11/16 1 3/4	UCF209D1	137	105	22	16	38	16	52.2	49.2	19	M14	UC209D1	
	UCF209-110D1											UC209-110D1	
	UCF209-111D1 UCF209-112D1	5 13/32	4 9/64	55/64	5/8	1 1/2	5/8	2 1/16	1.9370	0.748	1/2	UC209-111D1 UC209-112D1	

Note (\*) These numbers indicate relubricatable type. If maintenance free type is needed, please order without suffix "D1".

Remarks Please refer to page A21 for size of grease fitting.

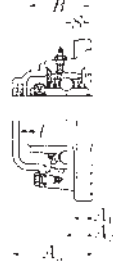
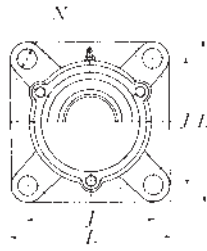
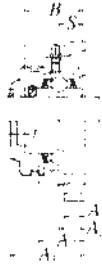
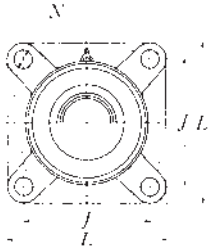

**Pressed steel dust cover type**

Open end **Z-UCF...D1**  
 Closed end **ZM-UCF...D1**

**Cast dust cover type**

Open end **C-UCF...D1**  
 Closed end **CM-UCF...D1**

Housing number	Unit number (*) pressed steel dust cover type	Unit number (*) cast dust cover type	Nominal dimensions			Mass of unit		
			mm inch			kg lb		
			t max.	A <sub>4</sub>	A <sub>5</sub>	UCF	Z(ZM)	C(CM)
F204D1 F204D1	<b>Z(ZM)-UCF201D1</b> <b>Z(ZM)-UCF201-008D1</b>	<b>C(CM)-UCF201D1</b> <b>C(CM)-UCF201-008D1</b>	2 5/64	38 1 1/2	46 1 13/16	0.6 1.3	0.6 1.3	0.8 1.8
F204D1 F204D1 F204D1	<b>Z(ZM)-UCF202D1</b> <b>Z(ZM)-UCF202-009D1</b> <b>Z(ZM)-UCF202-010D1</b>	<b>C(CM)-UCF202D1</b> <b>C(CM)-UCF202-009D1</b> <b>C(CM)-UCF202-010D1</b>	2 5/64	38 1 1/2	46 1 13/16	0.6 1.3	0.6 1.3	0.8 1.8
F204D1 F204D1	<b>Z(ZM)-UCF203D1</b> <b>Z(ZM)-UCF203-011D1</b>	<b>C(CM)-UCF203D1</b> <b>C(CM)-UCF203-011D1</b>	2 5/64	38 1 1/2	46 1 13/16	0.6 1.3	0.6 1.3	0.8 1.8
F204D1 F204D1	<b>Z(ZM)-UCF204D1</b> <b>Z(ZM)-UCF204-012D1</b>	<b>C(CM)-UCF204D1</b> <b>C(CM)-UCF204-012D1</b>	2 5/64	38 1 1/2	46 1 13/16	0.6 1.3	0.6 1.3	0.7 1.5
F205D1 F205D1 F205D1 F205D1 F205D1	<b>Z(ZM)-UCF205D1</b> <b>Z(ZM)-UCF205-013D1</b> <b>Z(ZM)-UCF205-014D1</b> <b>Z(ZM)-UCF205-015D1</b> <b>Z(ZM)-UCF205-100D1</b>	<b>C(CM)-UCF205D1</b> <b>C(CM)-UCF205-013D1</b> <b>C(CM)-UCF205-014D1</b> <b>C(CM)-UCF205-015D1</b> <b>C(CM)-UCF205-100D1</b>	2 5/64	40 1 19/32	51 2	0.8 1.8	0.8 1.8	0.9 2.0
F206D1 F206D1 F206D1 F206D1	<b>Z(ZM)-UCF206D1</b> <b>Z(ZM)-UCF206-101D1</b> <b>Z(ZM)-UCF206-102D1</b> <b>Z(ZM)-UCF206-103D1</b> -	<b>C(CM)-UCF206D1</b> <b>C(CM)-UCF206-101D1</b> <b>C(CM)-UCF206-102D1</b> <b>C(CM)-UCF206-103D1</b> <b>C(CM)-UCF206-104D1</b>	2 5/64	45 1 3/4	56 2 7/32	1.1 2.4	1.1 2.4	1.3 2.9
F207D1 F207D1 F207D1 F207D1 F207D1	<b>Z(ZM)-UCF207D1</b> <b>Z(ZM)-UCF207-104D1</b> <b>Z(ZM)-UCF207-105D1</b> <b>Z(ZM)-UCF207-106D1</b> -	<b>C(CM)-UCF207D1</b> <b>C(CM)-UCF207-104D1</b> <b>C(CM)-UCF207-105D1</b> <b>C(CM)-UCF207-106D1</b> <b>C(CM)-UCF207-107D1</b>	3 1/8	49 1 15/16	59 2 5/16	1.5 3.3	1.5 3.3	1.8 4.0
F208D1 F208D1 F208D1	<b>Z(ZM)-UCF208D1</b> <b>Z(ZM)-UCF208-108D1</b> <b>Z(ZM)-UCF208-109D1</b>	<b>C(CM)-UCF208D1</b> <b>C(CM)-UCF208-108D1</b> <b>C(CM)-UCF208-109D1</b>	3 1/8	56 2 3/16	66 2 19/32	1.7 3.7	1.8 4.0	2.2 4.9
F209D1 F209D1 F209D1 F209D1	<b>Z(ZM)-UCF209D1</b> <b>Z(ZM)-UCF209-110D1</b> <b>Z(ZM)-UCF209-111D1</b> <b>Z(ZM)-UCF209-112D1</b>	<b>C(CM)-UCF209D1</b> <b>C(CM)-UCF209-110D1</b> <b>C(CM)-UCF209-111D1</b> <b>C(CM)-UCF209-112D1</b>	3 1/8	57 2 1/4	70 2 3/4	2.1 4.6	2.2 4.9	2.6 5.7

## Square flanged unit, cast housing Set screw type

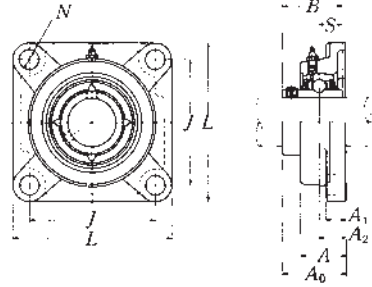

Shaft dia. mm inch	Unit number (*)	Nominal dimensions									Bolt size mm inch	Bearing number
		mm inch										
		L	J	A <sub>2</sub>	A <sub>1</sub>	A	N	A <sub>0</sub>	B	S		
50 1 3/16 1 7/8 1 5/16 2	<b>UCF210D1</b> <b>UCF210-113D1</b> <b>UCF210-114D1</b> <b>UCF210-115D1</b> <b>UCF210-200D1</b>	143	111	22	16	40	16	54.6	51.6	19	M14	<b>UC210D1</b> UC210-113D1 UC210-114D1 UC210-115D1 UC210-200D1
		5 5/8	4 3/8	55/64	5/8	1 9/16	5/8	2 5/32	2.0315	0.748	1/2	
55 2 2 1/16 2 1/8 2 3/16	<b>UCF211D1</b> <b>UCF211-200D1</b> <b>UCF211-201D1</b> <b>UCF211-202D1</b> <b>UCF211-203D1</b>	162	130	25	18	43	19	58.4	55.6	22.2	M16	<b>UC211D1</b> UC211-200D1 UC211-201D1 UC211-202D1 UC211-203D1
		6 3/8	5 1/8	63/64	23/32	1 11/16	3/4	2 19/64	2.1890	0.874	5/8	
60 2 1/4 2 1/16 2 3/8 2 7/16	<b>UCF212D1</b> <b>UCF212-204D1</b> <b>UCF212-205D1</b> <b>UCF212-206D1</b> <b>UCF212-207D1</b>	175	143	29	18	48	19	68.7	65.1	25.4	M16	<b>UC212D1</b> UC212-204D1 UC212-205D1 UC212-206D1 UC212-207D1
		6 7/8	5 5/8	1 9/64	23/32	1 7/8	3/4	2 45/64	2.5630	1.000	5/8	
65 2 1/2 2 9/16	<b>UCF213D1</b> <b>UCF213-208D1</b> <b>UCF213-209D1</b>	187	149	30	22	50	19	69.7	65.1	25.4	M16	<b>UC213D1</b> UC213-208D1 UC213-209D1
		7 3/8	5 55/64	1 3/16	7/8	1 31/32	3/4	2 3/4	2.5630	1.000	5/8	
70 2 5/8 2 1/16 2 3/4	<b>UCF214D1</b> <b>UCF214-210D1</b> <b>UCF214-211D1</b> <b>UCF214-212D1</b>	193	152	31	22	54	19	75.4	74.6	30.2	M16	<b>UC214D1</b> UC214-210D1 UC214-211D1 UC214-212D1
		7 19/32	5 63/64	1 7/32	7/8	2 1/8	3/4	2 31/32	2.9370	1.189	5/8	
75 2 3/16 2 7/8 2 15/16 3	<b>UCF215D1</b> <b>UCF215-213D1</b> <b>UCF215-214D1</b> <b>UCF215-215D1</b> <b>UCF215-300D1</b>	200	159	34	22	56	19	78.5	77.8	33.3	M16	<b>UC215D1</b> UC215-213D1 UC215-214D1 UC215-215D1 UC215-300D1
		7 7/8	6 17/64	1 11/32	7/8	2 7/32	3/4	3 3/32	3.0630	1.311	5/8	
80 3 1/16 3 1/8 3 3/16	<b>UCF216D1</b> <b>UCF216-301D1</b> <b>UCF216-302D1</b> <b>UCF216-303D1</b>	208	165	34	22	58	23	83.3	82.6	33.3	M20	<b>UC216D1</b> UC216-301D1 UC216-302D1 UC216-303D1
		8 3/16	6 1/2	1 11/32	7/8	2 9/32	29/32	3 3/32	3.2520	1.311	3/4	

Note (\*) These numbers indicate relubricatable type. If maintenance free type is needed, please order without suffix "D1".

Remarks Please refer to page A21 for size of grease fitting.

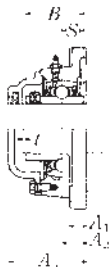
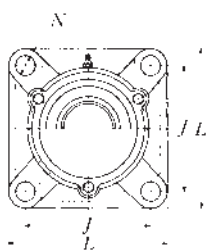
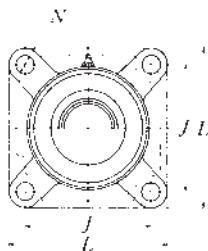

**Pressed steel dust cover type**

Open end **Z-UCF...D1**

Closed end **ZM-UCF...D1**

**Cast dust cover type**

Open end **C-UCF...D1**

Closed end **CM-UCF...D1**

Housing number	Unit number (*) pressed steel dust cover type	Unit number (*) cast dust cover type	Nominal dimensions			Mass of unit		
			mm inch			kg lb		
			t max.	A <sub>4</sub>	A <sub>5</sub>	UCF	Z(ZM)	C(CM)
F210D1	<b>Z(ZM)-UCF210D1</b>	<b>C(CM)-UCF210D1</b>	3	60	72	2.5	2.5	3.0
F210D1	<b>Z(ZM)-UCF210-113D1</b>	<b>C(CM)-UCF210-113D1</b>						
F210D1	<b>Z(ZM)-UCF210-114D1</b>	<b>C(CM)-UCF210-114D1</b>						
F210D1	<b>Z(ZM)-UCF210-115D1</b>	<b>C(CM)-UCF210-115D1</b>	1/8	2 3/8	2 27/32	5.5	5.5	6.6
F210D1		<b>C(CM)-UCF210-200D1</b>						
F211D1	<b>Z(ZM)-UCF211D1</b>	<b>C(CM)-UCF211D1</b>	4	64	75	3.3	3.4	4.0
F211D1	<b>Z(ZM)-UCF211-200D1</b>	<b>C(CM)-UCF211-200D1</b>						
F211D1	<b>Z(ZM)-UCF211-201D1</b>	<b>C(CM)-UCF211-201D1</b>						
F211D1	<b>Z(ZM)-UCF211-202D1</b>	<b>C(CM)-UCF211-202D1</b>	5/32	2 1/2	2 15/16	7.3	7.5	8.8
F211D1	<b>Z(ZM)-UCF211-203D1</b>	<b>C(CM)-UCF211-203D1</b>						
F212D1	<b>Z(ZM)-UCF212D1</b>	<b>C(CM)-UCF212D1</b>	4	74	86	3.9	4.1	4.8
F212D1	<b>Z(ZM)-UCF212-204D1</b>	<b>C(CM)-UCF212-204D1</b>						
F212D1	<b>Z(ZM)-UCF212-205D1</b>	<b>C(CM)-UCF212-205D1</b>						
F212D1	<b>Z(ZM)-UCF212-206D1</b>	<b>C(CM)-UCF212-206D1</b>	5/32	2 29/32	3 3/8	8.6	9.0	11
F212D1		<b>C(CM)-UCF212-207D1</b>						
F213D1	<b>Z(ZM)-UCF213D1</b>	<b>C(CM)-UCF213D1</b>	4	76	90	5.5	5.6	6.4
F213D1	<b>Z(ZM)-UCF213-208D1</b>	<b>C(CM)-UCF213-208D1</b>	5/32	3	3 17/32	12	12	14
F213D1	<b>Z(ZM)-UCF213-209D1</b>	<b>C(CM)-UCF213-209D1</b>						
F214D1		<b>C(CM)-UCF214D1</b>	4	-	98	6.3	-	7.4
F214D1		<b>C(CM)-UCF214-210D1</b>						
F214D1		<b>C(CM)-UCF214-211D1</b>	5/32	-	3 27/32	14	-	16
F214D1		<b>C(CM)-UCF214-212D1</b>						
F215D1		<b>C(CM)-UCF215D1</b>	4	-	102	6.6	-	7.9
F215D1		<b>C(CM)-UCF215-213D1</b>						
F215D1		<b>C(CM)-UCF215-214D1</b>						
F215D1		<b>C(CM)-UCF215-215D1</b>	5/32	-	4 1/32	15	-	17
F215D1		<b>C(CM)-UCF215-300D1</b>						
F216D1		<b>C(CM)-UCF216D1</b>	4	-	106	7.9	-	9.3
F216D1		<b>C(CM)-UCF216-301D1</b>						
F216D1		<b>C(CM)-UCF216-302D1</b>	5/32	-	4 3/16	17	-	21
F216D1		<b>C(CM)-UCF216-303D1</b>						

## Square flanged unit, cast housing Set screw type

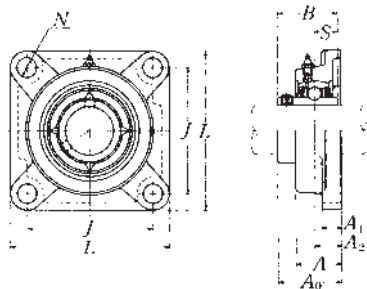

Shaft dia. mm inch	Unit number <sup>(1)</sup>	Nominal dimensions										Bolt size mm inch	Bearing number
		mm inch											
		<i>L</i>	<i>J</i>	<i>A</i> <sub>2</sub>	<i>A</i> <sub>1</sub>	<i>A</i>	<i>N</i>	<i>A</i> <sub>0</sub>	<i>B</i>	<i>S</i>			
85 3 1/4	<b>UCF217D1</b>	220	175	36	24	63	23	87.6	85.7	34.1	M20	UC217D1	
3 5/16	<b>UCF217-304D1</b>											UC217-304D1	
3 7/16	<b>UCF217-305D1</b>	8 21/32	6 57/64	1 27/64	1 5/16	2 15/32	2 9/32	3 29/64	3.3740	1.343	3/4	UC217-305D1	
3 7/16	<b>UCF217-307D1</b>											UC217-307D1	
90 3 1/2	<b>UCF218D1</b>	235	187	40	24	68	23	96.3	96	39.7	M20	UC218D1	
	<b>UCF218-308D1</b>	9 1/4	7 23/64	1 37/64	1 5/16	2 11/16	2 9/32	3 51/64	3.7795	1.563	3/4	UC218-308D1	

**Note** (1) These numbers indicate relubricatable type. If maintenance free type is needed, please order without suffix "D1".

**Remarks** Please refer to page **A21** for size of grease fitting.

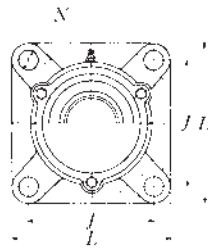
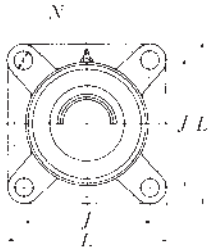

**Pressed steel dust cover type**

Open end **Z-UCF...D1**  
 Closed end **ZM-UCF...D1**

**Cast dust cover type**

Open end **C-UCF...D1**  
 Closed end **CM-UCF...D1**

Housing number	Unit number (*) pressed steel dust cover type	Unit number (*) cast dust cover type	Nominal dimensions			Mass of unit		
			<i>t</i> max.	<i>A</i> <sub>4</sub>	<i>A</i> <sub>5</sub>	UCF	Z(ZM)	C(CM)
F217D1	–	<b>C(CM)-UCF217D1</b>	5	–	114	9.8	–	12
F217D1	–	<b>C(CM)-UCF217-304D1</b>	$\frac{13}{64}$	–	$4\frac{1}{2}$	22	–	26
F217D1	–	<b>C(CM)-UCF217-305D1</b>						
F217D1	–	<b>C(CM)-UCF217-307D1</b>						
F218D1	–	<b>C(CM)-UCF218D1</b>	5	–	122	12	–	13
F218D1	–	<b>C(CM)-UCF218-308D1</b>	$\frac{13}{64}$	–	$4\frac{13}{16}$	26	–	29

## Square flanged unit, cast housing Set screw type

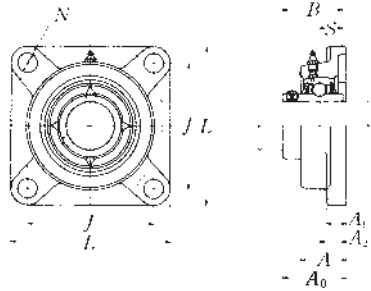

Shaft dia. mm inch	Unit number (1)	Nominal dimensions									Bolt size mm inch
		mm inch									
		L	J	A <sub>2</sub>	A <sub>1</sub>	A	N	A <sub>0</sub>	B	S	
25	<b>UCF305D1</b>	110	80	16	13	29	16	39	38	15	M14
$\frac{13}{16}$	<b>UCF305-013D1</b>										
$\frac{7}{8}$	<b>UCF305-014D1</b>	$4\frac{11}{32}$	$3\frac{5}{32}$	$\frac{5}{8}$	$\frac{1}{2}$	$1\frac{5}{32}$	$\frac{5}{8}$	$1\frac{17}{32}$	1.4961	0.591	$\frac{1}{2}$
$\frac{15}{16}$	<b>UCF305-015D1</b>										
1	<b>UCF305-100D1</b>										
30	<b>UCF306D1</b>	125	95	18	15	32	16	44	43	17	M14
$\frac{1}{16}$	<b>UCF306-101D1</b>										
$\frac{1}{8}$	<b>UCF306-102D1</b>	$4\frac{29}{32}$	$3\frac{47}{64}$	$\frac{45}{64}$	$\frac{19}{32}$	$1\frac{1}{4}$	$\frac{5}{8}$	$1\frac{47}{64}$	1.6929	0.669	$\frac{1}{2}$
$\frac{1}{16}$	<b>UCF306-103D1</b>										
35	<b>UCF307D1</b>	135	100	20	16	36	19	49	48	19	M16
$\frac{1}{4}$	<b>UCF307-104D1</b>										
$\frac{5}{16}$	<b>UCF307-105D1</b>	$5\frac{5}{16}$	$3\frac{15}{16}$	$\frac{25}{32}$	$\frac{5}{8}$	$1\frac{13}{32}$	$\frac{3}{4}$	$1\frac{59}{64}$	1.8898	0.748	$\frac{5}{8}$
$\frac{3}{8}$	<b>UCF307-106D1</b>										
$\frac{7}{16}$	<b>UCF307-107D1</b>										
40	<b>UCF308D1</b>	150	112	23	17	40	19	56	52	19	M16
$\frac{1}{2}$	<b>UCF308-108D1</b>										
$\frac{7}{16}$	<b>UCF308-109D1</b>	$5\frac{29}{32}$	$4\frac{19}{32}$	$\frac{29}{32}$	$\frac{21}{32}$	$1\frac{9}{16}$	$\frac{3}{4}$	$2\frac{19}{64}$	2.0472	0.748	$\frac{5}{8}$
45	<b>UCF309D1</b>	160	125	25	18	44	19	60	57	22	M16
$\frac{5}{8}$	<b>UCF309-110D1</b>										
$\frac{11}{16}$	<b>UCF309-111D1</b>	$6\frac{5}{16}$	$4\frac{59}{64}$	$\frac{63}{64}$	$\frac{23}{32}$	$1\frac{23}{32}$	$\frac{3}{4}$	$2\frac{23}{64}$	2.2441	0.866	$\frac{5}{8}$
$\frac{1}{4}$	<b>UCF309-112D1</b>										
50	<b>UCF310D1</b>	175	132	28	19	48	23	67	61	22	M20
$\frac{13}{16}$	<b>UCF310-113D1</b>										
$\frac{1}{8}$	<b>UCF310-114D1</b>	$6\frac{7}{8}$	$5\frac{19}{64}$	$1\frac{7}{64}$	$\frac{3}{4}$	$1\frac{7}{8}$	$\frac{29}{32}$	$2\frac{1}{64}$	2.4016	0.866	$\frac{3}{4}$
$\frac{15}{16}$	<b>UCF310-115D1</b>										
55	<b>UCF311D1</b>	185	140	30	20	52	23	71	66	25	M20
2	<b>UCF311-200D1</b>										
$\frac{2}{16}$	<b>UCF311-201D1</b>	$7\frac{9}{32}$	$5\frac{39}{64}$	$1\frac{3}{16}$	$\frac{25}{32}$	$2\frac{1}{16}$	$\frac{29}{32}$	$2\frac{51}{64}$	2.5984	0.984	$\frac{3}{4}$
$\frac{2}{8}$	<b>UCF311-202D1</b>										
$\frac{2}{16}$	<b>UCF311-203D1</b>										

Note (1) These numbers indicate relubricatable type. If maintenance free type is needed, please order without suffix "D1".

Remarks Please refer to page A21 for size of grease fitting.

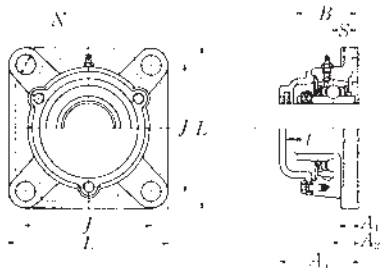

**Cast dust cover type**  
 Open end **C-UCF...D1**  
 Closed end **CM-UCF...D1**

Bearing number	Housing number	Unit number (1) cast dust cover type	Nominal dimensions		Mass of unit	
			<i>t</i> max.	<i>A</i> <sub>5</sub> inch	UCF	C(CM)
UC305D1	F305D1	<b>C(CM)-UCF305D1</b>	2	56	1.1	1.4
UC305-013D1	F305D1	<b>C(CM)-UCF305-013D1</b>	5/64	2 7/32	2.4	3.1
UC305-014D1	F305D1	<b>C(CM)-UCF305-014D1</b>				
UC305-015D1	F305D1	<b>C(CM)-UCF305-015D1</b>				
UC305-100D1	F305D1	<b>C(CM)-UCF305-100D1</b>				
UC306D1	F306D1	<b>C(CM)-UCF306D1</b>	2	60	1.6	2.1
UC306-101D1	F306D1	<b>C(CM)-UCF306-101D1</b>	5/64	2 3/8	3.5	4.6
UC306-102D1	F306D1	<b>C(CM)-UCF306-102D1</b>				
UC306-103D1	F306D1	<b>C(CM)-UCF306-103D1</b>				
UC307D1	F307D1	<b>C(CM)-UCF307D1</b>	3	68	2.1	2.6
UC307-104D1	F307D1	<b>C(CM)-UCF307-104D1</b>	1/8	2 11/16	4.6	5.7
UC307-105D1	F307D1	<b>C(CM)-UCF307-105D1</b>				
UC307-106D1	F307D1	<b>C(CM)-UCF307-106D1</b>				
UC307-107D1	F307D1	<b>C(CM)-UCF307-107D1</b>				
UC308D1	F308D1	<b>C(CM)-UCF308D1</b>	3	76	2.7	3.4
UC308-108D1	F308D1	<b>C(CM)-UCF308-108D1</b>	1/8	3	6.0	7.5
UC308-109D1	F308D1	<b>C(CM)-UCF308-109D1</b>				
UC309D1	F309D1	<b>C(CM)-UCF309D1</b>	3	80	3.4	4.3
UC309-110D1	F309D1	<b>C(CM)-UCF309-110D1</b>	1/8	3 5/32	7.5	9.5
UC309-111D1	F309D1	<b>C(CM)-UCF309-111D1</b>				
UC309-112D1	F309D1	<b>C(CM)-UCF309-112D1</b>				
UC310D1	F310D1	<b>C(CM)-UCF310D1</b>	3	88	4.5	5.8
UC310-113D1	F310D1	<b>C(CM)-UCF310-113D1</b>	1/8	3 15/32	9.9	13
UC310-114D1	F310D1	<b>C(CM)-UCF310-114D1</b>				
UC310-115D1	F310D1	<b>C(CM)-UCF310-115D1</b>				
UC311D1	F311D1	<b>C(CM)-UCF311D1</b>	4	92	5.3	6.7
UC311-200D1	F311D1	<b>C(CM)-UCF311-200D1</b>	5/32	3 5/8	12	15
UC311-201D1	F311D1	<b>C(CM)-UCF311-201D1</b>				
UC311-202D1	F311D1	<b>C(CM)-UCF311-202D1</b>				
UC311-203D1	F311D1	<b>C(CM)-UCF311-203D1</b>				



## Square flanged unit, cast housing Set screw type

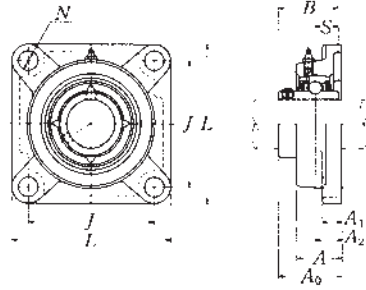

Shaft dia. mm inch	Unit number (1)	Nominal dimensions									Bolt size mm inch
		mm inch									
		L	J	A <sub>2</sub>	A <sub>1</sub>	A	N	A <sub>0</sub>	B	S	
60 2 1/4 2 5/16 2 3/8 2 7/16	<b>UCF312D1</b> <b>UCF312-204D1</b> <b>UCF312-205D1</b> <b>UCF312-206D1</b> <b>UCF312-207D1</b>	195	150	33	22	56	23	78	71	26	M20
		7 11/16	5 29/32	1 19/64	7/8	2 7/32	29/32	3 5/64	2.7953	1.024	3/4
65 2 1/2 2 9/16	<b>UCF313D1</b> <b>UCF313-208D1</b> <b>UCF313-209D1</b>	208	166	33	22	58	23	78	75	30	M20
		8 3/16	6 17/32	1 19/64	7/8	2 9/32	29/32	3 5/64	2.9528	1.181	3/4
70 2 5/8 2 7/16 2 3/4	<b>UCF314D1</b> <b>UCF314-210D1</b> <b>UCF314-211D1</b> <b>UCF314-212D1</b>	226	178	36	25	61	25	81	78	33	M22
		8 29/32	6 1/4	1 27/64	31/32	2 13/32	63/64	3 3/16	3.0709	1.299	7/8
75 2 13/16 2 7/8 2 5/16 3	<b>UCF315D1</b> <b>UCF315-213D1</b> <b>UCF315-214D1</b> <b>UCF315-215D1</b> <b>UCF315-300D1</b>	236	184	39	25	66	25	89	82	32	M22
		9 9/32	7 1/4	1 17/32	31/32	2 19/32	63/64	3 1/2	3.2283	1.260	7/8
80 3 1/16 3 3/8 3 7/16	<b>UCF316D1</b> <b>UCF316-301D1</b> <b>UCF316-302D1</b> <b>UCF316-303D1</b>	250	196	38	27	68	31	90	86	34	M27
		9 27/32	7 23/32	1 1/2	1 1/16	2 1/16	1 7/32	3 35/64	3.3858	1.339	1
85 3 3/4 3 5/16 3 7/16	<b>UCF317D1</b> <b>UCF317-304D1</b> <b>UCF317-305D1</b> <b>UCF317-307D1</b>	260	204	44	27	74	31	100	96	40	M27
		10 1/4	8 1/32	1 47/64	1 1/16	2 29/32	1 7/32	3 7/16	3.7795	1.575	1
90 3 7/16 3 1/2	<b>UCF318D1</b> <b>UCF318-307D1</b> <b>UCF318-308D1</b>	280	216	44	30	76	35	100	96	40	M30
		11 1/32	8 1/2	1 47/64	1 3/16	3	1 3/8	3 7/16	3.7795	1.575	1 1/8

**Note** (1) These numbers indicate relubricatable type. If maintenance free type is needed, please order without suffix "D1".

**Remarks** Please refer to page A21 for size of grease fitting.

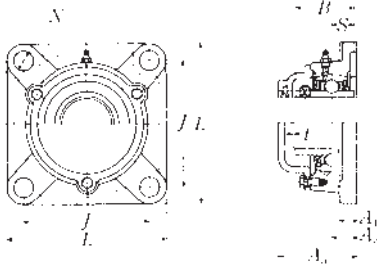

**Cast dust cover type**

Open end **C-UCF...D1**  
 Closed end **CM-UCF...D1**

Bearing number	Housing number	Unit number (*) cast dust cover type	Nominal dimensions		Mass of unit	
			mm	inch	kg	lb
			<i>t</i> max.	<i>A</i> <sub>5</sub>	UCF	C(CM)
UC312D1	F312D1	<b>C(CM)-UCF312D1</b>	4	100	6.3	7.8
UC312-204D1	F312D1	<b>C(CM)-UCF312-204D1</b>	$\frac{5}{32}$	$3\frac{15}{16}$	14	17
UC312-205D1	F312D1	<b>C(CM)-UCF312-205D1</b>				
UC312-206D1	F312D1	<b>C(CM)-UCF312-206D1</b>				
UC312-207D1	F312D1	<b>C(CM)-UCF312-207D1</b>				
UC313D1	F313D1	<b>C(CM)-UCF313D1</b>	4	103	8.0	9.7
UC313-208D1	F313D1	<b>C(CM)-UCF313-208D1</b>	$\frac{5}{32}$	$4\frac{1}{16}$	18	21
UC313-209D1	F313D1	<b>C(CM)-UCF313-209D1</b>				
UC314D1	F314D1	<b>C(CM)-UCF314D1</b>	4	106	9.4	11
UC314-210D1	F314D1	<b>C(CM)-UCF314-210D1</b>	$\frac{5}{32}$	$4\frac{3}{16}$	21	24
UC314-211D1	F314D1	<b>C(CM)-UCF314-211D1</b>				
UC314-212D1	F314D1	<b>C(CM)-UCF314-212D1</b>				
UC315D1	F315D1	<b>C(CM)-UCF315D1</b>	4	114	11	13
UC315-213D1	F315D1	<b>C(CM)-UCF315-213D1</b>	$\frac{5}{32}$	$4\frac{1}{2}$	24	29
UC315-214D1	F315D1	<b>C(CM)-UCF315-214D1</b>				
UC315-215D1	F315D1	<b>C(CM)-UCF315-215D1</b>				
UC315-300D1	F315D1	<b>C(CM)-UCF315-300D1</b>				
UC316D1	F316D1	<b>C(CM)-UCF316D1</b>	4	116	14	16
UC316-301D1	F316D1	<b>C(CM)-UCF316-301D1</b>	$\frac{5}{32}$	$4\frac{9}{16}$	31	35
UC316-302D1	F316D1	<b>C(CM)-UCF316-302D1</b>				
UC316-303D1	F316D1	<b>C(CM)-UCF316-303D1</b>				
UC317D1	F317D1	<b>C(CM)-UCF317D1</b>	5	129	15	19
UC317-304D1	F317D1	<b>C(CM)-UCF317-304D1</b>	$\frac{13}{64}$	$5\frac{3}{32}$	33	42
UC317-305D1	F317D1	<b>C(CM)-UCF317-305D1</b>				
UC317-307D1	F317D1	<b>C(CM)-UCF317-307D1</b>				
UC318D1	F318D1	<b>C(CM)-UCF318D1</b>	5	129	19	23
UC318-307D1	F318D1	<b>C(CM)-UCF318-307D1</b>	$\frac{13}{64}$	$5\frac{3}{32}$	42	51
UC318-308D1	F318D1	<b>C(CM)-UCF318-308D1</b>				

## Square flanged unit, cast housing Set screw type

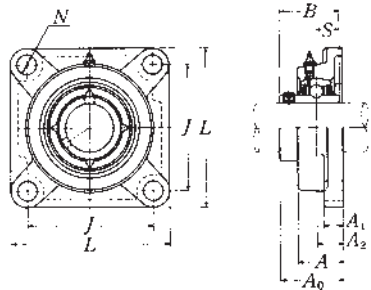

Shaft dia.  mm inch	Unit number <sup>(1)</sup>	Nominal dimensions									Bolt size  mm inch
		mm inch									
		<i>L</i>	<i>J</i>	<i>A</i> <sub>2</sub>	<i>A</i> <sub>1</sub>	<i>A</i>	<i>N</i>	<i>A</i> <sub>0</sub>	<i>B</i>	<i>S</i>	
95 3 <sup>5</sup> / <sub>8</sub>	<b>UCF319D1</b>	290	228	59	30	94	35	121	103	41	M30
3 <sup>1</sup> / <sub>8</sub>	<b>UCF319-310D1</b>	11 <sup>19</sup> / <sub>32</sub>	8 <sup>3</sup> / <sub>32</sub>	2 <sup>21</sup> / <sub>64</sub>	1 <sup>3</sup> / <sub>16</sub>	3 <sup>1</sup> / <sub>16</sub>	1 <sup>3</sup> / <sub>8</sub>	4 <sup>49</sup> / <sub>64</sub>	4.0551	1.614	1 <sup>1</sup> / <sub>8</sub>
3 <sup>1</sup> / <sub>16</sub>	<b>UCF319-311D1</b>										
3 <sup>3</sup> / <sub>4</sub>	<b>UCF319-312D1</b>										
100 3 <sup>13</sup> / <sub>16</sub>	<b>UCF320D1</b>	310	242	59	32	94	38	125	108	42	M33
3 <sup>7</sup> / <sub>8</sub>	<b>UCF320-313D1</b>	12 <sup>7</sup> / <sub>32</sub>	9 <sup>17</sup> / <sub>32</sub>	2 <sup>21</sup> / <sub>64</sub>	1 <sup>1</sup> / <sub>4</sub>	3 <sup>1</sup> / <sub>16</sub>	1 <sup>1</sup> / <sub>2</sub>	4 <sup>59</sup> / <sub>64</sub>	4.2520	1.654	1 <sup>1</sup> / <sub>4</sub>
3 <sup>15</sup> / <sub>16</sub>	<b>UCF320-314D1</b>										
4	<b>UCF320-315D1</b> <b>UCF320-400D1</b>										
105	<b>UCF321D1</b>	310	242	59	32	94	38	127	112	44	M33
110	<b>UCF322D1</b>	340	266	60	35	96	41	131	117	46	M36
120	<b>UCF324D1</b>	370	290	65	40	110	41	140	126	51	M36
130	<b>UCF326D1</b>	410	320	65	45	115	41	146	135	54	M36
140	<b>UCF328D1</b>	450	350	75	55	125	41	161	145	59	M36

**Note (1)** These numbers indicate relubricatable type. If maintenance free type is needed, please order without suffix "D1".

**Remarks** Please refer to page **A21** for size of grease fitting.

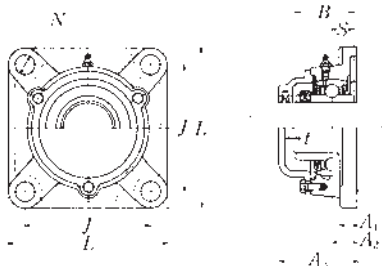

**Cast dust cover type**  
 Open end **C-UCF...D1**  
 Closed end **CM-UCF...D1**

Bearing number	Housing number	Unit number (*) cast dust cover type	Nominal dimensions		Mass of unit	
			mm	inch	kg	lb
UC319D1	F319D1	<b>C(CM)-UCF319D1</b>	5	149	22	25
UC319-310D1	F319D1	<b>C(CM)-UCF319-310D1</b>				
UC319-311D1	F319D1	<b>C(CM)-UCF319-311D1</b>	$\frac{13}{64}$	$5\frac{7}{8}$	49	55
UC319-312D1	F319D1	<b>C(CM)-UCF319-312D1</b>				
UC320D1	F320D1	<b>C(CM)-UCF320D1</b>	5	154	27	32
UC320-313D1	F320D1	<b>C(CM)-UCF320-313D1</b>				
UC320-314D1	F320D1	<b>C(CM)-UCF320-314D1</b>	$\frac{13}{64}$	$6\frac{1}{16}$	60	71
UC320-315D1	F320D1	<b>C(CM)-UCF320-315D1</b>				
UC320-400D1	F320D1	<b>C(CM)-UCF320-400D1</b>				
UC321D1	F321D1	<b>C(CM)-UCF321D1</b>	5	156	26	32
UC322D1	F322D1	<b>C(CM)-UCF322D1</b>	5	160	34	40
UC324D1	F324D1	<b>C(CM)-UCF324D1</b>	5	172	48	56
UC326D1	F326D1	<b>C(CM)-UCF326D1</b>	6	178	63	73
UC328D1	F328D1	<b>C(CM)-UCF328D1</b>	6	192	90	100

## Square flanged unit, cast housing Set screw type

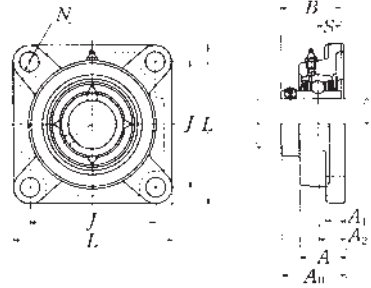

Shaft dia. mm inch	Unit number <sup>(1)</sup>	Nominal dimensions									Bolt size mm inch
		mm inch									
		<i>L</i>	<i>J</i>	<i>A</i> <sub>2</sub>	<i>A</i> <sub>1</sub>	<i>A</i>	<i>N</i>	<i>A</i> <sub>0</sub>	<i>B</i>	<i>S</i>	
25 1 <sup>3</sup> / <sub>16</sub> 7 <sup>7</sup> / <sub>8</sub> 1 <sup>15</sup> / <sub>16</sub> 1	<b>UCFX05D1</b> <b>UCFX05-013D1</b> <b>UCFX05-014D1</b> <b>UCFX05-015D1</b> <b>UCFX05-100D1</b>	108	83	18	13	30	12	40.2	38.1	15.9	M10
		4 <sup>1</sup> / <sub>4</sub>	3 <sup>17</sup> / <sub>64</sub>	4 <sup>5</sup> / <sub>64</sub>	1 <sup>1</sup> / <sub>2</sub>	1 <sup>3</sup> / <sub>16</sub>	1 <sup>15</sup> / <sub>32</sub>	1 <sup>37</sup> / <sub>64</sub>	1.5000	0.626	3 <sup>3</sup> / <sub>8</sub>
30 1 <sup>1</sup> / <sub>16</sub> 1 <sup>1</sup> / <sub>8</sub> 1 <sup>3</sup> / <sub>16</sub> 1 <sup>1</sup> / <sub>4</sub>	<b>UCFX06D1</b> <b>UCFX06-101D1</b> <b>UCFX06-102D1</b> <b>UCFX06-103D1</b> <b>UCFX06-104D1</b>	117	92	19	14	34	16	44.4	42.9	17.5	M14
		4 <sup>19</sup> / <sub>32</sub>	3 <sup>5</sup> / <sub>8</sub>	3 <sup>3</sup> / <sub>4</sub>	9 <sup>9</sup> / <sub>16</sub>	1 <sup>11</sup> / <sub>32</sub>	5 <sup>5</sup> / <sub>8</sub>	1 <sup>3</sup> / <sub>4</sub>	1.6890	0.689	1 <sup>1</sup> / <sub>2</sub>
35 1 <sup>5</sup> / <sub>16</sub> 1 <sup>3</sup> / <sub>8</sub> 1 <sup>7</sup> / <sub>16</sub>	<b>UCFX07D1</b> <b>UCFX07-105D1</b> <b>UCFX07-106D1</b> <b>UCFX07-107D1</b>	130	102	21	14	38	16	51.2	49.2	19	M14
		5 <sup>1</sup> / <sub>8</sub>	4 <sup>1</sup> / <sub>64</sub>	5 <sup>3</sup> / <sub>64</sub>	9 <sup>9</sup> / <sub>16</sub>	1 <sup>1</sup> / <sub>2</sub>	5 <sup>5</sup> / <sub>8</sub>	2 <sup>1</sup> / <sub>64</sub>	1.9370	0.748	1 <sup>1</sup> / <sub>2</sub>
40 1 <sup>1</sup> / <sub>2</sub> 1 <sup>7</sup> / <sub>16</sub>	<b>UCFX08D1</b> <b>UCFX08-108D1</b> <b>UCFX08-109D1</b>	137	105	22	14	40	19	52.2	49.2	19	M16
		5 <sup>15</sup> / <sub>32</sub>	4 <sup>3</sup> / <sub>64</sub>	5 <sup>5</sup> / <sub>64</sub>	9 <sup>9</sup> / <sub>16</sub>	1 <sup>9</sup> / <sub>16</sub>	3 <sup>3</sup> / <sub>4</sub>	2 <sup>1</sup> / <sub>16</sub>	1.9370	0.748	5 <sup>5</sup> / <sub>8</sub>
45 1 <sup>5</sup> / <sub>8</sub> 1 <sup>11</sup> / <sub>16</sub> 1 <sup>1</sup> / <sub>4</sub> 1 <sup>13</sup> / <sub>16</sub>	<b>UCFX09D1</b> <b>UCFX09-110D1</b> <b>UCFX09-111D1</b> <b>UCFX09-112D1</b> <b>UCFX09-113D1</b>	143	111	23	14	40	19	55.6	51.6	19	M16
		5 <sup>5</sup> / <sub>8</sub>	4 <sup>3</sup> / <sub>8</sub>	2 <sup>29</sup> / <sub>32</sub>	9 <sup>9</sup> / <sub>16</sub>	1 <sup>9</sup> / <sub>16</sub>	3 <sup>3</sup> / <sub>4</sub>	2 <sup>3</sup> / <sub>16</sub>	2.0315	0.748	5 <sup>5</sup> / <sub>8</sub>
50 1 <sup>7</sup> / <sub>8</sub> 1 <sup>15</sup> / <sub>16</sub> 2	<b>UCFX10D1</b> <b>UCFX10-114D1</b> <b>UCFX10-115D1</b> <b>UCFX10-200D1</b>	162	130	26	20	44	19	59.4	55.6	22.2	M16
		6 <sup>3</sup> / <sub>8</sub>	5 <sup>1</sup> / <sub>8</sub>	1 <sup>1</sup> / <sub>32</sub>	2 <sup>25</sup> / <sub>32</sub>	1 <sup>23</sup> / <sub>32</sub>	3 <sup>3</sup> / <sub>4</sub>	2 <sup>11</sup> / <sub>32</sub>	2.1890	0.874	5 <sup>5</sup> / <sub>8</sub>

Note <sup>(1)</sup> These numbers indicate relubricatable type. If maintenance free type is needed, please order without suffix "D1".

Remarks Please refer to page A21 for size of grease fitting.

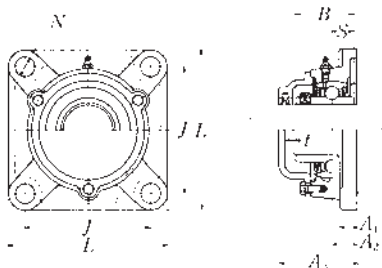

**Cast dust cover type**  
 Open end **C-UCF...D1**  
 Closed end **CM-UCF...D1**

Bearing number	Housing number	Unit number (*) cast dust cover type	Nominal dimensions		Mass of unit	
			mm	inch	kg lb	
			<i>t</i> max.	<i>A</i> <sub>5</sub>	UCF	C(CM)
UCX05D1	FX05D1	<b>C(CM)-UCFX05D1</b>	2	56	1.1	1.3
UCX05-013D1	FX05D1	<b>C(CM)-UCFX05-013D1</b>				
UCX05-014D1	FX05D1	<b>C(CM)-UCFX05-014D1</b>				
UCX05-015D1	FX05D1	<b>C(CM)-UCFX05-015D1</b>	$\frac{5}{64}$	$2\frac{7}{32}$	2.4	2.9
UCX05-100D1	FX05D1	<b>C(CM)-UCFX05-100D1</b>				
UCX06D1	FX06D1	<b>C(CM)-UCFX06D1</b>	2	59	1.7	1.9
UCX06-101D1	FX06D1	<b>C(CM)-UCFX06-101D1</b>				
UCX06-102D1	FX06D1	<b>C(CM)-UCFX06-102D1</b>				
UCX06-103D1	FX06D1	<b>C(CM)-UCFX06-103D1</b>	$\frac{5}{64}$	$2\frac{9}{16}$	3.7	4.2
UC207-104D1	FX06D1	<b>C(CM)-UCFX06-104D1</b>				
UCX07D1	FX07D1	<b>C(CM)-UCFX07D1</b>	3	66	2.1	2.5
UCX07-105D1	FX07D1	<b>C(CM)-UCFX07-105D1</b>				
UCX07-106D1	FX07D1	<b>C(CM)-UCFX07-106D1</b>	$\frac{1}{8}$	$2\frac{19}{32}$	4.6	5.5
UCX07-107D1	FX07D1	<b>C(CM)-UCFX07-107D1</b>				
UCX08D1	FX08D1	<b>C(CM)-UCFX08D1</b>	3	70	2.3	2.7
UCX08-108D1	FX08D1	<b>C(CM)-UCFX08-108D1</b>				
UCX08-109D1	FX08D1	<b>C(CM)-UCFX08-109D1</b>	$\frac{1}{8}$	$2\frac{3}{4}$	5.1	6.0
UCX09D1	FX09D1	<b>C(CM)-UCFX09D1</b>	3	73	2.5	3.0
UCX09-110D1	FX09D1	<b>C(CM)-UCFX09-110D1</b>				
UCX09-111D1	FX09D1	<b>C(CM)-UCFX09-111D1</b>				
UCX09-112D1	FX09D1	<b>C(CM)-UCFX09-112D1</b>	$\frac{1}{8}$	$2\frac{7}{8}$	5.5	6.6
UC210-113D1	FX09D1	<b>C(CM)-UCFX09-113D1</b>				
UCX10D1	FX10D1	<b>C(CM)-UCFX10D1</b>	3	76	3.8	4.3
UCX10-114D1	FX10D1	<b>C(CM)-UCFX10-114D1</b>				
UCX10-115D1	FX10D1	<b>C(CM)-UCFX10-115D1</b>				
UC211-200D1	FX10D1	<b>C(CM)-UCFX10-200D1</b>	$\frac{1}{8}$	3	8.4	9.5

## Square flanged unit, cast housing Set screw type

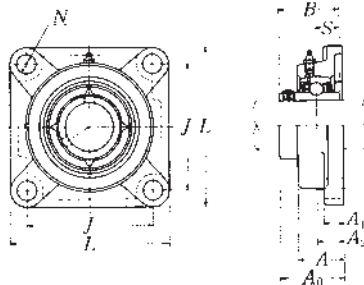

Shaft dia. mm inch	Unit number (1)	Nominal dimensions									Bolt size mm inch
		mm inch									
		<i>L</i>	<i>J</i>	<i>A</i> <sub>2</sub>	<i>A</i> <sub>1</sub>	<i>A</i>	<i>N</i>	<i>A</i> <sub>0</sub>	<i>B</i>	<i>S</i>	
55	<b>UCFX11D1</b>	175	143	29	20	49	19	68.7	65.1	25.4	M16
2 1/16	<b>UCFX11-201D1</b>										
2 1/8	<b>UCFX11-202D1</b>										
2 3/16	<b>UCFX11-203D1</b>	6 7/8	5 5/8	1 9/64	25/32	1 15/16	3/4	2 45/64	2.5630	1.000	5/8
2 1/4	<b>UCFX11-204D1</b>										
2 5/16	<b>UCFX11-205D1</b>										
60	<b>UCFX12D1</b>	187	149	34	21	59	19	73.7	65.1	25.4	M16
2 3/8	<b>UCFX12-206D1</b>										
2 1/2	<b>UCFX12-207D1</b>	7 3/8	5 55/64	1 11/32	13/16	2 5/16	3/4	2 29/32	2.5630	1.000	5/8
65	<b>UCFX13D1</b>	187	149	34	21	59	19	78.4	74.6	30.2	M16
2 1/2	<b>UCFX13-208D1</b>										
2 1/8	<b>UCFX13-209D1</b>	7 3/8	5 55/64	1 11/32	13/16	2 5/16	3/4	3 3/32	2.9370	1.189	5/8
70	<b>UCFX14D1</b>	197	152	37	24	60	23	81.5	77.8	33.3	M20
2 5/8	<b>UCFX14-210D1</b>										
2 11/16	<b>UCFX14-211D1</b>	7 3/4	5 53/64	1 29/64	15/16	2 3/8	29/32	3 13/64	3.0630	1.311	3/4
2 3/4	<b>UCFX14-212D1</b>										
75	<b>UCFX15D1</b>	197	152	40	24	68	23	89.3	82.6	33.3	M20
2 3/16	<b>UCFX15-213D1</b>										
2 7/8	<b>UCFX15-214D1</b>										
2 5/16	<b>UCFX15-215D1</b>	7 3/4	5 53/64	1 37/64	15/16	2 1/16	29/32	3 33/64	3.2520	1.311	3/4
3	<b>UCFX15-300D1</b>										
80	<b>UCFX16D1</b>	214	171	40	24	70	23	91.6	85.7	34.1	M20
3 1/16	<b>UCFX16-301D1</b>										
3 1/8	<b>UCFX16-302D1</b>										
3 3/16	<b>UCFX16-303D1</b>	8 7/16	6 47/64	1 37/64	15/16	2 3/4	29/32	3 39/64	3.3740	1.343	3/4
3 1/4	<b>UCFX16-304D1</b>										

Note (1) These numbers indicate relubricatable type. If maintenance free type is needed, please order without suffix "D1".

Remarks Please refer to page A21 for size of grease fitting.

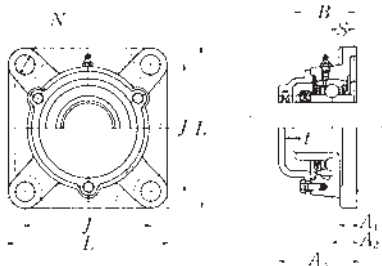

**Cast dust cover type**  
 Open end **C-UCF...D1**  
 Closed end **CM-UCF...D1**

Bearing number	Housing number	Unit number (*) cast dust cover type	Nominal dimensions		Mass of unit	
			mm	inch	kg	lb
			<i>t</i> max.	<i>A</i> <sub>5</sub>	UCF	C(CM)
UCX11D1	FX11D1	<b>C(CM)-UCFX11D1</b>	4	86	4.8	5.5
UCX11-201D1	FX11D1	<b>C(CM)-UCFX11-201D1</b>				
UCX11-202D1	FX11D1	<b>C(CM)-UCFX11-202D1</b>				
UCX11-203D1	FX11D1	<b>C(CM)-UCFX11-203D1</b>	$\frac{5}{32}$	$3\frac{3}{8}$	11	12
UC212-204D1	FX11D1	<b>C(CM)-UCFX11-204D1</b>				
UC212-205D1	FX11D1	<b>C(CM)-UCFX11-205D1</b>				
UCX12D1	FX12D1	<b>C(CM)-UCFX12D1</b>	4	94	6.4	7.3
UCX12-206D1	FX12D1	<b>C(CM)-UCFX12-206D1</b>	$\frac{5}{32}$	$3\frac{1}{16}$	14	16
UCX12-207D1	FX12D1	<b>C(CM)-UCFX12-207D1</b>				
UCX13D1	FX13D1	<b>C(CM)-UCFX13D1</b>	4	101	6.7	7.8
UCX13-208D1	FX13D1	<b>C(CM)-UCFX13-208D1</b>	$\frac{5}{32}$	$3\frac{1}{32}$	15	17
UCX13-209D1	FX13D1	<b>C(CM)-UCFX13-209D1</b>				
UCX14D1	FX14D1	<b>C(CM)-UCFX14D1</b>	4	105	7.1	8.3
UCX14-210D1	FX14D1	<b>C(CM)-UCFX14-210D1</b>				
UCX14-211D1	FX14D1	<b>C(CM)-UCFX14-211D1</b>	$\frac{5}{32}$	$4\frac{1}{8}$	16	18
UCX14-212D1	FX14D1	<b>C(CM)-UCFX14-212D1</b>				
UCX15D1	FX15D1	<b>C(CM)-UCFX15D1</b>	4	112	8.6	9.9
UCX15-213D1	FX15D1	<b>C(CM)-UCFX15-213D1</b>				
UCX15-214D1	FX15D1	<b>C(CM)-UCFX15-214D1</b>				
UCX15-215D1	FX15D1	<b>C(CM)-UCFX15-215D1</b>	$\frac{5}{32}$	$4\frac{19}{32}$	19	22
UCX15-300D1	FX15D1	<b>C(CM)-UCFX15-300D1</b>				
UCX16D1	FX16D1	<b>C(CM)-UCFX16D1</b>	4	118	11	12
UCX16-301D1	FX16D1	<b>C(CM)-UCFX16-301D1</b>				
UCX16-302D1	FX16D1	<b>C(CM)-UCFX16-302D1</b>				
UCX16-303D1	FX16D1	<b>C(CM)-UCFX16-303D1</b>	$\frac{5}{32}$	$4\frac{21}{32}$	24	26
UC217-304D1	FX16D1	<b>C(CM)-UCFX16-304D1</b>				



## Square flanged unit, cast housing Set screw type

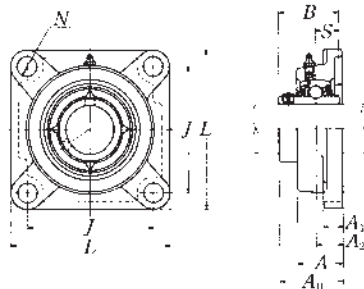

Shaft dia. mm inch	Unit number (1)	Nominal dimensions									Bolt size mm inch
		mm inch									
		<i>L</i>	<i>J</i>	<i>A</i> <sub>2</sub>	<i>A</i> <sub>1</sub>	<i>A</i>	<i>N</i>	<i>A</i> <sub>0</sub>	<i>B</i>	<i>S</i>	
85	<b>UCFX17D1</b>	214	171	40	24	70	23	96.3	96	39.7	M20
3 <sup>5</sup> / <sub>16</sub>	<b>UCFX17-305D1</b>	8 <sup>7</sup> / <sub>16</sub>	6 <sup>47</sup> / <sub>64</sub>	1 <sup>37</sup> / <sub>64</sub>	1 <sup>5</sup> / <sub>16</sub>	2 <sup>3</sup> / <sub>4</sub>	2 <sup>9</sup> / <sub>32</sub>	3 <sup>51</sup> / <sub>64</sub>	3.7795	1.563	<sup>3</sup> / <sub>4</sub>
3 <sup>7</sup> / <sub>16</sub>	<b>UCFX17-307D1</b>										
90	<b>UCFX18D1</b>	214	171	45	24	76	23	106.1	104	42.9	M20
3 <sup>7</sup> / <sub>16</sub>	<b>UCFX18-307D1</b>	8 <sup>7</sup> / <sub>16</sub>	6 <sup>47</sup> / <sub>64</sub>	1 <sup>49</sup> / <sub>64</sub>	1 <sup>5</sup> / <sub>16</sub>	3	2 <sup>9</sup> / <sub>32</sub>	4 <sup>11</sup> / <sub>64</sub>	4.0945	1.689	<sup>3</sup> / <sub>4</sub>
3 <sup>1</sup> / <sub>2</sub>	<b>UCFX18-308D1</b>										
100	<b>UCFX20D1</b>	268	211	59	31	97	31	127.3	117.5	49.2	M27
3 <sup>13</sup> / <sub>16</sub>	<b>UCFX20-313D1</b>										
3 <sup>7</sup> / <sub>8</sub>	<b>UCFX20-314D1</b>										
3 <sup>15</sup> / <sub>16</sub>	<b>UCFX20-315D1</b>	10 <sup>9</sup> / <sub>16</sub>	8 <sup>5</sup> / <sub>16</sub>	2 <sup>21</sup> / <sub>64</sub>	1 <sup>7</sup> / <sub>32</sub>	3 <sup>13</sup> / <sub>16</sub>	1 <sup>7</sup> / <sub>32</sub>	5 <sup>1</sup> / <sub>64</sub>	4.6260	1.937	1
4	<b>UCFX20-400D1</b>										

Note (1) These numbers indicate relubricatable type. If maintenance free type is needed, please order without suffix "D1".

Remarks Please refer to page A21 for size of grease fitting.

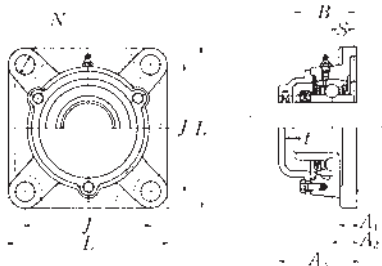

**Cast dust cover type**  
 Open end **C-UCF...D1**  
 Closed end **CM-UCF...D1**

Bearing number	Housing number	Unit number (*) cast dust cover type	Nominal dimensions		Mass of unit	
			mm	inch	kg	lb
			<i>t</i> max.	<i>A</i> <sub>5</sub>	UCF	C(CM)
UCX17D1	FX17D1	<b>C(CM)-UCFX17D1</b>	5	122	12	14
UCX17-305D1	FX17D1	<b>C(CM)-UCFX17-305D1</b>	$\frac{13}{64}$	$4\frac{13}{16}$	26	31
UCX17-307D1	FX17D1	<b>C(CM)-UCFX17-307D1</b>				
UCX18D1	FX18D1	<b>C(CM)-UCFX18D1</b>	5	135	13	15
UCX18-307D1	FX18D1	<b>C(CM)-UCFX18-307D1</b>	$\frac{13}{64}$	$5\frac{5}{16}$	29	33
UCX18-308D1	FX18D1	<b>C(CM)-UCFX18-308D1</b>				
UCX20D1	FX20D1	<b>C(CM)-UCFX20D1</b>	5	146.5	21	23
UCX20-313D1	FX20D1	<b>C(CM)-UCFX20-313D1</b>				
UCX20-314D1	FX20D1	<b>C(CM)-UCFX20-314D1</b>				
UCX20-315D1	FX20D1	<b>C(CM)-UCFX20-315D1</b>	$\frac{13}{64}$	$5\frac{25}{32}$	46	51
UCX20-400D1	FX20D1	<b>C(CM)-UCFX20-400D1</b>				

## Square flanged unit, cast housing with spigot joint Set screw type

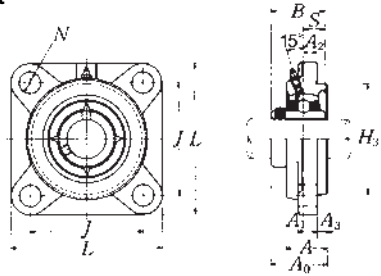

Shaft dia. mm inch	Unit number (1)	Nominal dimensions											Bolt size mm inch
		mm inch											
		L	J	A <sub>2</sub>	N	A <sub>3</sub>	A <sub>1</sub>	A	H <sub>3</sub>	A <sub>0</sub>	B	S	
25 13/16 7/8 15/16 1	<b>UCFS305D1</b> <b>UCFS305-013D1</b> <b>UCFS305-014D1</b> <b>UCFS305-015D1</b> <b>UCFS305-100D1</b>	110	80	9	16	7	13	29	80	39	38	15	M14    1/2
30 1 1/16 1 1/8 1 3/16	<b>UCFS306D1</b> <b>UCFS306-101D1</b> <b>UCFS306-102D1</b> <b>UCFS306-103D1</b>	125	95	10	16	8	15	32	90	44	43	17	M14   1/2
35 1 1/4 1 5/16 1 3/8 1 7/16	<b>UCFS307D1</b> <b>UCFS307-104D1</b> <b>UCFS307-105D1</b> <b>UCFS307-106D1</b> <b>UCFS307-107D1</b>	135	100	11	19	9	16	36	100	49	48	19	M16   5/8
40 1 1/2 1 9/16	<b>UCFS308D1</b> <b>UCFS308-108D1</b> <b>UCFS308-109D1</b>	150	112	13	19	10	17	40	115	56	52	19	M16  5/8
45 1 5/8 1 11/16 1 3/4	<b>UCFS309D1</b> <b>UCFS309-110D1</b> <b>UCFS309-111D1</b> <b>UCFS309-112D1</b>	160	125	14	19	11	18	44	125	60	57	22	M16  5/8
50 1 13/16 1 7/8 1 15/16	<b>UCFS310D1</b> <b>UCFS310-113D1</b> <b>UCFS310-114D1</b> <b>UCFS310-115D1</b>	175	132	16	23	12	19	48	140	67	61	22	M20  3/4

Note (1) These numbers indicate relubricatable type. If maintenance free type is needed, please order without suffix "D1".

Remarks Please refer to page A21 for size of grease fitting.

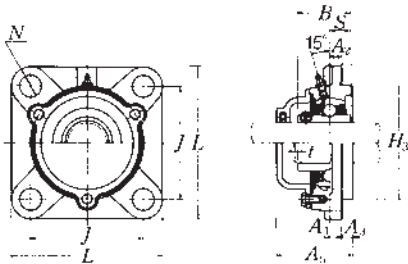

**Cast dust cover type**

Open end **C-UCFS...D1**

Closed end **CM-UCFS...D1**

Bearing number	Housing number	Unit number (1) cast dust cover type	Nominal dimensions		Mass of unit	
			mm	inch	kg	lb
			$t$ max.	$A_5$	UCFS	C(CM)
UC305D1	FS305D1	<b>C(CM)-UCFS305D1</b>	2	56	1.2	1.4
UC305-013D1	FS305D1	<b>C(CM)-UCFS305-013D1</b>				
UC305-014D1	FS305D1	<b>C(CM)-UCFS305-014D1</b>				
UC305-015D1	FS305D1	<b>C(CM)-UCFS305-015D1</b>	$\frac{5}{64}$	$2\frac{13}{64}$	2.6	3.1
UC305-100D1	FS305D1	<b>C(CM)-UCFS305-100D1</b>				
UC306D1	FS306D1	<b>C(CM)-UCFS306D1</b>	2	60	1.8	2.2
UC306-101D1	FS306D1	<b>C(CM)-UCFS306-101D1</b>				
UC306-102D1	FS306D1	<b>C(CM)-UCFS306-102D1</b>	$\frac{5}{64}$	$2\frac{29}{64}$	4.0	4.9
UC306-103D1	FS306D1	<b>C(CM)-UCFS306-103D1</b>				
UC307D1	FS307D1	<b>C(CM)-UCFS307D1</b>	3	67	2.3	2.8
UC307-104D1	FS307D1	<b>C(CM)-UCFS307-104D1</b>				
UC307-105D1	FS307D1	<b>C(CM)-UCFS307-105D1</b>				
UC307-106D1	FS307D1	<b>C(CM)-UCFS307-106D1</b>	$\frac{1}{8}$	$2\frac{11}{64}$	5.1	6.2
UC307-107D1	FS307D1	<b>C(CM)-UCFS307-107D1</b>				
UC308D1	FS308D1	<b>C(CM)-UCFS308D1</b>	3	76	3.1	3.6
UC308-108D1	FS308D1	<b>C(CM)-UCFS308-108D1</b>				
UC308-109D1	FS308D1	<b>C(CM)-UCFS308-109D1</b>	$\frac{1}{8}$	$2\frac{63}{64}$	6.8	7.9
UC309D1	FS309D1	<b>C(CM)-UCFS309D1</b>	3	80	3.8	4.7
UC309-110D1	FS309D1	<b>C(CM)-UCFS309-110D1</b>				
UC309-111D1	FS309D1	<b>C(CM)-UCFS309-111D1</b>	$\frac{1}{8}$	$3\frac{5}{32}$	8.4	10
UC309-112D1	FS309D1	<b>C(CM)-UCFS309-112D1</b>				
UC310D1	FS310D1	<b>C(CM)-UCFS310D1</b>	3	88	5.0	6.2
UC310-113D1	FS310D1	<b>C(CM)-UCFS310-113D1</b>				
UC310-114D1	FS310D1	<b>C(CM)-UCFS310-114D1</b>	$\frac{1}{8}$	$3\frac{15}{32}$	11	14
UC310-115D1	FS310D1	<b>C(CM)-UCFS310-115D1</b>				

## Square flanged unit, cast housing with spigot joint Set screw type

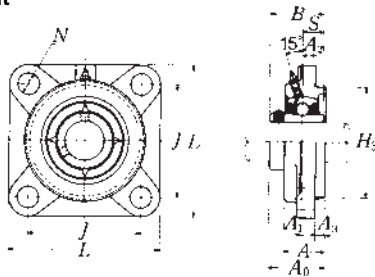

Shaft dia. mm inch	Unit number (1)	Nominal dimensions											Bolt size mm inch
		mm inch											
		L	J	A <sub>2</sub>	N	A <sub>3</sub>	A <sub>1</sub>	A	H <sub>3</sub>	A <sub>0</sub>	B	S	
55	<b>UCFS311D1</b>	185	140	17	23	13	20	52	150	71	66	25	M20
2	<b>UCFS311-200D1</b>												
2 1/16	<b>UCFS311-201D1</b>	7 9/32	5 33/64	43/64	29/32	33/64	25/32	2 3/64	5.9055	2 51/64	2.5984	0.984	3/4
2 1/8	<b>UCFS311-202D1</b>												
2 3/16	<b>UCFS311-203D1</b>												
60	<b>UCFS312D1</b>	195	150	19	23	14	22	56	160	78	71	26	M20
2 1/4	<b>UCFS312-204D1</b>												
2 5/16	<b>UCFS312-205D1</b>	7 11/16	5 29/32	3/4	29/32	35/64	7/8	2 13/64	6.2992	3 5/64	2.7953	1.024	3/4
2 3/8	<b>UCFS312-206D1</b>												
2 7/16	<b>UCFS312-207D1</b>												
65	<b>UCFS313D1</b>	208	166	15	23	18	22	58	175	78	75	30	M20
2 1/2	<b>UCFS313-208D1</b>												
2 9/16	<b>UCFS313-209D1</b>	8 3/16	6 17/32	19/32	29/32	45/64	7/8	2 9/32	6.8898	3 5/64	2.9528	1.181	3/4
70	<b>UCFS314D1</b>	226	178	18	25	18	25	61	185	81	78	33	M22
2 5/8	<b>UCFS314-210D1</b>												
2 11/16	<b>UCFS314-211D1</b>	8 29/32	7 1/64	45/64	63/64	45/64	31/32	2 13/32	7.2835	3 3/16	3.0709	1.299	7/8
2 3/4	<b>UCFS314-212D1</b>												
75	<b>UCFS315D1</b>	236	184	21	25	18	25	66	200	89	82	32	M22
2 13/16	<b>UCFS315-213D1</b>												
2 7/8	<b>UCFS315-214D1</b>	9 9/32	7 1/4	53/64	63/64	45/64	31/32	2 19/32	7.8740	3 1/2	3.2283	1.260	7/8
2 15/16	<b>UCFS315-215D1</b>												
3	<b>UCFS315-300D1</b>												
80	<b>UCFS316D1</b>	250	196	18	31	20	27	68	210	90	86	34	M27
3 1/16	<b>UCFS316-301D1</b>												
3 1/8	<b>UCFS316-302D1</b>	9 27/32	7 23/32	45/64	1 7/32	25/32	1 1/16	2 13/64	8.2677	3 35/64	3.3858	1.339	1
3 3/16	<b>UCFS316-303D1</b>												

Note (1) These numbers indicate relubricatable type. If maintenance free type is needed, please order without suffix "D1".

Remarks Please refer to page A21 for size of grease fitting.

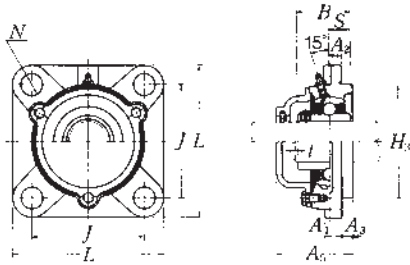

**Cast dust cover type**  
 Open end **C-UCFS...D1**  
 Closed end **CM-UCFS...D1**

Bearing number	Housing number	Unit number (1) cast dust cover type	Nominal dimensions		Mass of unit	
			mm	inch	kg	lb
			$t$ max.	$A_5$	UCFS	C(CM)
UC311D1	FS311D1	<b>C(CM)-UCFS311D1</b>	4	93	5.9	7.2
UC311-200D1	FS311D1	<b>C(CM)-UCFS311-200D1</b>				
UC311-201D1	FS311D1	<b>C(CM)-UCFS311-201D1</b>				
UC311-202D1	FS311D1	<b>C(CM)-UCFS311-202D1</b>	$\frac{5}{32}$	$3\frac{21}{32}$	13	16
UC311-203D1	FS311D1	<b>C(CM)-UCFS311-203D1</b>				
UC312D1	FS312D1	<b>C(CM)-UCFS312D1</b>	4	100	7.0	8.4
UC312-204D1	FS312D1	<b>C(CM)-UCFS312-204D1</b>				
UC312-205D1	FS312D1	<b>C(CM)-UCFS312-205D1</b>				
UC312-206D1	FS312D1	<b>C(CM)-UCFS312-206D1</b>	$\frac{5}{32}$	$3\frac{15}{16}$	15	19
UC312-207D1	FS312D1	<b>C(CM)-UCFS312-207D1</b>				
UC313D1	FS313D1	<b>C(CM)-UCFS313D1</b>	4	103	8.6	10
UC313-208D1	FS313D1	<b>C(CM)-UCFS313-208D1</b>				
UC313-209D1	FS313D1	<b>C(CM)-UCFS313-209D1</b>	$\frac{5}{32}$	$4\frac{1}{16}$	19	22
UC314D1	FS314D1	<b>C(CM)-UCFS314D1</b>	4	106	10	12
UC314-210D1	FS314D1	<b>C(CM)-UCFS314-210D1</b>				
UC314-211D1	FS314D1	<b>C(CM)-UCFS314-211D1</b>	$\frac{5}{32}$	$4\frac{11}{64}$	22	26
UC314-212D1	FS314D1	<b>C(CM)-UCFS314-212D1</b>				
UC315D1	FS315D1	<b>C(CM)-UCFS315D1</b>	4	114	12	14
UC315-213D1	FS315D1	<b>C(CM)-UCFS315-213D1</b>				
UC315-214D1	FS315D1	<b>C(CM)-UCFS315-214D1</b>				
UC315-215D1	FS315D1	<b>C(CM)-UCFS315-215D1</b>	$\frac{5}{32}$	$4\frac{31}{64}$	26	31
UC315-300D1	FS315D1	<b>C(CM)-UCFS315-300D1</b>				
UC316D1	FS316D1	<b>C(CM)-UCFS316D1</b>	4	116	14	17
UC316-301D1	FS316D1	<b>C(CM)-UCFS316-301D1</b>				
UC316-302D1	FS316D1	<b>C(CM)-UCFS316-302D1</b>				
UC316-303D1	FS316D1	<b>C(CM)-UCFS316-303D1</b>	$\frac{5}{32}$	$4\frac{9}{16}$	31	37

## Square flanged unit, cast housing with spigot joint Set screw type

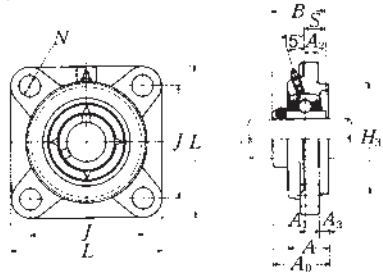

Shaft dia. mm inch	Unit number (1)	Nominal dimensions											Bolt size mm inch
		L	J	A <sub>2</sub>	N	A <sub>3</sub>	A <sub>1</sub>	A	H <sub>3</sub>	A <sub>0</sub>	B	S	
85 3 1/4	<b>UCFS317D1</b>	260	204	24	31	20	27	74	220	100	96	40	M27
3 5/16	<b>UCFS317-304D1</b>	10 1/4	8 1/32	1 5/16	1 7/32	2 25/32	1 1/16	2 29/32	8.6614	3 15/16	3.7795	1.575	1
3 7/16	<b>UCFS317-305D1</b>												
	<b>UCFS317-307D1</b>												
90 3 7/16	<b>UCFS318D1</b>	280	216	24	35	20	30	76	240	100	96	40	M30
3 1/2	<b>UCFS318-307D1</b>	11 1/32	8 1/2	1 5/16	1 3/8	2 25/32	1 3/16	2 59/64	9.4488	3 15/16	3.7795	1.575	1 1/8
	<b>UCFS318-308D1</b>												
95 3 5/8	<b>UCFS319D1</b>	290	228	39	35	20	30	94	250	121	103	41	M30
3 11/16	<b>UCFS319-310D1</b>	11 13/32	8 31/32	1 17/32	1 3/8	2 25/32	1 3/16	3 45/64	9.8425	4 49/64	4.0551	1.614	1 1/8
3 3/4	<b>UCFS319-311D1</b>												
	<b>UCFS319-312D1</b>												
100 3 13/16	<b>UCFS320D1</b>	310	242	39	38	20	32	94	260	125	108	42	M33
3 7/8	<b>UCFS320-313D1</b>	12 7/32	9 17/32	1 17/32	1 1/2	2 25/32	1 1/4	3 45/64	10.2362	4 59/64	4.2520	1.654	1 1/4
3 15/16	<b>UCFS320-314D1</b>												
4	<b>UCFS320-315D1</b>												
	<b>UCFS320-400D1</b>												
105	<b>UCFS321D1</b>	310	242	39	38	20	32	94	260	127	112	44	M33
110	<b>UCFS322D1</b>	340	266	35	41	25	35	96	300	131	117	46	M36
120	<b>UCFS324D1</b>	370	290	35	41	30	40	110	330	140	126	51	M36
130	<b>UCFS326D1</b>	410	320	35	41	30	45	115	360	146	135	54	M36
140	<b>UCFS328D1</b>	450	350	45	41	30	55	125	400	161	145	59	M36

**Note** (1) These numbers indicate relubricatable type. If maintenance free type is needed, please order without suffix "D1".

**Remarks** Please refer to page A21 for size of grease fitting.

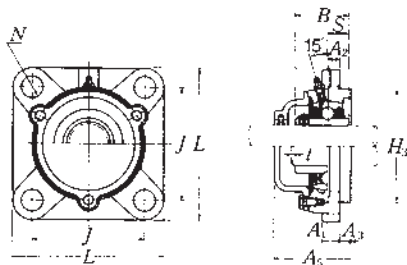

**Cast dust cover type**  
 Open end **C-UCFS...D1**  
 Closed end **CM-UCFS...D1**

Bearing number	Housing number	Unit number (1) cast dust cover type	Nominal dimensions		Mass of unit	
			mm	inch	kg	lb
			<i>t</i> max.	<i>A</i> <sub>5</sub>	UCFS	C(CM)
UC317D1	FS317D1	<b>C(CM)-UCFS317D1</b>	5	129	17	20
UC317-304D1	FS317D1	<b>C(CM)-UCFS317-304D1</b>				
UC317-305D1	FS317D1	<b>C(CM)-UCFS317-305D1</b>	$\frac{13}{64}$	$5\frac{5}{64}$	37	44
UC317-307D1	FS317D1	<b>C(CM)-UCFS317-307D1</b>				
UC318D1	FS318D1	<b>C(CM)-UCFS318D1</b>	5	129	20	24
UC318-307D1	FS318D1	<b>C(CM)-UCFS318-307D1</b>				
UC318-308D1	FS318D1	<b>C(CM)-UCFS318-308D1</b>	$\frac{13}{64}$	$5\frac{5}{64}$	44	53
UC319D1	FS319D1	<b>C(CM)-UCFS319D1</b>	5	149	24	28
UC319-310D1	FS319D1	<b>C(CM)-UCFS319-310D1</b>				
UC319-311D1	FS319D1	<b>C(CM)-UCFS319-311D1</b>	$\frac{13}{64}$	$5\frac{55}{64}$	53	62
UC319-312D1	FS319D1	<b>C(CM)-UCFS319-312D1</b>				
UC320D1	FS320D1	<b>C(CM)-UCFS320D1</b>	5	154	29	34
UC320-313D1	FS320D1	<b>C(CM)-UCFS320-313D1</b>				
UC320-314D1	FS320D1	<b>C(CM)-UCFS320-314D1</b>				
UC320-315D1	FS320D1	<b>C(CM)-UCFS320-315D1</b>	$\frac{13}{64}$	$6\frac{1}{16}$	64	75
UC320-400D1	FS320D1	<b>C(CM)-UCFS320-400D1</b>				
UC321D1	FS321D1	<b>C(CM)-UCFS321D1</b>	5	156	28	33
UC322D1	FS322D1	<b>C(CM)-UCFS322D1</b>	5	160	38	45
UC324D1	FS324D1	<b>C(CM)-UCFS324D1</b>	5	172	52	59
UC326D1	FS326D1	<b>C(CM)-UCFS326D1</b>	6	178	69	77
UC328D1	FS328D1	<b>C(CM)-UCFS328D1</b>	6	192	98	109



## Round flanged unit, cast housing with spigot joint Set screw type

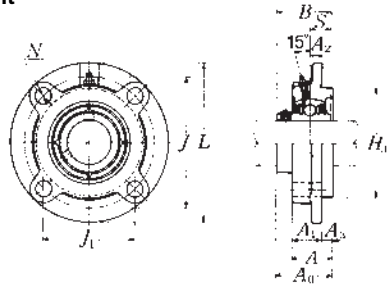

Shaft dia. mm inch	Unit number (1)	Nominal dimensions											Bolt size mm inch	
		mm inch												
		L	J	(J <sub>1</sub> )	A <sub>2</sub>	N	A <sub>3</sub>	A <sub>1</sub>	A	H <sub>3</sub>	A <sub>0</sub>	B	S	
12	UCFC201D1	100	78	55.2	10	12	5	20.5	25.5	62	33.3	31	12.7	M10
1/2	UCFC201-008D1	3 <sup>15</sup> / <sub>16</sub>	3 <sup>5</sup> / <sub>64</sub>	2 <sup>1</sup> / <sub>64</sub>	25 <sup>25</sup> / <sub>64</sub>	15 <sup>15</sup> / <sub>32</sub>	13 <sup>13</sup> / <sub>64</sub>	13 <sup>13</sup> / <sub>16</sub>	1	2.4409	1 <sup>15</sup> / <sub>16</sub>	1.2205	0.500	3/8
15	UCFC202D1	100	78	55.2	10	12	5	20.5	25.5	62	33.3	31	12.7	M10
9/16	UCFC202-009D1	3 <sup>15</sup> / <sub>16</sub>	3 <sup>5</sup> / <sub>64</sub>	2 <sup>1</sup> / <sub>64</sub>	25 <sup>25</sup> / <sub>64</sub>	15 <sup>15</sup> / <sub>32</sub>	13 <sup>13</sup> / <sub>64</sub>	13 <sup>13</sup> / <sub>16</sub>	1	2.4409	1 <sup>5</sup> / <sub>16</sub>	1.2205	0.500	3/8
5/8	UCFC202-010D1	3 <sup>15</sup> / <sub>16</sub>	3 <sup>5</sup> / <sub>64</sub>	2 <sup>1</sup> / <sub>64</sub>	25 <sup>25</sup> / <sub>64</sub>	15 <sup>15</sup> / <sub>32</sub>	13 <sup>13</sup> / <sub>64</sub>	13 <sup>13</sup> / <sub>16</sub>	1	2.4409	1 <sup>5</sup> / <sub>16</sub>	1.2205	0.500	3/8
17	UCFC203D1	100	78	55.2	10	12	5	20.5	25.5	62	33.3	31	12.7	M10
1 1/16	UCFC203-011D1	3 <sup>15</sup> / <sub>16</sub>	3 <sup>5</sup> / <sub>64</sub>	2 <sup>1</sup> / <sub>64</sub>	25 <sup>25</sup> / <sub>64</sub>	15 <sup>15</sup> / <sub>32</sub>	13 <sup>13</sup> / <sub>64</sub>	13 <sup>13</sup> / <sub>16</sub>	1	2.4409	1 <sup>5</sup> / <sub>16</sub>	1.2205	0.500	3/8
20	UCFC204D1	100	78	55.2	10	12	5	20.5	25.5	62	33.3	31	12.7	M10
3/4	UCFC204-012D1	3 <sup>15</sup> / <sub>16</sub>	3 <sup>5</sup> / <sub>64</sub>	2 <sup>1</sup> / <sub>64</sub>	25 <sup>25</sup> / <sub>64</sub>	15 <sup>15</sup> / <sub>32</sub>	13 <sup>13</sup> / <sub>64</sub>	13 <sup>13</sup> / <sub>16</sub>	1	2.4409	1 <sup>5</sup> / <sub>16</sub>	1.2205	0.500	3/8
25	UCFC205D1	115	90	63.6	10	12	6	21	27	70	35.8	34.1	14.3	M10
1 3/16	UCFC205-013D1													
7/8	UCFC205-014D1	4 <sup>17</sup> / <sub>32</sub>	3 <sup>35</sup> / <sub>64</sub>	2 <sup>1</sup> / <sub>2</sub>	25 <sup>25</sup> / <sub>64</sub>	15 <sup>15</sup> / <sub>32</sub>	15 <sup>15</sup> / <sub>64</sub>	13 <sup>13</sup> / <sub>16</sub>	1 <sup>1</sup> / <sub>16</sub>	2.7559	1 <sup>13</sup> / <sub>32</sub>	1.3425	0.563	3/8
15/16	UCFC205-015D1													
1	UCFC205-100D1													
30	UCFC206D1	125	100	70.7	10	12	8	23	31	80	40.2	38.1	15.9	M10
1 1/16	UCFC206-101D1													
1 1/8	UCFC206-102D1	4 <sup>29</sup> / <sub>32</sub>	3 <sup>5</sup> / <sub>16</sub>	2 <sup>25</sup> / <sub>32</sub>	25 <sup>25</sup> / <sub>64</sub>	15 <sup>15</sup> / <sub>32</sub>	5 <sup>5</sup> / <sub>16</sub>	29 <sup>29</sup> / <sub>32</sub>	1 <sup>7</sup> / <sub>32</sub>	3.1496	1 <sup>37</sup> / <sub>64</sub>	1.5000	0.629	3/8
1 3/16	UCFC206-103D1													
1 1/4	UCFC206-104D1													
35	UCFC207D1	135	110	77.8	11	14	8	26	34	90	44.4	42.9	17.5	M12
1 1/4	UCFC207-104D1													
1 5/16	UCFC207-105D1	5 <sup>5</sup> / <sub>16</sub>	4 <sup>21</sup> / <sub>64</sub>	3 <sup>1</sup> / <sub>16</sub>	7 <sup>7</sup> / <sub>16</sub>	35 <sup>35</sup> / <sub>64</sub>	5 <sup>5</sup> / <sub>16</sub>	1 <sup>1</sup> / <sub>32</sub>	1 <sup>11</sup> / <sub>32</sub>	3.5433	1 <sup>3</sup> / <sub>4</sub>	1.6890	0.689	7/16
1 3/8	UCFC207-106D1													
1 7/16	UCFC207-107D1													
40	UCFC208D1	145	120	84.9	11	14	10	26	36	100	51.2	49.2	19	M12
1 1/2	UCFC208-108D1	5 <sup>23</sup> / <sub>32</sub>	4 <sup>23</sup> / <sub>32</sub>	3 <sup>1</sup> / <sub>32</sub>	7 <sup>7</sup> / <sub>16</sub>	35 <sup>35</sup> / <sub>64</sub>	25 <sup>25</sup> / <sub>64</sub>	1 <sup>1</sup> / <sub>32</sub>	1 <sup>27</sup> / <sub>64</sub>	3.9370	2 <sup>1</sup> / <sub>64</sub>	1.9370	0.748	7/16
1 9/16	UCFC208-109D1													
45	UCFC209D1	160	132	93.3	10	16	12	26	38	105	52.2	49.2	19	M14
1 5/8	UCFC209-110D1													
1 11/16	UCFC209-111D1	6 <sup>5</sup> / <sub>16</sub>	5 <sup>13</sup> / <sub>64</sub>	3 <sup>43</sup> / <sub>64</sub>	25 <sup>25</sup> / <sub>64</sub>	5 <sup>5</sup> / <sub>16</sub>	15 <sup>15</sup> / <sub>32</sub>	1 <sup>1</sup> / <sub>32</sub>	1 <sup>1</sup> / <sub>2</sub>	4.1339	2 <sup>3</sup> / <sub>64</sub>	1.9370	0.748	1/2
1 3/4	UCFC209-112D1													

Note (1) These numbers indicate relubricatable type. If maintenance free type is needed, please order without suffix "D1".

Remarks Please refer to page A21 for size of grease fitting.

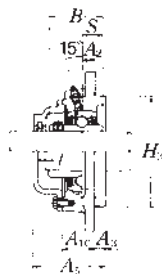
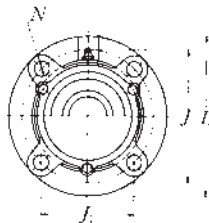
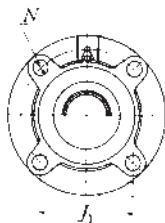

**Pressed steel dust cover type**

Open end **Z-UCFC...D1**

Closed end **ZM-UCFC...D1**

**Cast dust cover type**

Open end **C-UCFC...D1**

Closed end **CM-UCFC...D1**

Bearing number	Housing number	Unit number (1) pressed steel dust cover type	Unit number (1) cast dust cover type	Nominal dimensions				Mass of unit		
				mm inch				kg lb		
				<i>t</i>	<i>A</i> <sub>4</sub>	<i>A</i> <sub>1C</sub>	<i>A</i> <sub>5</sub>	UCFC	Z(ZM)	C(CM)
				max.						
UC201D1	FC204D1	Z(ZM)-UCFC201D1	C(CM)-UCFC201D1	2	38	20.5	46	0.8	0.8	0.9
UC201-008D1	FC204D1	Z(ZM)-UCFC201-008D1	C(CM)-UCFC201-008D1	5/64	1 1/2	13/16	1 13/16	1.8	1.8	2.0
UC202D1	FC204D1	Z(ZM)-UCFC202D1	C(CM)-UCFC202D1	2	38	20.5	46	0.8	0.8	0.9
UC202-009D1	FC204D1	Z(ZM)-UCFC202-009D1	C(CM)-UCFC202-009D1	5/64	1 1/2	13/16	1 13/16	1.8	1.8	2.0
UC202-010D1	FC204D1	Z(ZM)-UCFC202-010D1	C(CM)-UCFC202-010D1	5/64	1 1/2	13/16	1 13/16	1.8	1.8	2.0
UC203D1	FC204D1	Z(ZM)-UCFC203D1	C(CM)-UCFC203D1	2	38	20.5	46	0.8	0.8	0.9
UC203-011D1	FC204D1	Z(ZM)-UCFC203-011D1	C(CM)-UCFC203-011D1	5/64	1 1/2	13/16	1 13/16	1.8	1.8	2.0
UC204D1	FC204D1	Z(ZM)-UCFC204D1	C(CM)-UCFC204D1	2	38	20.5	46	0.7	0.7	0.9
UC204-012D1	FC204D1	Z(ZM)-UCFC204-012D1	C(CM)-UCFC204-012D1	5/64	1 1/2	13/16	1 13/16	1.5	1.5	2.0
UC205D1	FC205D1	Z(ZM)-UCFC205D1	C(CM)-UCFC205D1	2	40	22	51	1.0	1.0	1.2
UC205-013D1	FC205D1	Z(ZM)-UCFC205-013D1	C(CM)-UCFC205-013D1	5/64	1 19/32	7/8	2	2.2	2.2	2.6
UC205-014D1	FC205D1	Z(ZM)-UCFC205-014D1	C(CM)-UCFC205-014D1	5/64	1 19/32	7/8	2	2.2	2.2	2.6
UC205-015D1	FC205D1	Z(ZM)-UCFC205-015D1	C(CM)-UCFC205-015D1	5/64	1 19/32	7/8	2	2.2	2.2	2.6
UC205-100D1	FC205D1	Z(ZM)-UCFC205-100D1	C(CM)-UCFC205-100D1	5/64	1 19/32	7/8	2	2.2	2.2	2.6
UC206D1	FC206D1	Z(ZM)-UCFC206D1	C(CM)-UCFC206D1	2	45	24.5	56	1.3	1.4	1.6
UC206-101D1	FC206D1	Z(ZM)-UCFC206-101D1	C(CM)-UCFC206-101D1	5/64	1 3/4	31/32	2 13/64	2.9	3.1	3.5
UC206-102D1	FC206D1	Z(ZM)-UCFC206-102D1	C(CM)-UCFC206-102D1	5/64	1 3/4	31/32	2 13/64	2.9	3.1	3.5
UC206-103D1	FC206D1	Z(ZM)-UCFC206-103D1	C(CM)-UCFC206-103D1	5/64	1 3/4	31/32	2 13/64	2.9	3.1	3.5
UC206-104D1	FC206D1	—	C(CM)-UCFC206-104D1	5/64	1 3/4	31/32	2 13/64	2.9	3.1	3.5
UC207D1	FC207D1	Z(ZM)-UCFC207D1	C(CM)-UCFC207D1	3	49	26	59	1.6	1.7	1.9
UC207-104D1	FC207D1	Z(ZM)-UCFC207-104D1	C(CM)-UCFC207-104D1	1/8	1 15/16	1 1/32	2 21/64	3.5	3.7	4.2
UC207-105D1	FC207D1	Z(ZM)-UCFC207-105D1	C(CM)-UCFC207-105D1	1/8	1 15/16	1 1/32	2 21/64	3.5	3.7	4.2
UC207-106D1	FC207D1	Z(ZM)-UCFC207-106D1	C(CM)-UCFC207-106D1	1/8	1 15/16	1 1/32	2 21/64	3.5	3.7	4.2
UC207-107D1	FC207D1	—	C(CM)-UCFC207-107D1	1/8	1 15/16	1 1/32	2 21/64	3.5	3.7	4.2
UC208D1	FC208D1	Z(ZM)-UCFC208D1	C(CM)-UCFC208D1	3	56	27.5	66	2.0	2.1	2.4
UC208-108D1	FC208D1	Z(ZM)-UCFC208-108D1	C(CM)-UCFC208-108D1	1/8	2 3/16	1 5/8	2 19/32	4.4	4.6	5.3
UC208-109D1	FC208D1	Z(ZM)-UCFC208-109D1	C(CM)-UCFC208-109D1	1/8	2 3/16	1 5/8	2 19/32	4.4	4.6	5.3
UC209D1	FC209D1	Z(ZM)-UCFC209D1	C(CM)-UCFC209D1	3	57	28	70	2.7	2.7	3.2
UC209-110D1	FC209D1	Z(ZM)-UCFC209-110D1	C(CM)-UCFC209-110D1	1/8	2 1/4	1 1/4	2 3/4	6.0	6.0	7.1
UC209-111D1	FC209D1	Z(ZM)-UCFC209-111D1	C(CM)-UCFC209-111D1	1/8	2 1/4	1 1/4	2 3/4	6.0	6.0	7.1
UC209-112D1	FC209D1	Z(ZM)-UCFC209-112D1	C(CM)-UCFC209-112D1	1/8	2 1/4	1 1/4	2 3/4	6.0	6.0	7.1

## Round flanged unit, cast housing with spigot joint Set screw type

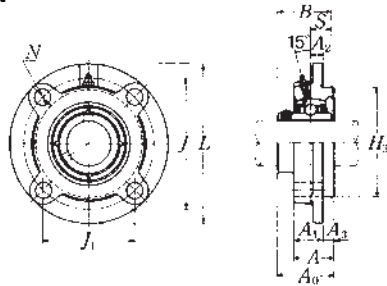

Shaft dia. mm inch	Unit number (1)	Nominal dimensions											Bolt size mm inch	
		mm inch												
		L	J	(J <sub>1</sub> )	A <sub>2</sub>	N	A <sub>3</sub>	A <sub>1</sub>	A	H <sub>3</sub>	A <sub>0</sub>	B	S	
50	<b>UCFC210D1</b>	165	138	97.6	10	16	12	28	40	110	54.6	51.6	19	M14
1 <sup>13</sup> / <sub>16</sub>	<b>UCFC210-113D1</b>													
1 <sup>7</sup> / <sub>8</sub>	<b>UCFC210-114D1</b>	6 <sup>1</sup> / <sub>2</sub>	5 <sup>7</sup> / <sub>16</sub>	3 <sup>27</sup> / <sub>32</sub>	<sup>25</sup> / <sub>64</sub>	<sup>5</sup> / <sub>8</sub>	<sup>15</sup> / <sub>32</sub>	1 <sup>3</sup> / <sub>32</sub>	1 <sup>37</sup> / <sub>64</sub>	4.3307	2 <sup>5</sup> / <sub>32</sub>	2.0315	0.748	<sup>1</sup> / <sub>2</sub>
1 <sup>15</sup> / <sub>16</sub>	<b>UCFC210-115D1</b>													
2	<b>UCFC210-200D1</b>													
55	<b>UCFC211D1</b>	185	150	106.1	13	19	12	31	43	125	58.4	55.6	22.2	M16
2	<b>UCFC211-200D1</b>													
2 <sup>1</sup> / <sub>16</sub>	<b>UCFC211-201D1</b>	7 <sup>9</sup> / <sub>32</sub>	5 <sup>29</sup> / <sub>32</sub>	4 <sup>11</sup> / <sub>64</sub>	<sup>33</sup> / <sub>64</sub>	<sup>3</sup> / <sub>4</sub>	<sup>15</sup> / <sub>32</sub>	1 <sup>7</sup> / <sub>32</sub>	1 <sup>11</sup> / <sub>16</sub>	4.9213	2 <sup>19</sup> / <sub>64</sub>	2.1890	0.874	<sup>5</sup> / <sub>8</sub>
2 <sup>1</sup> / <sub>8</sub>	<b>UCFC211-202D1</b>													
2 <sup>3</sup> / <sub>16</sub>	<b>UCFC211-203D1</b>													
60	<b>UCFC212D1</b>	195	160	113.1	17	19	12	36	48	135	68.7	65.1	25.4	M16
2 <sup>1</sup> / <sub>4</sub>	<b>UCFC212-204D1</b>													
2 <sup>5</sup> / <sub>16</sub>	<b>UCFC212-205D1</b>	7 <sup>11</sup> / <sub>16</sub>	6 <sup>19</sup> / <sub>64</sub>	4 <sup>29</sup> / <sub>64</sub>	<sup>43</sup> / <sub>64</sub>	<sup>3</sup> / <sub>4</sub>	<sup>15</sup> / <sub>32</sub>	1 <sup>13</sup> / <sub>32</sub>	1 <sup>57</sup> / <sub>64</sub>	5.3150	2 <sup>45</sup> / <sub>64</sub>	2.5630	1.000	<sup>5</sup> / <sub>8</sub>
2 <sup>3</sup> / <sub>8</sub>	<b>UCFC212-206D1</b>													
2 <sup>7</sup> / <sub>16</sub>	<b>UCFC212-207D1</b>													
65	<b>UCFC213D1</b>	205	170	120.2	16	19	14	36	50	145	69.7	65.1	25.4	M16
2 <sup>1</sup> / <sub>2</sub>	<b>UCFC213-208D1</b>	8 <sup>1</sup> / <sub>16</sub>	6 <sup>11</sup> / <sub>16</sub>	4 <sup>47</sup> / <sub>64</sub>	<sup>5</sup> / <sub>8</sub>	<sup>3</sup> / <sub>4</sub>	<sup>35</sup> / <sub>64</sub>	1 <sup>13</sup> / <sub>32</sub>	1 <sup>31</sup> / <sub>32</sub>	5.7087	2 <sup>3</sup> / <sub>4</sub>	2.5630	1.000	<sup>5</sup> / <sub>8</sub>
2 <sup>9</sup> / <sub>16</sub>	<b>UCFC213-209D1</b>													
70	<b>UCFC214D1</b>	215	177	125.2	17	19	14	40	54	150	75.4	74.6	30.2	M16
2 <sup>5</sup> / <sub>8</sub>	<b>UCFC214-210D1</b>													
2 <sup>11</sup> / <sub>16</sub>	<b>UCFC214-211D1</b>	8 <sup>15</sup> / <sub>32</sub>	6 <sup>31</sup> / <sub>32</sub>	4 <sup>59</sup> / <sub>64</sub>	<sup>43</sup> / <sub>64</sub>	<sup>3</sup> / <sub>4</sub>	<sup>35</sup> / <sub>64</sub>	1 <sup>37</sup> / <sub>64</sub>	2 <sup>1</sup> / <sub>8</sub>	5.9055	2 <sup>31</sup> / <sub>32</sub>	2.9370	1.189	<sup>5</sup> / <sub>8</sub>
2 <sup>3</sup> / <sub>4</sub>	<b>UCFC214-212D1</b>													
75	<b>UCFC215D1</b>	220	184	130.1	18	19	16	40	56	160	78.5	77.8	33.3	M16
2 <sup>13</sup> / <sub>16</sub>	<b>UCFC215-213D1</b>													
2 <sup>7</sup> / <sub>8</sub>	<b>UCFC215-214D1</b>	8 <sup>21</sup> / <sub>32</sub>	7 <sup>1</sup> / <sub>4</sub>	5 <sup>1</sup> / <sub>8</sub>	<sup>45</sup> / <sub>64</sub>	<sup>3</sup> / <sub>4</sub>	<sup>5</sup> / <sub>8</sub>	1 <sup>37</sup> / <sub>64</sub>	2 <sup>13</sup> / <sub>64</sub>	6.2992	3 <sup>3</sup> / <sub>32</sub>	3.0630	1.311	<sup>5</sup> / <sub>8</sub>
2 <sup>15</sup> / <sub>16</sub>	<b>UCFC215-215D1</b>													
3	<b>UCFC215-300D1</b>													
80	<b>UCFC216D1</b>	240	200	141.4	18	23	16	42	58	170	83.3	82.6	33.3	M20
3 <sup>1</sup> / <sub>16</sub>	<b>UCFC216-301D1</b>													
3 <sup>1</sup> / <sub>8</sub>	<b>UCFC216-302D1</b>	9 <sup>7</sup> / <sub>16</sub>	7 <sup>7</sup> / <sub>8</sub>	5 <sup>9</sup> / <sub>16</sub>	<sup>45</sup> / <sub>64</sub>	<sup>29</sup> / <sub>32</sub>	<sup>5</sup> / <sub>8</sub>	1 <sup>21</sup> / <sub>32</sub>	2 <sup>9</sup> / <sub>32</sub>	6.6929	3 <sup>9</sup> / <sub>32</sub>	3.2520	1.311	<sup>3</sup> / <sub>4</sub>
3 <sup>3</sup> / <sub>16</sub>	<b>UCFC216-303D1</b>													

Note (1) These numbers indicate relubricatable type. If maintenance free type is needed, please order without suffix "D1".

Remarks Please refer to page A21 for size of grease fitting.

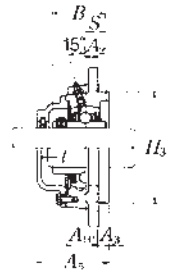
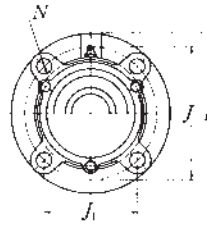
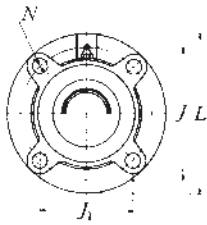

**Pressed steel dust cover type**

Open end **Z-UCFC...D1**  
 Closed end **ZM-UCFC...D1**

**Cast dust cover type**

Open end **C-UCFC...D1**  
 Closed end **CM-UCFC...D1**

Bearing number	Housing number	Unit number (1) pressed steel dust cover type	Unit number (1) cast dust cover type	Nominal dimensions				Mass of unit		
				t max.	mm	inch	A <sub>4</sub>	A <sub>1C</sub>	A <sub>5</sub>	kg
UC210D1	FC210D1	<b>Z(ZM)-UCFC210D1</b>	<b>C(CM)-UCFC210D1</b>	3	60	29	72	3.0	3.1	3.6
UC210-113D1	FC210D1	<b>Z(ZM)-UCFC210-113D1</b>	<b>C(CM)-UCFC210-113D1</b>							
UC210-114D1	FC210D1	<b>Z(ZM)-UCFC210-114D1</b>	<b>C(CM)-UCFC210-114D1</b>							
UC210-115D1	FC210D1	<b>Z(ZM)-UCFC210-115D1</b>	<b>C(CM)-UCFC210-115D1</b>	1/8	2 3/8	1 1/2	2 59/64	6.6	6.8	7.9
UC210-200D1	FC210D1	—	<b>C(CM)-UCFC210-200D1</b>							
UC211D1	FC211D1	<b>Z(ZM)-UCFC211D1</b>	<b>C(CM)-UCFC211D1</b>	4	64	32.5	75	4.1	4.2	4.8
UC211-200D1	FC211D1	<b>Z(ZM)-UCFC211-200D1</b>	<b>C(CM)-UCFC211-200D1</b>							
UC211-201D1	FC211D1	<b>Z(ZM)-UCFC211-201D1</b>	<b>C(CM)-UCFC211-201D1</b>							
UC211-202D1	FC211D1	<b>Z(ZM)-UCFC211-202D1</b>	<b>C(CM)-UCFC211-202D1</b>	5/32	2 1/2	1 1/2	2 61/64	9.0	9.3	11
UC211-203D1	FC211D1	<b>Z(ZM)-UCFC211-203D1</b>	<b>C(CM)-UCFC211-203D1</b>							
UC212D1	FC212D1	<b>Z(ZM)-UCFC212D1</b>	<b>C(CM)-UCFC212D1</b>	4	74	38	86	4.9	5.1	5.9
UC212-204D1	FC212D1	<b>Z(ZM)-UCFC212-204D1</b>	<b>C(CM)-UCFC212-204D1</b>							
UC212-205D1	FC212D1	<b>Z(ZM)-UCFC212-205D1</b>	<b>C(CM)-UCFC212-205D1</b>							
UC212-206D1	FC212D1	<b>Z(ZM)-UCFC212-206D1</b>	<b>C(CM)-UCFC212-206D1</b>	5/32	2 29/32	1 1/2	3 25/64	11	11	13
UC212-207D1	FC212D1	—	<b>C(CM)-UCFC212-207D1</b>							
UC213D1	FC213D1	<b>Z(ZM)-UCFC213D1</b>	<b>C(CM)-UCFC213D1</b>	4	76	38	89.5	5.8	6.0	6.8
UC213-208D1	FC213D1	<b>Z(ZM)-UCFC213-208D1</b>	<b>C(CM)-UCFC213-208D1</b>							
UC213-209D1	FC213D1	<b>Z(ZM)-UCFC213-209D1</b>	<b>C(CM)-UCFC213-209D1</b>	5/32	3	1 1/2	3 17/32	13	13	15
UC214D1	FC214D1	—	<b>C(CM)-UCFC214D1</b>	4	—	39.5	98	7.0	—	8.0
UC214-210D1	FC214D1	—	<b>C(CM)-UCFC214-210D1</b>							
UC214-211D1	FC214D1	—	<b>C(CM)-UCFC214-211D1</b>	5/32	—	1 9/16	3 55/64	15	—	18
UC214-212D1	FC214D1	—	<b>C(CM)-UCFC214-212D1</b>							
UC215D1	FC215D1	—	<b>C(CM)-UCFC215D1</b>	4	—	43	102	7.4	—	8.8
UC215-213D1	FC215D1	—	<b>C(CM)-UCFC215-213D1</b>							
UC215-214D1	FC215D1	—	<b>C(CM)-UCFC215-214D1</b>							
UC215-215D1	FC215D1	—	<b>C(CM)-UCFC215-215D1</b>	5/32	—	1 11/16	4 1/64	16	—	19
UC215-300D1	FC215D1	—	<b>C(CM)-UCFC215-300D1</b>							
UC216D1	FC216D1	—	<b>C(CM)-UCFC216D1</b>	4	—	43	106	9.1	—	10
UC216-301D1	FC216D1	—	<b>C(CM)-UCFC216-301D1</b>							
UC216-302D1	FC216D1	—	<b>C(CM)-UCFC216-302D1</b>	5/32	—	1 11/16	4 11/64	20	—	22
UC216-303D1	FC216D1	—	<b>C(CM)-UCFC216-303D1</b>							

## Round flanged unit, cast housing with spigot joint Set screw type

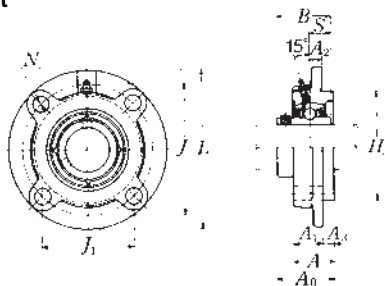

Shaft dia. mm inch	Unit number <sup>(1)</sup>	Nominal dimensions											Bolt size mm inch	
		<i>L</i>	<i>J</i>	<i>(J<sub>1</sub>)</i>	<i>A<sub>2</sub></i>	<i>N</i>	<i>A<sub>3</sub></i>	<i>A<sub>1</sub></i>	<i>A</i>	<i>H<sub>3</sub></i>	<i>A<sub>0</sub></i>	<i>B</i>		<i>S</i>
85 3 1/4	<b>UCFC217D1</b>	250	208	147.1	18	23	18	45	63	180	87.6	85.7	34.1	M20
3 5/16	<b>UCFC217-304D1</b>	9 27/32	8 3/16	5 51/64	45/64	29/32	45/64	1 25/32	2 31/64	7.0866	3 29/64	3.3740	1.343	3/4
3 7/16	<b>UCFC217-307D1</b>													
90 3 1/2	<b>UCFC218D1</b>	265	220	155.6	22	23	18	50	68	190	96.3	96	39.7	M20
	<b>UCFC218-308D1</b>	10 7/16	8 21/32	6 1/8	55/64	29/32	45/64	1 31/32	2 43/64	7.4803	3 51/64	3.7795	1.563	3/4

**Note** <sup>(1)</sup> These numbers indicate relubricatable type. If maintenance free type is needed, please order without suffix "D1".

**Remarks** Please refer to page **A21** for size of grease fitting.

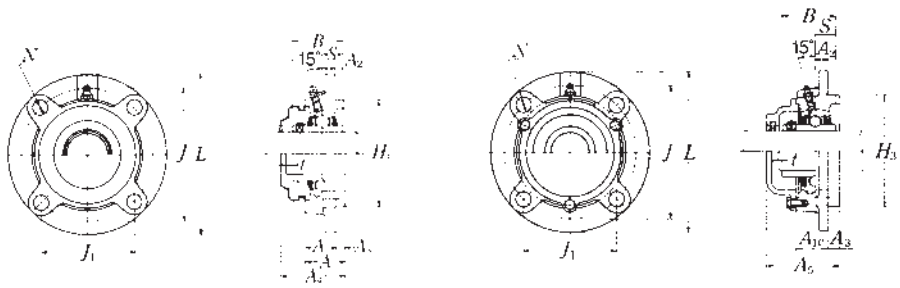

**Pressed steel dust cover type**

Open end **Z-UCFC...D1**

Closed end **ZM-UCFC...D1**

**Cast dust cover type**

Open end **C-UCFC...D1**

Closed end **CM-UCFC...D1**

Bearing number	Housing number	Unit number (*) pressed steel dust cover type	Unit number (*) cast dust cover type	Nominal deimensions				Mass of unit		
				t max.	A <sub>4</sub>	A <sub>1C</sub>	A <sub>5</sub>	UCFC	Z(ZM)	C(CM)
UC217D1	FC217D1	—	<b>C(CM)-UCFC217D1</b>	5	—	45.5	114	11	—	12
UC217-304D1	FC217D1	—	<b>C(CM)-UCFC217-304D1</b>	$\frac{13}{64}$	—	$1\frac{51}{64}$	$4\frac{31}{64}$	24	—	26
UC217-305D1	FC217D1		<b>C(CM)-UCFC217-305D1</b>							
UC217-307D1	FC217D1		<b>C(CM)-UCFC217-307D1</b>							
UC218D1	FC218D1	—	<b>C(CM)-UCFC218D1</b>	5	—	50	122	13	—	15
UC218-308D1	FC218D1	—	<b>C(CM)-UCFC218-308D1</b>	$\frac{19}{64}$	—	$1\frac{31}{32}$	$4\frac{51}{64}$	29	—	33

## Round flanged unit, cast housing with spigot joint Set screw type

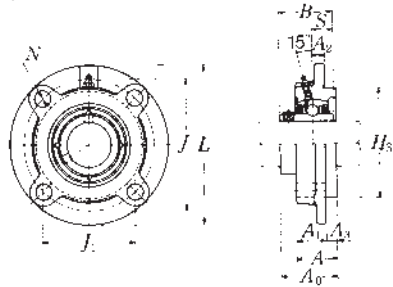

Shaft dia. mm inch	Unit number (1)	Nominal dimensions												Bolt size mm inch
		mm inch												
		L	J	(J <sub>1</sub> )	A <sub>2</sub>	N	A <sub>3</sub>	A <sub>1</sub>	A	H <sub>3</sub>	A <sub>0</sub>	B	S	
25 1 3/16	UCFCX05D1	111	92	65.1	10	9.5	6	24	30	76	38.2	38.1	15.9	M8
7/8 15/16	UCFCX05-013D1													
	UCFCX05-014D1	4 3/8	3 5/8	2 9/16	25/64	3/8	1/4	15/16	1 3/16	2.9921	1 1/2	1.5000	0.626	5/16
	UCFCX05-015D1													
1	UCFCX05-100D1													
30 1 1/16	UCFCX06D1	127	105	74.2	8	12	9.5	22.5	32	85	42.9	42.9	17.5	M10
1 1/8	UCFCX06-101D1													
1 3/16	UCFCX06-102D1	5	4 3/64	2 59/64	5/16	15/32	3/8	7/8	1 27/64	3.3465	1 11/16	1.6890	0.689	3/8
1 3/4	UCFCX06-103D1													
	UCFCX06-104D1													
35 1 5/16	UCFCX07D1	133	111	78.5	9	12	11	26	37	92	50.2	49.2	19	M10
1 3/8	UCFCX07-105D1													
1 7/16	UCFCX07-106D1	5 1/4	4 3/8	3 3/32	23/64	15/32	7/16	1 1/32	1 29/64	3.6220	1 31/32	1.9370	0.748	3/8
	UCFCX07-107D1													
40 1 1/2	UCFCX08D1	133	111	78.5	9	12	11	26	37	92	50.2	49.2	19	M10
1 9/16	UCFCX08-108D1													
	UCFCX08-109D1	5 1/4	4 3/8	3 3/32	23/64	15/32	7/16	1 1/32	1 29/64	3.6220	1 31/32	1.9370	0.748	3/8
45 1 5/8	UCFCX09D1	155	130	91.9	8	14	12	25	37	108	52.6	51.6	19	M12
1 11/16	UCFCX09-110D1													
1 3/4	UCFCX09-111D1	6 3/32	5 1/8	3 5/8	5/16	35/64	15/32	31/32	1 29/64	4.2520	2 5/64	2.0315	0.748	7/16
1 13/16	UCFCX09-112D1													
	UCFCX09-113D1													
50 1 7/8	UCFCX10D1	162	136	96.2	7	14	16	25	41	118	56.4	55.6	22.2	M12
1 15/16	UCFCX10-114D1													
2	UCFCX10-115D1	6 3/8	5 23/64	3 25/32	9/32	35/64	5/8	31/32	1 39/64	4.6457	2 7/32	2.1890	0.874	7/16
	UCFCX10-200D1													

Note (1) These numbers indicate relubricatable type. If maintenance free type is needed, please order without suffix "D1".

Remarks Please refer to page A21 for size of grease fitting.

Bearing number	Housing (*) number	Mass of unit
		kg lb
UCX05D1	FCX05D1	1.2
UCX05-013D1	FCX05D1	2.6
UCX05-014D1	FCX05D1	
UCX05-015D1	FCX05D1	
UCX05-100D1	FCX05D1	
UCX06D1	FCX06D1	1.7
UCX06-101D1	FCX06D1	3.7
UCX06-102D1	FCX06D1	
UCX06-103D1	FCX06D1	
UC207-104D1	FCX06D1	
UCX07D1	FCX07D1	1.9
UCX07-105D1	FCX07D1	4.2
UCX07-106D1	FCX07D1	
UCX07-107D1	FCX07D1	
UCX08D1	FCX08D1	2.0
UCX08-108D1	FCX08D1	4.4
UCX08-109D1	FCX08D1	
UCX09D1	FCX09D1	2.6
UCX09-110D1	FCX09D1	5.7
UCX09-111D1	FCX09D1	
UCX09-112D1	FCX09D1	
UC210-113D1	FCX09D1	
UCX10D1	FCX10D1	3.1
UCX10-114D1	FCX10D1	6.8
UCX10-115D1	FCX10D1	
UC211-200D1	FCX10D1	



## Round flanged unit, cast housing with spigot joint Set screw type

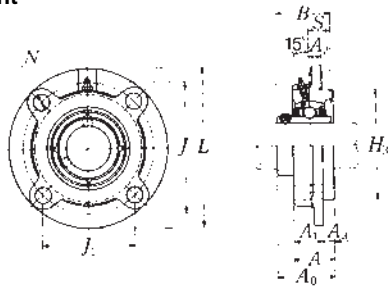

Shaft dia. mm inch	Unit number (1)	Nominal dimensions											Bolt size mm inch	
		mm inch												
		L	J	(J <sub>1</sub> )	A <sub>2</sub>	N	A <sub>3</sub>	A <sub>1</sub>	A	H <sub>3</sub>	A <sub>0</sub>	B	S	
55 2 1/16 2 1/8	<b>UCFCX11D1</b> <b>UCFCX11-201D1</b> <b>UCFCX11-202D1</b>	180	152	107.5	4	16	22	26	48	127	65.7	65.1	25.4	M14
2 3/16 2 1/4 2 5/16	<b>UCFCX11-203D1</b> <b>UCFCX11-204D1</b> <b>UCFCX11-205D1</b>	7 3/32	5 53/64	4 15/64	5/32	5/8	55/64	1 1/32	1 57/64	5.0000	2 19/32	2.5630	1.000	1/2
60 2 3/8 2 7/16	<b>UCFCX12D1</b> <b>UCFCX12-206D1</b> <b>UCFCX12-207D1</b>	194	165	116.7	11	16	20	33	53	140	70.7	65.1	25.4	M14
		7 5/8	6 1/2	4 19/32	7/16	5/8	25/32	1 5/16	2 5/64	5.5118	2 25/32	2.5630	1.000	1/2
65 2 1/2 2 9/16	<b>UCFCX13D1</b> <b>UCFCX13-208D1</b> <b>UCFCX13-209D1</b>	194	165	116.7	11	16	20	33	53	140	75.4	74.6	30.2	M14
		7 5/8	6 1/2	4 19/32	7/16	5/8	25/32	1 5/16	2 5/64	5.5118	2 31/32	2.9370	1.189	1/2
70 2 5/8 2 11/16 2 3/4	<b>UCFCX14D1</b> <b>UCFCX14-210D1</b> <b>UCFCX14-211D1</b> <b>UCFCX14-212D1</b>	222	190	134.4	14	19	20	36	56	164	78.5	77.8	33.3	M16
		8 3/4	7 31/64	5 9/32	35/64	3/4	25/32	1 13/32	2 13/64	6.4567	3 3/32	3.0630	1.311	5/8
75 2 13/16 2 7/8 2 15/16 3	<b>UCFCX15D1</b> <b>UCFCX15-213D1</b> <b>UCFCX15-214D1</b> <b>UCFCX15-215D1</b> <b>UCFCX15-300D1</b>	222	190	134.4	12	19	22	35	57	164	83.3	82.6	33.3	M16
		8 3/4	7 31/64	5 9/32	15/32	3/4	55/64	1 3/8	2 1/4	6.4567	3 3/32	3.2520	1.311	5/8
80 3 1/16 3 3/8 3 3/16 3 1/4	<b>UCFCX16D1</b> <b>UCFCX16-301D1</b> <b>UCFCX16-302D1</b> <b>UCFCX16-303D1</b> <b>UCFCX16-304D1</b>	260	219	154.9	10	23	25	36	61	186	86.6	85.7	34.1	M20
		10 1/4	8 5/8	6 3/32	25/64	29/32	63/64	1 13/32	2 13/32	7.3228	3 13/32	3.3740	1.343	3/4
85 3 5/16 3 7/16	<b>UCFCX17D1</b> <b>UCFCX17-305D1</b> <b>UCFCX17-307D1</b>	260	219	154.9	10	23	25	36	61	186	91.3	96	39.7	M20
		10 1/4	8 5/8	6 3/32	25/64	29/32	63/64	1 13/32	2 13/32	7.3228	3 19/32	3.7795	1.563	3/4

Note (1) These numbers indicate relubricatable type. If maintenance free type is needed, please order without suffix "D1".

Remarks Please refer to page A21 for size of grease fitting.

Bearing number	Housing <sup>(1)</sup> number	Mass of unit
		kg lb
UCX11D1	FCX11D1	4.2
UCX11-201D1	FCX11D1	9.3
UCX11-202D1	FCX11D1	
UCX11-203D1	FCX11D1	
UC212-204D1	FCX11D1	
UC212-205D1	FCX11D1	
UCX12D1	FCX12D1	5.5
UCX12-206D1	FCX12D1	12
UCX12-207D1	FCX12D1	
UCX13D1	FCX13D1	5.7
UCX13-208D1	FCX13D1	13
UCX13-209D1	FCX13D1	
UCX14D1	FCX14D1	7.3
UCX14-210D1	FCX14D1	16
UCX14-211D1	FCX14D1	
UCX14-212D1	FCX14D1	
UCX15D1	FCX15D1	8.0
UCX15-213D1	FCX15D1	18
UCX15-214D1	FCX15D1	
UCX15-215D1	FCX15D1	
UCX15-300D1	FCX15D1	
UCX16D1	FCX16D1	12
UCX16-301D1	FCX16D1	26
UCX16-302D1	FCX16D1	
UCX16-303D1	FCX16D1	
UC217-304D1	FCX16D1	
UCX17D1	FCX17D1	12
UCX17-305D1	FCX17D1	26
UCX17-307D1	FCX17D1	

## Round flanged unit, cast housing with spigot joint Set screw type

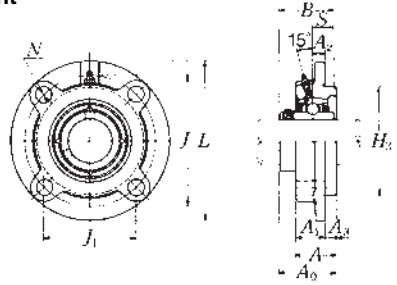

Shaft dia. mm inch	Unit number (1)	Nominal dimensions											Bolt size mm inch	
		mm inch												
		L	J	(J <sub>1</sub> )	A <sub>2</sub>	N	A <sub>3</sub>	A <sub>1</sub>	A	H <sub>3</sub>	A <sub>0</sub>	B	S	
90 3 <sup>7</sup> / <sub>16</sub> 3 <sup>1</sup> / <sub>2</sub>	<b>UCFCX18D1</b> <b>UCFCX18-307D1</b> <b>UCFCX18-308D1</b>	260 10 <sup>1</sup> / <sub>4</sub>	219 8 <sup>5</sup> / <sub>8</sub>	154.9 6 <sup>3</sup> / <sub>32</sub>	12 15 <sup>1</sup> / <sub>32</sub>	23 29 <sup>29</sup> / <sub>32</sub>	28 1 <sup>7</sup> / <sub>64</sub>	43 1 <sup>11</sup> / <sub>16</sub>	71 2 <sup>61</sup> / <sub>64</sub>	186 7.3228	101.1 3 <sup>63</sup> / <sub>64</sub>	104 4.0945	42.9 1.689	M20 3/4
100 3 <sup>13</sup> / <sub>16</sub> 3 <sup>7</sup> / <sub>8</sub> 3 <sup>15</sup> / <sub>16</sub> 4	<b>UCFCX20D1</b> <b>UCFCX20-313D1</b> <b>UCFCX20-314D1</b> <b>UCFCX20-315D1</b> <b>UCFCX20-400D1</b>	276 10 <sup>7</sup> / <sub>8</sub>	238 9 <sup>3</sup> / <sub>8</sub>	168.3 6 <sup>5</sup> / <sub>8</sub>	22 55 <sup>55</sup> / <sub>64</sub>	23 29 <sup>29</sup> / <sub>32</sub>	28 1 <sup>7</sup> / <sub>64</sub>	66 2 <sup>19</sup> / <sub>32</sub>	94 3 <sup>45</sup> / <sub>64</sub>	206 8.1102	118.3 4 <sup>21</sup> / <sub>32</sub>	117.5 4.6260	49.2 1.937	M20 3/4

**Note** (1) These numbers indicate relubricatable type. If maintenance free type is needed, please order without suffix "D1".

**Remarks** Please refer to page A21 for size of grease fitting.

Bearing number	Housing (*) number	Mass of unit
		kg lb
UCX18D1	FCX18D1	12
UCX18-307D1	FCX18D1	26
UCX18-308D1	FCX18D1	
UCX20D1	FCX20D1	18
UCX20-313D1	FCX20D1	40
UCX20-314D1	FCX20D1	
UCX20-315D1	FCX20D1	
UCX20-400D1	FCX20D1	

## Rhombus flanged unit, cast housing Set screw type

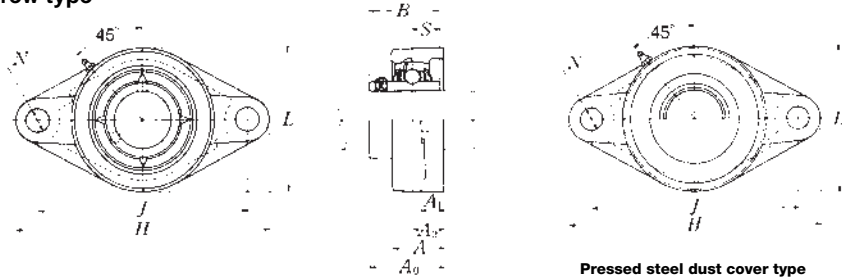

Pressed steel dust cover type  
Open end **Z-UCFL...D1**  
Closed end **ZM-UCFL...D1**

Shaft dia. mm inch	Unit number (1)	Nominal dimensions										Bolt size mm inch	Bearing number
		mm inch											
		H	J	A <sub>2</sub>	A <sub>1</sub>	A	N	L	A <sub>0</sub>	B	S		
12	<b>UCFL201D1</b>	113	90	15	11	25.5	12	60	33.3	31	12.7	M10	UC201D1
1/2	<b>UCFL201-008D1</b>	4 7/16	3 35/64	19/32	7/16	1	15/32	2 3/8	1 5/16	1.2205	0.500	3/8	UC201-008D1
15	<b>UCFL202D1</b>	113	90	15	11	25.5	12	60	33.3	31	12.7	M10	UC202D1
9/16	<b>UCFL202-009D1</b>	4 7/16	3 35/64	19/32	7/16	1	15/32	2 3/8	1 5/16	1.2205	0.500	3/8	UC202-009D1
5/8	<b>UCFL202-010D1</b>												UC202-010D1
17	<b>UCFL203D1</b>	113	90	15	11	25.5	12	60	33.3	31	12.7	M10	UC203D1
1 1/16	<b>UCFL203-011D1</b>	4 7/16	3 35/64	19/32	7/16	1	15/32	2 3/8	1 5/16	1.2205	0.500	3/8	UC203-011D1
20	<b>UCFL204D1</b>	113	90	15	11	25.5	12	60	33.3	31	12.7	M10	UC204D1
3/4	<b>UCFL204-012D1</b>	4 7/16	3 35/64	19/32	7/16	1	15/32	2 3/8	1 5/16	1.2205	0.500	3/8	UC204-012D1
25	<b>UCFL205D1</b>	130	99	16	13	27	16	68	35.8	34.1	14.3	M14	UC205D1
1 3/16	<b>UCFL205-013D1</b>												UC205-013D1
7/8	<b>UCFL205-014D1</b>												UC205-014D1
1 5/16	<b>UCFL205-015D1</b>	5 1/8	3 57/64	5/8	1/2	1 1/16	5/8	2 11/16	1 13/32	1.3425	0.563	1/2	UC205-015D1
1	<b>UCFL205-100D1</b>												UC205-100D1
30	<b>UCFL206D1</b>	148	117	18	13	31	16	80	40.2	38.1	15.9	M14	UC206D1
1 1/16	<b>UCFL206-101D1</b>												UC206-101D1
1 1/8	<b>UCFL206-102D1</b>	5 13/16	4 39/64	45/64	1/2	1 7/32	5/8	3 5/32	1 37/64	1.5000	0.626	1/2	UC206-102D1
1 3/16	<b>UCFL206-103D1</b>												UC206-103D1
1 1/4	<b>UCFL206-104D1</b>												UC206-104D1
35	<b>UCFL207D1</b>	161	130	19	15	34	16	90	44.4	42.9	17.5	M14	UC207D1
1 1/4	<b>UCFL207-104D1</b>												UC207-104D1
1 5/16	<b>UCFL207-105D1</b>	6 11/32	5 1/8	3/4	19/32	1 11/32	5/8	3 17/32	1 3/4	1.6890	0.689	1/2	UC207-105D1
1 3/8	<b>UCFL207-106D1</b>												UC207-106D1
1 7/16	<b>UCFL207-107D1</b>												UC207-107D1
40	<b>UCFL208D1</b>	175	144	21	15	36	16	100	51.2	49.2	19	M14	UC208D1
1 1/2	<b>UCFL208-108D1</b>												UC208-108D1
1 9/16	<b>UCFL208-109D1</b>	6 7/8	5 43/64	53/64	19/32	1 13/32	5/8	3 15/16	2 1/64	1.9370	0.748	1/2	UC208-109D1

Note (1) These numbers indicate relubricatable type. If maintenance free type is needed, please order without suffix "D1".

Remarks Please refer to page A21 for size of grease fitting.

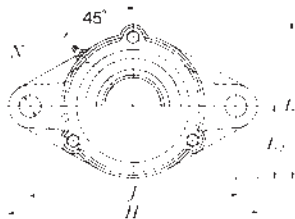

**Cast dust cover type**  
 Open end **C-UCFL...D1**  
 Closed end **CM-UCFL...D1**

Housing number	Unit number (1) pressed steel dust cover type	Unit number (1) cast dust cover type	Nominal dimensions					Mass of unit		
			mm inch					kg lb		
			t max.	A <sub>4</sub>	A <sub>5</sub>	L <sub>1</sub>	L <sub>2</sub>	UCFL	Z(ZM)	C(CM)
FL204D1	<b>Z(ZM)-UCFL201D1</b>	<b>C(CM)-UCFL201D1</b>	2	38	46	67	30	0.5	0.5	0.6
FL204D1	<b>Z(ZM)-UCFL201-008D1</b>	<b>C(CM)-UCFL201-008D1</b>	$\frac{5}{64}$	1 $\frac{1}{2}$	1 $\frac{13}{16}$	2 $\frac{5}{8}$	1 $\frac{3}{16}$	1.1	1.1	1.3
FL204D1	<b>Z(ZM)-UCFL202D1</b>	<b>C(CM)-UCFL202D1</b>	2	38	46	67	30	0.5	0.5	0.6
FL204D1	<b>Z(ZM)-UCFL202-009D1</b>	<b>C(CM)-UCFL202-009D1</b>	$\frac{5}{64}$	1 $\frac{1}{2}$	1 $\frac{13}{16}$	2 $\frac{5}{8}$	1 $\frac{3}{16}$	1.1	1.1	1.3
FL204D1	<b>Z(ZM)-UCFL202-010D1</b>	<b>C(CM)-UCFL202-010D1</b>	$\frac{5}{64}$	1 $\frac{1}{2}$	1 $\frac{13}{16}$	2 $\frac{5}{8}$	1 $\frac{3}{16}$	1.1	1.1	1.3
FL204D1	<b>Z(ZM)-UCFL203D1</b>	<b>C(CM)-UCFL203D1</b>	2	38	46	67	30	0.5	0.5	0.6
FL204D1	<b>Z(ZM)-UCFL203-011D1</b>	<b>C(CM)-UCFL203-011D1</b>	$\frac{5}{64}$	1 $\frac{1}{2}$	1 $\frac{13}{16}$	2 $\frac{5}{8}$	1 $\frac{3}{16}$	1.1	1.1	1.3
FL204D1	<b>Z(ZM)-UCFL204D1</b>	<b>C(CM)-UCFL204D1</b>	2	38	46	67	30	0.4	0.4	0.6
FL204D1	<b>Z(ZM)-UCFL204-012D1</b>	<b>C(CM)-UCFL204-012D1</b>	$\frac{5}{64}$	1 $\frac{1}{2}$	1 $\frac{13}{16}$	2 $\frac{5}{8}$	1 $\frac{3}{16}$	0.9	0.9	1.3
FL205D1	<b>Z(ZM)-UCFL205D1</b>	<b>C(CM)-UCFL205D1</b>	2	40	51	74	34	0.6	0.6	0.8
FL205D1	<b>Z(ZM)-UCFL205-013D1</b>	<b>C(CM)-UCFL205-013D1</b>	$\frac{5}{64}$	1 $\frac{19}{32}$	2	2 $\frac{29}{32}$	1 $\frac{11}{32}$	1.3	1.3	1.8
FL205D1	<b>Z(ZM)-UCFL205-014D1</b>	<b>C(CM)-UCFL205-014D1</b>	$\frac{5}{64}$	1 $\frac{19}{32}$	2	2 $\frac{29}{32}$	1 $\frac{11}{32}$	1.3	1.3	1.8
FL205D1	<b>Z(ZM)-UCFL205-015D1</b>	<b>C(CM)-UCFL205-015D1</b>	$\frac{5}{64}$	1 $\frac{19}{32}$	2	2 $\frac{29}{32}$	1 $\frac{11}{32}$	1.3	1.3	1.8
FL205D1	<b>Z(ZM)-UCFL205-100D1</b>	<b>C(CM)-UCFL205-100D1</b>	$\frac{5}{64}$	1 $\frac{19}{32}$	2	2 $\frac{29}{32}$	1 $\frac{11}{32}$	1.3	1.3	1.8
FL206D1	<b>Z(ZM)-UCFL206D1</b>	<b>C(CM)-UCFL206D1</b>	2	45	56	85	40	0.9	0.9	1.2
FL206D1	<b>Z(ZM)-UCFL206-101D1</b>	<b>C(CM)-UCFL206-101D1</b>	$\frac{5}{64}$	1 $\frac{3}{4}$	2 $\frac{7}{32}$	3 $\frac{11}{32}$	1 $\frac{3}{16}$	2.0	2.0	2.6
FL206D1	<b>Z(ZM)-UCFL206-102D1</b>	<b>C(CM)-UCFL206-102D1</b>	$\frac{5}{64}$	1 $\frac{3}{4}$	2 $\frac{7}{32}$	3 $\frac{11}{32}$	1 $\frac{3}{16}$	2.0	2.0	2.6
FL206D1	<b>Z(ZM)-UCFL206-103D1</b>	<b>C(CM)-UCFL206-103D1</b>	$\frac{5}{64}$	1 $\frac{3}{4}$	2 $\frac{7}{32}$	3 $\frac{11}{32}$	1 $\frac{3}{16}$	2.0	2.0	2.6
FL206D1	—	<b>C(CM)-UCFL206-104D1</b>	$\frac{5}{64}$	1 $\frac{3}{4}$	2 $\frac{7}{32}$	3 $\frac{11}{32}$	1 $\frac{3}{16}$	2.0	2.0	2.6
FL207D1	<b>Z(ZM)-UCFL207D1</b>	<b>C(CM)-UCFL207D1</b>	3	49	59	97	45	1.2	1.2	1.4
FL207D1	<b>Z(ZM)-UCFL207-104D1</b>	<b>C(CM)-UCFL207-104D1</b>	$\frac{1}{8}$	1 $\frac{15}{16}$	2 $\frac{5}{16}$	3 $\frac{13}{16}$	1 $\frac{25}{32}$	2.6	2.6	3.1
FL207D1	<b>Z(ZM)-UCFL207-105D1</b>	<b>C(CM)-UCFL207-105D1</b>	$\frac{1}{8}$	1 $\frac{15}{16}$	2 $\frac{5}{16}$	3 $\frac{13}{16}$	1 $\frac{25}{32}$	2.6	2.6	3.1
FL207D1	<b>Z(ZM)-UCFL207-106D1</b>	<b>C(CM)-UCFL207-106D1</b>	$\frac{1}{8}$	1 $\frac{15}{16}$	2 $\frac{5}{16}$	3 $\frac{13}{16}$	1 $\frac{25}{32}$	2.6	2.6	3.1
FL207D1	—	<b>C(CM)-UCFL207-107D1</b>	$\frac{1}{8}$	1 $\frac{15}{16}$	2 $\frac{5}{16}$	3 $\frac{13}{16}$	1 $\frac{25}{32}$	2.6	2.6	3.1
FL208D1	<b>Z(ZM)-UCFL208D1</b>	<b>C(CM)-UCFL208D1</b>	3	56	66	106	50	1.5	1.5	1.9
FL208D1	<b>Z(ZM)-UCFL208-108D1</b>	<b>C(CM)-UCFL208-108D1</b>	$\frac{1}{8}$	2 $\frac{3}{16}$	2 $\frac{19}{32}$	4 $\frac{3}{16}$	1 $\frac{31}{32}$	3.3	3.3	4.2
FL208D1	<b>Z(ZM)-UCFL208-109D1</b>	<b>C(CM)-UCFL208-109D1</b>	$\frac{1}{8}$	2 $\frac{3}{16}$	2 $\frac{19}{32}$	4 $\frac{3}{16}$	1 $\frac{31}{32}$	3.3	3.3	4.2

## Rhombus flanged unit, cast housing Set screw type

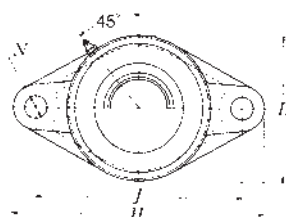
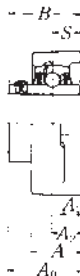
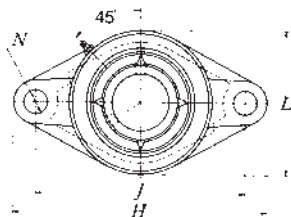

Pressed steel dust cover type  
Open end **Z-UCFL...D1**  
Closed end **ZM-UCFL...D1**

Shaft dia. mm inch	Unit number (1)	Nominal dimensions										Bolt size mm inch	Bearing number
		mm inch											
		H	J	A <sub>2</sub>	A <sub>1</sub>	A	N	L	A <sub>0</sub>	B	S		
45	<b>UCFL209D1</b>	188	148	22	16	38	19	108	52.2	49.2	19	M16	<b>UC209D1</b>
1 <sup>5</sup> / <sub>8</sub>	<b>UCFL209-110D1</b>												UC209-110D1
1 <sup>11</sup> / <sub>16</sub>	<b>UCFL209-111D1</b>	7 <sup>13</sup> / <sub>32</sub>	5 <sup>53</sup> / <sub>64</sub>	<sup>55</sup> / <sub>64</sub>	<sup>5</sup> / <sub>8</sub>	1 <sup>1</sup> / <sub>2</sub>	<sup>3</sup> / <sub>4</sub>	4 <sup>1</sup> / <sub>4</sub>	2 <sup>1</sup> / <sub>16</sub>	1.9370	0.748	<sup>5</sup> / <sub>8</sub>	UC209-111D1
1 <sup>3</sup> / <sub>4</sub>	<b>UCFL209-112D1</b>												UC209-112D1
50	<b>UCFL210D1</b>	197	157	22	16	40	19	115	54.6	51.6	19	M16	<b>UC210D1</b>
1 <sup>13</sup> / <sub>16</sub>	<b>UCFL210-113D1</b>												UC210-113D1
1 <sup>7</sup> / <sub>8</sub>	<b>UCFL210-114D1</b>												UC210-114D1
1 <sup>15</sup> / <sub>16</sub>	<b>UCFL210-115D1</b>	7 <sup>3</sup> / <sub>4</sub>	6 <sup>3</sup> / <sub>16</sub>	<sup>55</sup> / <sub>64</sub>	<sup>5</sup> / <sub>8</sub>	1 <sup>9</sup> / <sub>16</sub>	<sup>3</sup> / <sub>4</sub>	4 <sup>17</sup> / <sub>32</sub>	2 <sup>5</sup> / <sub>32</sub>	2.0315	0.748	<sup>5</sup> / <sub>8</sub>	UC210-115D1
2	<b>UCFL210-200D1</b>												UC210-200D1
55	<b>UCFL211D1</b>	224	184	25	18	43	19	130	58.4	55.6	22.2	M16	<b>UC211D1</b>
2	<b>UCFL211-200D1</b>												UC211-200D1
2 <sup>1</sup> / <sub>16</sub>	<b>UCFL211-201D1</b>												UC211-201D1
2 <sup>1</sup> / <sub>8</sub>	<b>UCFL211-202D1</b>	8 <sup>13</sup> / <sub>32</sub>	7 <sup>1</sup> / <sub>4</sub>	<sup>63</sup> / <sub>64</sub>	<sup>23</sup> / <sub>32</sub>	1 <sup>1</sup> / <sub>16</sub>	<sup>3</sup> / <sub>4</sub>	5 <sup>1</sup> / <sub>8</sub>	2 <sup>19</sup> / <sub>64</sub>	2.1890	0.874	<sup>5</sup> / <sub>8</sub>	UC211-202D1
2 <sup>13</sup> / <sub>16</sub>	<b>UCFL211-203D1</b>												UC211-203D1
60	<b>UCFL212D1</b>	250	202	29	18	48	23	140	68.7	65.1	25.4	M20	<b>UC212D1</b>
2 <sup>1</sup> / <sub>4</sub>	<b>UCFL212-204D1</b>												UC212-204D1
2 <sup>5</sup> / <sub>16</sub>	<b>UCFL212-205D1</b>												UC212-205D1
2 <sup>3</sup> / <sub>8</sub>	<b>UCFL212-206D1</b>	9 <sup>27</sup> / <sub>32</sub>	7 <sup>61</sup> / <sub>64</sub>	1 <sup>9</sup> / <sub>64</sub>	<sup>23</sup> / <sub>32</sub>	1 <sup>7</sup> / <sub>8</sub>	<sup>29</sup> / <sub>32</sub>	5 <sup>1</sup> / <sub>2</sub>	2 <sup>45</sup> / <sub>64</sub>	2.5630	1.000	<sup>3</sup> / <sub>4</sub>	UC212-206D1
2 <sup>7</sup> / <sub>16</sub>	<b>UCFL212-207D1</b>												UC212-207D1
65	<b>UCFL213D1</b>	258	210	30	22	50	23	155	69.7	65.1	25.4	M20	<b>UC213D1</b>
2 <sup>1</sup> / <sub>2</sub>	<b>UCFL213-208D1</b>												UC213-208D1
2 <sup>9</sup> / <sub>16</sub>	<b>UCFL213-209D1</b>	10 <sup>5</sup> / <sub>32</sub>	8 <sup>17</sup> / <sub>64</sub>	1 <sup>3</sup> / <sub>16</sub>	<sup>7</sup> / <sub>8</sub>	1 <sup>31</sup> / <sub>32</sub>	<sup>29</sup> / <sub>32</sub>	6 <sup>3</sup> / <sub>32</sub>	2 <sup>3</sup> / <sub>4</sub>	2.5630	1.000	<sup>3</sup> / <sub>4</sub>	UC213-209D1
70	<b>UCFL214D1</b>	265	216	31	22	54	23	160	75.4	74.6	30.2	M20	<b>UC214D1</b>
2 <sup>5</sup> / <sub>8</sub>	<b>UCFL214-210D1</b>												UC214-210D1
2 <sup>1</sup> / <sub>16</sub>	<b>UCFL214-211D1</b>	10 <sup>7</sup> / <sub>16</sub>	8 <sup>1</sup> / <sub>2</sub>	1 <sup>7</sup> / <sub>32</sub>	<sup>7</sup> / <sub>8</sub>	2 <sup>1</sup> / <sub>8</sub>	<sup>29</sup> / <sub>32</sub>	6 <sup>5</sup> / <sub>16</sub>	2 <sup>31</sup> / <sub>32</sub>	2.9370	1.189	<sup>3</sup> / <sub>4</sub>	UC214-211D1
2 <sup>3</sup> / <sub>4</sub>	<b>UCFL214-212D1</b>												UC214-212D1

Note (1) These numbers indicate relubricatable type. If maintenance free type is needed, please order without suffix "D1".

Remarks Please refer to page A21 for size of grease fitting.

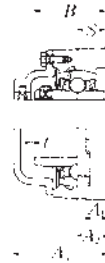
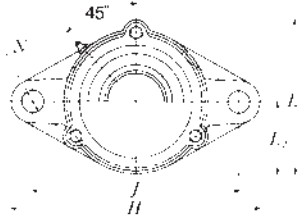

**Cast dust cover type**  
 Open end **C-UCFL...D1**  
 Closed end **CM-UCFL...D1**

Housing number	Unit number (1) pressed steel dust cover type	Unit number (1) cast dust cover type	Nominal dimensions					Mass of unit		
			mm inch					kg lb		
			<i>t</i> max.	<i>A</i> <sub>4</sub>	<i>A</i> <sub>5</sub>	<i>L</i> <sub>1</sub>	<i>L</i> <sub>2</sub>	UCFL	Z(ZM)	C(CM)
FL209D1	Z(ZM)-UCFL209D1	C(CM)-UCFL209D1	3	57	70	113	54	1.8	1.9	2.3
FL209D1	Z(ZM)-UCFL209-110D1	C(CM)-UCFL209-110D1	1/8	2 1/4	2 3/4	4 7/16	2 1/8	4.0	4.2	5.1
FL209D1	Z(ZM)-UCFL209-111D1	C(CM)-UCFL209-111D1								
FL209D1	Z(ZM)-UCFL209-112D1	C(CM)-UCFL209-112D1								
FL210D1	Z(ZM)-UCFL210D1	C(CM)-UCFL210D1	3	60	72	120	58	2.0	2.1	2.7
FL210D1	Z(ZM)-UCFL210-113D1	C(CM)-UCFL210-113D1	1/8	2 3/8	2 27/32	4 29/32	2 3/32	4.4	4.6	6.0
FL210D1	Z(ZM)-UCFL210-114D1	C(CM)-UCFL210-114D1								
FL210D1	Z(ZM)-UCFL210-115D1	C(CM)-UCFL210-115D1								
FL210D1	—	C(CM)-UCFL210-200D1								
FL211D1	Z(ZM)-UCFL211D1	C(CM)-UCFL211D1	4	64	75	133	65	2.9	3.0	3.4
FL211D1	Z(ZM)-UCFL211-200D1	C(CM)-UCFL211-200D1	5/32	2 1/2	2 15/16	5 1/4	2 9/16	6.4	6.6	7.5
FL211D1	Z(ZM)-UCFL211-201D1	C(CM)-UCFL211-201D1								
FL211D1	Z(ZM)-UCFL211-202D1	C(CM)-UCFL211-202D1								
FL211D1	Z(ZM)-UCFL211-203D1	C(CM)-UCFL211-203D1								
FL212D1	Z(ZM)-UCFL212D1	C(CM)-UCFL212D1	4	74	86	144	70	3.8	4.0	4.6
FL212D1	Z(ZM)-UCFL212-204D1	C(CM)-UCFL212-204D1	5/32	2 29/32	3 3/8	5 21/32	2 3/4	8.4	8.8	10
FL212D1	Z(ZM)-UCFL212-205D1	C(CM)-UCFL212-205D1								
FL212D1	Z(ZM)-UCFL212-206D1	C(CM)-UCFL212-206D1								
FL212D1	—	C(CM)-UCFL212-207D1								
FL213D1	Z(ZM)-UCFL213D1	C(CM)-UCFL213D1	4	76	90	157	78	4.8	4.9	5.8
FL213D1	Z(ZM)-UCFL213-208D1	C(CM)-UCFL213-208D1	5/32	3	3 17/32	6 3/16	3 1/16	11	11	13
FL213D1	Z(ZM)-UCFL213-209D1	C(CM)-UCFL213-209D1								
FL214D1	—	C(CM)-UCFL214D1	4	—	98	164	80	5.4	—	7.7
FL214D1	—	C(CM)-UCFL214-210D1	5/32	—	3 27/32	6 15/32	3 5/32	12	—	17
FL214D1	—	C(CM)-UCFL214-211D1								
FL214D1	—	C(CM)-UCFL214-212D1								



## Rhombus flanged unit, cast housing Set screw type

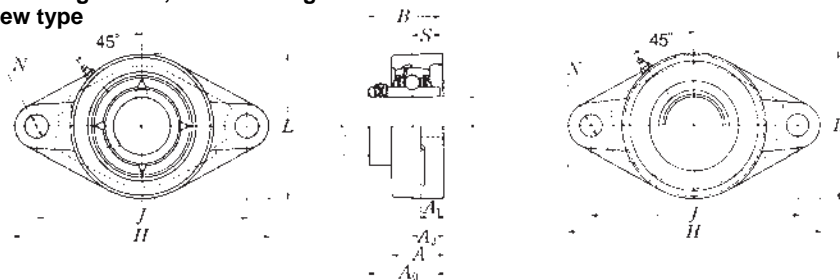

### Pressed steel dust cover type

Open end **Z-UCFL...D1**

Closed end **ZM-UCFL...D1**

Shaft dia. mm inch	Unit number (1)	Nominal dimensions										Bolt size mm inch	Bearing number
		mm inch											
		H	J	A <sub>2</sub>	A <sub>1</sub>	A	N	L	A <sub>0</sub>	B	S		
75 2 <sup>13</sup> / <sub>16</sub>	<b>UCFL215D1</b>	275	225	34	22	56	23	165	78.5	77.8	33.3	M20	UC215D1
2 <sup>7</sup> / <sub>8</sub>	<b>UCFL215-213D1</b>												UC215-213D1
2 <sup>15</sup> / <sub>16</sub>	<b>UCFL215-214D1</b>												UC215-214D1
3	<b>UCFL215-300D1</b>												UC215-300D1
80 3 <sup>1</sup> / <sub>16</sub>	<b>UCFL216D1</b>	290	233	34	22	58	25	180	83.3	82.6	33.3	M22	UC216D1
3 <sup>3</sup> / <sub>8</sub>	<b>UCFL216-301D1</b>												UC216-301D1
3 <sup>3</sup> / <sub>16</sub>	<b>UCFL216-302D1</b>												UC216-302D1
85 3 <sup>1</sup> / <sub>4</sub>	<b>UCFL217D1</b>	305	248	36	24	63	25	190	87.6	85.7	34.1	M22	UC217D1
3 <sup>5</sup> / <sub>16</sub>	<b>UCFL217-304D1</b>												UC217-304D1
3 <sup>7</sup> / <sub>16</sub>	<b>UCFL217-305D1</b>												UC217-305D1
90 3 <sup>1</sup> / <sub>2</sub>	<b>UCFL218D1</b>	320	265	40	24	68	25	205	96.3	96	39.7	M22	UC218D1
	<b>UCFL218-308D1</b>												UC218-308D1

Note (1) These numbers indicate relubricatable type. If maintenance free type is needed, please order without suffix "D1".

Remarks Please refer to page A21 for size of grease fitting.

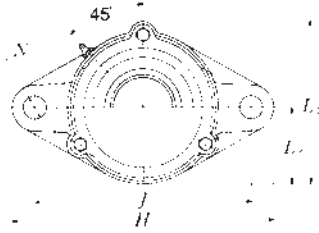

**Cast dust cover type**  
 Open end **C-UCFL...D1**  
 Closed end **CM-UCFL...D1**

Housing number	Unit number pressed steel dust cover type	Unit number (1) cast dust cover type	Nominal dimensions					Mass of unit		
			mm inch					kg lb		
			t max.	A <sub>4</sub>	A <sub>5</sub>	L <sub>1</sub>	L <sub>2</sub>	UCFL	Z(ZM)	C(CM)
FL215D1	—	<b>C(CM)-UCFL215D1</b>	4	—	102	169	82	6.0	—	7.1
FL215D1	—	<b>C(CM)-UCFL215-213D1</b>								
FL215D1	—	<b>C(CM)-UCFL215-214D1</b>								
FL215D1	—	<b>C(CM)-UCFL215-215D1</b>								
FL215D1	—	<b>C(CM)-UCFL215-300D1</b>	5/32	—	4 1/32	6 21/32	3 7/32	13	—	16
FL216D1	—	<b>C(CM)-UCFL216D1</b>	4	—	106	183	90	7.4	—	8.6
FL216D1	—	<b>C(CM)-UCFL216-301D1</b>								
FL216D1	—	<b>C(CM)-UCFL216-302D1</b>								
FL216D1	—	<b>C(CM)-UCFL216-303D1</b>								
FL217D1	—	<b>C(CM)-UCFL217D1</b>	5	—	114	192	95	8.8	—	10
FL217D1	—	<b>C(CM)-UCFL217-304D1</b>								
FL217D1	—	<b>C(CM)-UCFL217-305D1</b>								
FL217D1	—	<b>C(CM)-UCFL217-307D1</b>								
FL218D1	—	<b>C(CM)-UCFL218D1</b>	5	—	122	205	102	11	—	13
FL218D1	—	<b>C(CM)-UCFL218-308D1</b>	13/64	—	4 13/16	8 1/16	4 1/32	24	—	29

## Rhombus flanged unit, cast housing Set screw type

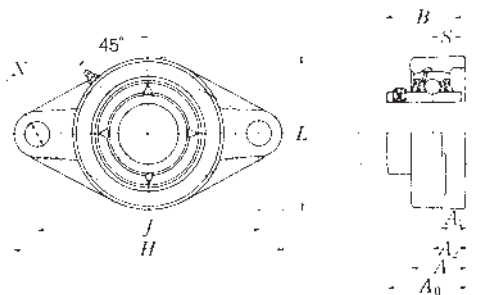

Shaft dia. mm inch	Unit number (1)	Nominal dimensions										Bolt size mm inch
		mm inch										
		H	J	A <sub>2</sub>	A <sub>1</sub>	A	N	L	A <sub>0</sub>	B	S	
25 1 3/16 7/8 15/16 1	<b>UCFL305D1</b> <b>UCFL305-013D1</b> <b>UCFL305-014D1</b> <b>UCFL305-015D1</b> <b>UCFL305-100D1</b>	150	113	16	13	29	19	80	39	38	15	M16
		5 29/32	4 29/64	5/8	1/2	1 5/32	3/4	3 5/32	1 17/32	1.4961	0.591	5/8
30 1 1/16 1 1/8 1 3/16	<b>UCFL306D1</b> <b>UCFL306-101D1</b> <b>UCFL306-102D1</b> <b>UCFL306-103D1</b>	180	134	18	15	32	23	90	44	43	17	M20
		7 3/32	5 3/32	45/64	19/32	1 1/4	29/32	3 17/32	1 47/64	1.6929	0.669	3/4
35 1 1/4 1 5/16 1 3/8 1 7/16	<b>UCFL307D1</b> <b>UCFL307-104D1</b> <b>UCFL307-105D1</b> <b>UCFL307-106D1</b> <b>UCFL307-107D1</b>	185	141	20	16	36	23	100	49	48	19	M20
		7 9/32	5 35/64	25/32	5/8	1 13/32	29/32	3 15/16	1 59/64	1.8898	0.748	3/4
40 1 1/2 1 9/16	<b>UCFL308D1</b> <b>UCFL308-108D1</b> <b>UCFL308-109D1</b>	200	158	23	17	40	23	112	56	52	19	M20
		7 7/8	6 7/32	29/32	21/32	1 9/16	29/32	4 13/32	2 13/64	2.0472	0.748	3/4
45 1 5/8 1 11/16 1 3/4	<b>UCFL309D1</b> <b>UCFL309-110D1</b> <b>UCFL309-111D1</b> <b>UCFL309-112D1</b>	230	177	25	18	44	25	125	60	57	22	M22
		9 1/16	6 31/32	63/64	23/32	1 23/32	63/64	4 29/32	2 29/64	2.2441	0.866	7/8
50 1 13/16 1 7/8 1 15/16	<b>UCFL310D1</b> <b>UCFL310-113D1</b> <b>UCFL310-114D1</b> <b>UCFL310-115D1</b>	240	187	28	19	48	25	140	67	61	22	M22
		9 7/16	7 23/64	1 7/64	3/4	1 7/8	63/64	5 1/2	2 41/64	2.4016	0.866	7/8

Note (1) These numbers indicate relubricatable type. If maintenance free type is needed, please order without suffix "D1".

Remarks Please refer to page A21 for size of grease fitting.

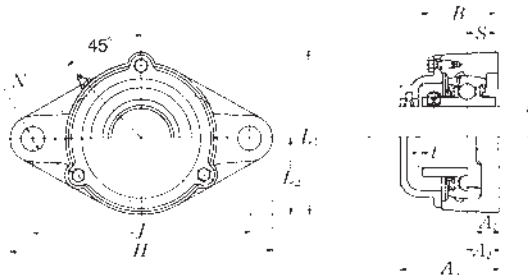

**Cast dust cover type**  
 Open end **C-UCFL...D1**  
 Closed end **CM-UCFL...D1**

Bearing number	Housing number	Unit number (1) cast dust cover type	Nominal dimensions				Mass of unit	
			<i>t</i> max.	<i>A</i> <sub>5</sub>	<i>L</i> <sub>1</sub>	<i>L</i> <sub>2</sub>	UCFL	C(CM)
UC305D1	FL305D1	<b>C(CM)-UCFL305D1</b>	2	56	86	40	0.9	1.2
UC305-013D1	FL305D1	<b>C(CM)-UCFL305-013D1</b>						
UC305-014D1	FL305D1	<b>C(CM)-UCFL305-014D1</b>						
UC305-015D1	FL305D1	<b>C(CM)-UCFL305-015D1</b>	$\frac{5}{64}$	$2\frac{7}{32}$	$3\frac{3}{8}$	$1\frac{9}{16}$	2.0	2.6
UC305-100D1	FL305D1	<b>C(CM)-UCFL305-100D1</b>						
UC306D1	FL306D1	<b>C(CM)-UCFL306D1</b>	2	60	101	45	1.4	1.7
UC306-101D1	FL306D1	<b>C(CM)-UCFL306-101D1</b>						
UC306-102D1	FL306D1	<b>C(CM)-UCFL306-102D1</b>	$\frac{5}{64}$	$2\frac{3}{8}$	$3\frac{31}{32}$	$1\frac{25}{32}$	3.1	3.7
UC306-103D1	FL306D1	<b>C(CM)-UCFL306-103D1</b>						
UC307D1	FL307D1	<b>C(CM)-UCFL307D1</b>	3	68	110	50	1.7	2.1
UC307-104D1	FL307D1	<b>C(CM)-UCFL307-104D1</b>						
UC307-105D1	FL307D1	<b>C(CM)-UCFL307-105D1</b>						
UC307-106D1	FL307D1	<b>C(CM)-UCFL307-106D1</b>	$\frac{1}{8}$	$2\frac{11}{16}$	$4\frac{11}{32}$	$1\frac{31}{32}$	3.7	4.6
UC307-107D1	FL307D1	<b>C(CM)-UCFL307-107D1</b>						
UC308D1	FL308D1	<b>C(CM)-UCFL308D1</b>	3	76	122	56	2.2	2.9
UC308-108D1	FL308D1	<b>C(CM)-UCFL308-108D1</b>						
UC308-109D1	FL308D1	<b>C(CM)-UCFL308-109D1</b>	$\frac{1}{8}$	3	$4\frac{13}{16}$	$2\frac{7}{32}$	4.9	6.4
UC309D1	FL309D1	<b>C(CM)-UCFL309D1</b>	3	80	135	62	3.0	3.8
UC309-110D1	FL309D1	<b>C(CM)-UCFL309-110D1</b>						
UC309-111D1	FL309D1	<b>C(CM)-UCFL309-111D1</b>	$\frac{1}{8}$	$3\frac{3}{32}$	$5\frac{5}{16}$	$2\frac{7}{16}$	6.6	8.4
UC309-112D1	FL309D1	<b>C(CM)-UCFL309-112D1</b>						
UC310D1	FL310D1	<b>C(CM)-UCFL310D1</b>	3	88	152	70	4.1	5.0
UC310-113D1	FL310D1	<b>C(CM)-UCFL310-113D1</b>						
UC310-114D1	FL310D1	<b>C(CM)-UCFL310-114D1</b>	$\frac{1}{8}$	$3\frac{15}{32}$	$5\frac{31}{32}$	$2\frac{3}{4}$	9.0	11
UC310-115D1	FL310D1	<b>C(CM)-UCFL310-115D1</b>						

## Rhombus flanged unit, cast housing Set screw type

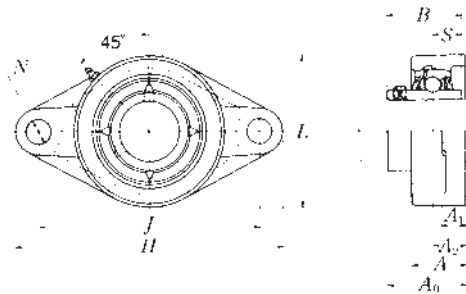

Shaft dia. mm inch	Unit number (1)	Nominal dimensions										Bolt size mm inch
		mm inch										
		H	J	A <sub>2</sub>	A <sub>1</sub>	A	N	L	A <sub>0</sub>	B	S	
55 2	<b>UCFL311D1</b>	250	198	30	20	52	25	150	71	66	25	M22
2 1/16	<b>UCFL311-200D1</b>											
2 1/8	<b>UCFL311-201D1</b>	9 <sup>27</sup> / <sub>32</sub>	7 <sup>51</sup> / <sub>64</sub>	1 <sup>3</sup> / <sub>16</sub>	2 <sup>5</sup> / <sub>32</sub>	2 <sup>1</sup> / <sub>16</sub>	6 <sup>3</sup> / <sub>64</sub>	5 <sup>29</sup> / <sub>32</sub>	2 <sup>51</sup> / <sub>64</sub>	2.5984	0.984	7/8
2 3/16	<b>UCFL311-202D1</b>											
	<b>UCFL311-203D1</b>											
60 2 1/4	<b>UCFL312D1</b>	270	212	33	22	56	31	160	78	71	26	M27
2 5/16	<b>UCFL312-204D1</b>											
2 3/8	<b>UCFL312-205D1</b>	10 <sup>5</sup> / <sub>8</sub>	8 <sup>1</sup> / <sub>2</sub>	1 <sup>19</sup> / <sub>64</sub>	7/8	2 <sup>7</sup> / <sub>32</sub>	1 <sup>7</sup> / <sub>32</sub>	6 <sup>5</sup> / <sub>16</sub>	3 <sup>5</sup> / <sub>64</sub>	2.7953	1.024	1
2 7/16	<b>UCFL312-206D1</b>											
	<b>UCFL312-207D1</b>											
65 2 1/2	<b>UCFL313D1</b>	295	240	33	25	58	31	175	78	75	30	M27
2 9/16	<b>UCFL313-208D1</b>											
	<b>UCFL313-209D1</b>	11 <sup>5</sup> / <sub>8</sub>	9 <sup>29</sup> / <sub>64</sub>	1 <sup>19</sup> / <sub>64</sub>	3 <sup>1</sup> / <sub>32</sub>	2 <sup>9</sup> / <sub>32</sub>	1 <sup>7</sup> / <sub>32</sub>	6 <sup>7</sup> / <sub>8</sub>	3 <sup>5</sup> / <sub>64</sub>	2.9528	1.181	1
70 2 5/8	<b>UCFL314D1</b>	315	250	36	28	61	35	185	81	78	33	M30
2 11/16	<b>UCFL314-210D1</b>											
2 3/4	<b>UCFL314-211D1</b>	12 <sup>13</sup> / <sub>32</sub>	9 <sup>27</sup> / <sub>32</sub>	1 <sup>27</sup> / <sub>64</sub>	1 <sup>3</sup> / <sub>32</sub>	2 <sup>13</sup> / <sub>32</sub>	1 <sup>3</sup> / <sub>8</sub>	7 <sup>9</sup> / <sub>32</sub>	3 <sup>3</sup> / <sub>16</sub>	3.0709	1.299	1 1/8
	<b>UCFL314-212D1</b>											
75 2 13/16	<b>UCFL315D1</b>	320	260	39	30	66	35	195	89	82	32	M30
2 7/8	<b>UCFL315-213D1</b>											
2 15/16	<b>UCFL315-214D1</b>	12 <sup>19</sup> / <sub>32</sub>	10 <sup>15</sup> / <sub>64</sub>	1 <sup>17</sup> / <sub>32</sub>	1 <sup>3</sup> / <sub>16</sub>	2 <sup>19</sup> / <sub>32</sub>	1 <sup>3</sup> / <sub>8</sub>	7 <sup>11</sup> / <sub>16</sub>	3 <sup>1</sup> / <sub>2</sub>	3.2283	1.260	1 1/8
3	<b>UCFL315-215D1</b>											
	<b>UCFL315-300D1</b>											
80 3 1/16	<b>UCFL316D1</b>	355	285	38	32	68	38	210	90	86	34	M33
3 3/8	<b>UCFL316-301D1</b>											
3 1/8	<b>UCFL316-302D1</b>	13 <sup>31</sup> / <sub>32</sub>	11 <sup>7</sup> / <sub>32</sub>	1 <sup>1</sup> / <sub>2</sub>	1 <sup>1</sup> / <sub>4</sub>	2 <sup>11</sup> / <sub>16</sub>	1 <sup>1</sup> / <sub>2</sub>	8 <sup>9</sup> / <sub>32</sub>	3 <sup>35</sup> / <sub>64</sub>	3.3858	1.339	1 1/4
3 3/16	<b>UCFL316-303D1</b>											

Note (1) These numbers indicate relubricatable type. If maintenance free type is needed, please order without suffix "D1".

Remarks Please refer to page A21 for size of grease fitting.

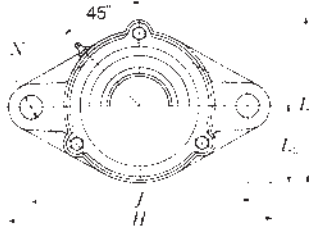

**Cast dust cover type**  
 Open end **C-UCFL...D1**  
 Closed end **CM-UCFL...D1**

Bearing number	Housing number	Unit number (1) cast dust cover type	Nominal dimensions				Mass of unit	
			<i>t</i> max.	<i>A</i> <sub>5</sub>	<i>L</i> <sub>1</sub>	<i>L</i> <sub>2</sub>	UCFL	C(CM)
UC311D1	FL311D1	<b>C(CM)-UCFL311D1</b>	4	92	162	75	4.6	5.9
UC311-200D1	FL311D1	<b>C(CM)-UCFL311-200D1</b>						
UC311-201D1	FL311D1	<b>C(CM)-UCFL311-201D1</b>						
UC311-202D1	FL311D1	<b>C(CM)-UCFL311-202D1</b>	$\frac{5}{32}$	$3\frac{5}{8}$	$6\frac{3}{8}$	$2\frac{15}{16}$	10	13
UC311-203D1	FL311D1	<b>C(CM)-UCFL311-203D1</b>						
UC312D1	FL312D1	<b>C(CM)-UCFL312D1</b>	4	100	175	80	5.7	7.7
UC312-204D1	FL312D1	<b>C(CM)-UCFL312-204D1</b>						
UC312-205D1	FL312D1	<b>C(CM)-UCFL312-205D1</b>						
UC312-206D1	FL312D1	<b>C(CM)-UCFL312-206D1</b>	$\frac{5}{32}$	$3\frac{15}{16}$	$6\frac{7}{8}$	$3\frac{5}{32}$	13	17
UC312-207D1	FL312D1	<b>C(CM)-UCFL312-207D1</b>						
UC313D1	FL313D1	<b>C(CM)-UCFL313D1</b>	4	103	189	88	7.6	9.9
UC313-208D1	FL313D1	<b>C(CM)-UCFL313-208D1</b>						
UC313-209D1	FL313D1	<b>C(CM)-UCFL313-209D1</b>	$\frac{5}{32}$	$4\frac{1}{16}$	$7\frac{1}{16}$	$3\frac{15}{32}$	17	22
UC314D1	FL314D1	<b>C(CM)-UCFL314D1</b>	4	106	198	92	8.6	11
UC314-210D1	FL314D1	<b>C(CM)-UCFL314-210D1</b>						
UC314-211D1	FL314D1	<b>C(CM)-UCFL314-211D1</b>	$\frac{5}{32}$	$4\frac{3}{16}$	$7\frac{25}{32}$	$3\frac{5}{8}$	19	24
UC314-212D1	FL314D1	<b>C(CM)-UCFL314-212D1</b>						
UC315D1	FL315D1	<b>C(CM)-UCFL315D1</b>	4	114	210	98	9.9	12
UC315-213D1	FL315D1	<b>C(CM)-UCFL315-213D1</b>						
UC315-214D1	FL315D1	<b>C(CM)-UCFL315-214D1</b>						
UC315-215D1	FL315D1	<b>C(CM)-UCFL315-215D1</b>	$\frac{5}{32}$	$4\frac{1}{2}$	$8\frac{9}{32}$	$3\frac{27}{32}$	22	26
UC315-300D1	FL315D1	<b>C(CM)-UCFL315-300D1</b>						
UC316D1	FL316D1	<b>C(CM)-UCFL316D1</b>	4	116	222	105	13	16
UC316-301D1	FL316D1	<b>C(CM)-UCFL316-301D1</b>						
UC316-302D1	FL316D1	<b>C(CM)-UCFL316-302D1</b>	$\frac{5}{32}$	$4\frac{9}{16}$	$8\frac{3}{4}$	$4\frac{1}{8}$	29	35
UC316-303D1	FL316D1	<b>C(CM)-UCFL316-303D1</b>						

## Rhombus flanged unit, cast housing Set screw type

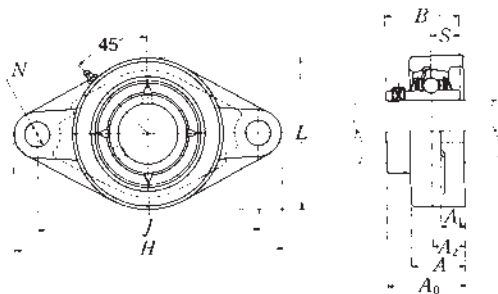

Shaft dia. mm inch	Unit number <sup>(1)</sup>	Nominal dimensions										Bolt size mm inch
		mm inch										
		H	J	A <sub>2</sub>	A <sub>1</sub>	A	N	L	A <sub>0</sub>	B	S	
85 3 1/4	UCFL317D1	370	300	44	32	74	38	220	100	96	40	M33
3 5/16	UCFL317-304D1											
3 5/16	UCFL317-305D1	14 9/16	11 13/16	1 47/64	1 1/4	2 29/32	1 1/2	8 21/32	3 15/16	3.7795	1.575	1 1/4
3 7/16	UCFL317-307D1											
90 3 7/16	UCFL318D1	385	315	44	36	76	38	235	100	96	40	M33
3 7/16	UCFL318-307D1											
3 7/16	UCFL318-308D1	15 5/32	12 13/32	1 47/64	1 13/32	3	1 1/2	9 1/4	3 15/16	3.7795	1.575	1 1/4
95 3 5/8	UCFL319D1	405	330	59	40	94	41	250	121	103	41	M36
3 5/8	UCFL319-310D1											
3 11/16	UCFL319-311D1	15 15/16	12 89/64	2 21/64	1 9/16	3 11/16	1 39/64	9 27/32	4 48/64	4.0551	1.614	1 3/8
3 3/4	UCFL319-312D1											
100 3 13/16	UCFL320D1	440	360	59	40	94	44	270	125	108	42	M39
3 13/16	UCFL320-313D1											
3 7/8	UCFL320-314D1											
3 15/16	UCFL320-315D1	17 5/16	14 11/64	2 21/64	1 9/16	3 11/16	1 47/64	10 5/8	4 59/64	4.2520	1.654	1 1/2
4	UCFL320-400D1											
105 3 13/16	UCFL321D1	440	360	59	40	94	44	270	127	112	44	M39
110 3 7/8	UCFL322D1	470	390	60	42	96	44	300	131	117	46	M39
120 3 15/16	UCFL324D1	520	430	65	48	110	47	330	140	126	51	M42
130 3 15/16	UCFL326D1	550	460	65	50	115	47	360	146	135	54	M42
140 3 15/16	UCFL328D1	600	500	75	60	125	51	400	161	145	59	M45

Note <sup>(1)</sup> These numbers indicate relubricatable type. If maintenance free type is needed, please order without suffix "D1".

Remarks Please refer to page A21 for size of grease fitting.

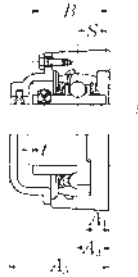
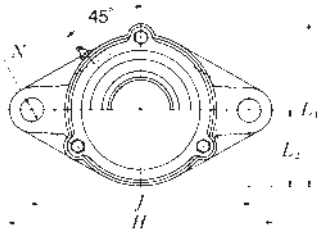

**Cast dust cover type**

Open end **C-UCFL...D1**

Closed end **CM-UCFL...D1**

Bearing number	Housing number	Unit number (1) cast dust cover type	Nominal dimensions				Mass of unit	
			<i>t</i> max.	<i>A</i> <sub>5</sub>	<i>L</i> <sub>1</sub>	<i>L</i> <sub>2</sub>	UCFL	C(CM)
UC317D1	FL317D1	<b>C(CM)-UCFL317D1</b>	5	127	234	110	15	18
UC317-304D1	FL317D1	<b>C(CM)-UCFL317-304D1</b>						
UC317-305D1	FL317D1	<b>C(CM)-UCFL317-305D1</b>	$\frac{13}{64}$	5	$9\frac{7}{32}$	$4\frac{11}{32}$	33	40
UC317-307D1	FL317D1	<b>C(CM)-UCFL317-307D1</b>						
UC318D1	FL318D1	<b>C(CM)-UCFL318D1</b>	5	129	247	118	17	21
UC318-307D1	FL318D1	<b>C(CM)-UCFL318-307D1</b>						
UC318-308D1	FL318D1	<b>C(CM)-UCFL318-308D1</b>	$\frac{13}{64}$	$5\frac{3}{32}$	$9\frac{23}{32}$	$4\frac{21}{32}$	37	46
UC319D1	FL319D1	<b>C(CM)-UCFL319D1</b>	5	149	260	125	22	26
UC319-310D1	FL319D1	<b>C(CM)-UCFL319-310D1</b>						
UC319-311D1	FL319D1	<b>C(CM)-UCFL319-311D1</b>	$\frac{13}{64}$	$5\frac{7}{8}$	$10\frac{1}{4}$	$4\frac{29}{32}$	49	57
UC319-312D1	FL319D1	<b>C(CM)-UCFL319-312D1</b>						
UC320D1	FL320D1	<b>C(CM)-UCFL320D1</b>	5	154	280	135	26	31
UC320-313D1	FL320D1	<b>C(CM)-UCFL320-313D1</b>						
UC320-314D1	FL320D1	<b>C(CM)-UCFL320-314D1</b>						
UC320-315D1	FL320D1	<b>C(CM)-UCFL320-315D1</b>	$\frac{13}{64}$	$6\frac{1}{16}$	$11\frac{1}{32}$	$5\frac{5}{16}$	57	68
UC320-400D1	FL320D1	<b>C(CM)-UCFL320-400D1</b>						
UC321D1	FL321D1	<b>C(CM)-UCFL321D1</b>	5	156	287	135	27	32
UC322D1	FL322D1	<b>C(CM)-UCFL322D1</b>	5	160	315	150	34	39
UC324D1	FL324D1	<b>C(CM)-UCFL324D1</b>	5	172	342	165	48	52
UC326D1	FL326D1	<b>C(CM)-UCFL326D1</b>	6	178	376	180	58	64
UC328D1	FL328D1	<b>C(CM)-UCFL328D1</b>	6	192	410	200	81	90



## Rhombus flanged unit, cast housing Set screw type

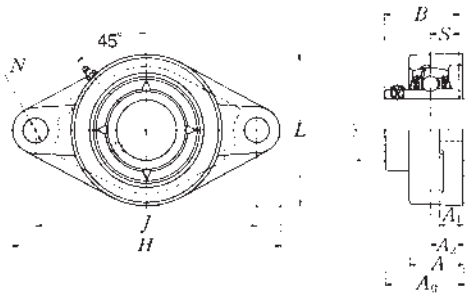

Shaft dia. mm inch	Unit number (1)	Nominal dimensions										Bolt size mm inch
		mm inch										
		H	J	A <sub>2</sub>	A <sub>1</sub>	A	N	L	A <sub>0</sub>	B	S	
25 13/16 7/8 15/16 1	<b>UCFLX05D1</b> <b>UCFLX05-013D1</b> <b>UCFLX05-014D1</b> <b>UCFLX05-015D1</b> <b>UCFLX05-100D1</b>	141 5 9/16	117 4 39/64	18 45/64	13 1/2	30 1 3/16	12 15/32	83 3 9/32	40.2 1 37/64	38.1 1.5000	15.9 0.626	M10 3/8
30 1 1/16 1 1/8 1 3/16 1 1/4	<b>UCFLX06D1</b> <b>UCFLX06-101D1</b> <b>UCFLX06-102D1</b> <b>UCFLX06-103D1</b> <b>UCFLX06-104D1</b>	156 6 5/32	130 5 1/8	19 3/4	15 19/32	34 1 11/32	16 5/8	95 3 3/4	44.4 1 3/4	42.9 1.6890	17.5 0.689	M14 1/2
35 1 5/16 1 3/8 1 7/16	<b>UCFLX07D1</b> <b>UCFLX07-105D1</b> <b>UCFLX07-106D1</b> <b>UCFLX07-107D1</b>	171 6 23/32	144 5 43/64	21 53/64	16 5/8	38 1 1/2	16 5/8	105 4 1/8	51.2 2 1/64	49.2 1.9370	19 0.748	M14 1/2
40 1 1/2 1 9/16	<b>UCFLX08D1</b> <b>UCFLX08-108D1</b> <b>UCFLX08-109D1</b>	179 7 1/16	148 5 53/64	22 55/64	16 5/8	40 1 9/16	16 5/8	111 4 3/8	52.2 2 1/16	49.2 1.9370	19 0.748	M14 1/2
45 1 5/8 1 11/16 1 3/4 1 13/16	<b>UCFLX09D1</b> <b>UCFLX09-110D1</b> <b>UCFLX09-111D1</b> <b>UCFLX09-112D1</b> <b>UCFLX09-113D1</b>	189 7 7/16	157 6 3/16	23 29/32	16 5/8	40 1 9/16	16 5/8	116 4 9/16	55.6 2 3/16	51.6 2.0315	19 0.748	M14 1/2
50 1 7/8 1 15/16 2	<b>UCFLX10D1</b> <b>UCFLX10-114D1</b> <b>UCFLX10-115D1</b> <b>UCFLX10-200D1</b>	216 8 1/2	184 7 1/4	26 1 1/32	18 23/32	44 1 23/32	19 3/4	133 5 1/4	59.4 2 11/32	55.6 2.1890	22.2 0.874	M16 5/8

Note (1) These numbers indicate relubricatable type. If maintenance free type is needed, please order without suffix "D1".

Remarks Please refer to page A21 for size of grease fitting.

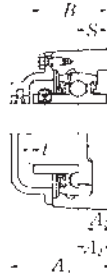
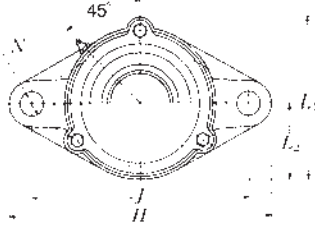

**Cast dust cover type**  
 Open end **C-UCFL...D1**  
 Closed end **CM-UCFL...D1**

Bearing number	Housing number	Unit number (*) cast dust cover type	Nominal dimensions				Mass of unit	
			<i>t</i> max.	<i>A</i> <sub>5</sub>	<i>L</i> <sub>1</sub>	<i>L</i> <sub>2</sub>	kg lb	
			mm inch				UCFL	C(CM)
UCX05D1	FLX05D1	<b>C(CM)-UCFLX05D1</b>	2	56	86	41.5	1.0	1.2
UCX05-013D1	FLX05D1	<b>C(CM)-UCFLX05-013D1</b>						
UCX05-014D1	FLX05D1	<b>C(CM)-UCFLX05-014D1</b>						
UCX05-015D1	FLX05D1	<b>C(CM)-UCFLX05-015D1</b>	$\frac{5}{64}$	$2\frac{7}{32}$	$3\frac{3}{8}$	$1\frac{5}{8}$	2.2	2.6
UCX05-100D1	FLX05D1	<b>C(CM)-UCFLX05-100D1</b>						
UCX06D1	FLX06D1	<b>C(CM)-UCFLX06D1</b>	2	59	98.5	47.5	1.5	1.8
UCX06-101D1	FLX06D1	<b>C(CM)-UCFLX06-101D1</b>						
UCX06-102D1	FLX06D1	<b>C(CM)-UCFLX06-102D1</b>						
UCX06-103D1	FLX06D1	<b>C(CM)-UCFLX06-103D1</b>	$\frac{5}{64}$	$2\frac{5}{16}$	$3\frac{7}{8}$	$1\frac{7}{8}$	3.3	4.0
UC207-104D1	FLX06D1	<b>C(CM)-UCFLX06-104D1</b>						
UCX07D1	FLX07D1	<b>C(CM)-UCFLX07D1</b>	3	66	108.5	52.5	1.8	2.2
UCX07-105D1	FLX07D1	<b>C(CM)-UCFLX07-105D1</b>						
UCX07-106D1	FLX07D1	<b>C(CM)-UCFLX07-106D1</b>	$\frac{1}{8}$	$2\frac{19}{32}$	$4\frac{9}{32}$	$2\frac{1}{16}$	4.0	4.9
UCX07-107D1	FLX07D1	<b>C(CM)-UCFLX07-107D1</b>						
UCX08D1	FLX08D1	<b>C(CM)-UCFLX08D1</b>	3	70	114.5	55.5	2.0	2.4
UCX08-108D1	FLX08D1	<b>C(CM)-UCFLX08-108D1</b>						
UCX08-109D1	FLX08D1	<b>C(CM)-UCFLX08-109D1</b>	$\frac{1}{8}$	$2\frac{3}{4}$	$4\frac{1}{4}$	$2\frac{3}{16}$	4.4	5.3
UCX09D1	FLX09D1	<b>C(CM)-UCFLX09D1</b>	3	73	119.5	58	2.2	2.7
UCX09-110D1	FLX09D1	<b>C(CM)-UCFLX09-110D1</b>						
UCX09-111D1	FLX09D1	<b>C(CM)-UCFLX09-111D1</b>						
UCX09-112D1	FLX09D1	<b>C(CM)-UCFLX09-112D1</b>	$\frac{1}{8}$	$2\frac{7}{8}$	$4\frac{29}{32}$	$2\frac{9}{32}$	4.9	6.0
UC210-113D1	FLX09D1	<b>C(CM)-UCFLX09-113D1</b>						
UCX10D1	FLX10D1	<b>C(CM)-UCFLX10D1</b>	3	76	133.5	66.5	3.0	3.6
UCX10-114D1	FLX10D1	<b>C(CM)-UCFLX10-114D1</b>						
UCX10-115D1	FLX10D1	<b>C(CM)-UCFLX10-115D1</b>	$\frac{1}{8}$	3	$5\frac{1}{4}$	$2\frac{5}{8}$	6.6	7.9
UC211-200D1	FLX10D1	<b>C(CM)-UCFLX10-200D1</b>						

## Modified rhombus flanged unit, cast housing Set screw type

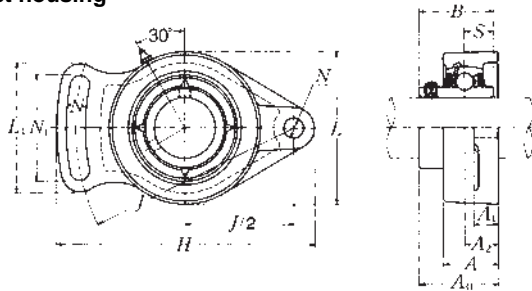

Shaft dia. mm inch	Unit number (1)	Nominal dimensions											Bolt size mm inch	
		mm inch												
		H	J	A <sub>2</sub>	A <sub>1</sub>	A	N	N <sub>1</sub>	L	L <sub>1</sub>	A <sub>0</sub>	B	S	
12	UCFA201D1	98	78	15	12	25.5	10	40	60	50	33.3	31	12.7	M8
1/2	UCFA201-008D1	3 <sup>27</sup> / <sub>32</sub>	3 <sup>1</sup> / <sub>16</sub>	1 <sup>9</sup> / <sub>32</sub>	1 <sup>5</sup> / <sub>32</sub>	1	2 <sup>5</sup> / <sub>64</sub>	1 <sup>9</sup> / <sub>16</sub>	2 <sup>3</sup> / <sub>8</sub>	1 <sup>31</sup> / <sub>32</sub>	1 <sup>5</sup> / <sub>16</sub>	1.2205	0.500	5/16
15	UCFA202D1	98	78	15	12	25.5	10	40	60	50	33.3	31	12.7	M8
9/16	UCFA202-009D1	3 <sup>27</sup> / <sub>32</sub>	3 <sup>1</sup> / <sub>16</sub>	1 <sup>9</sup> / <sub>32</sub>	1 <sup>5</sup> / <sub>32</sub>	1	2 <sup>5</sup> / <sub>64</sub>	1 <sup>9</sup> / <sub>16</sub>	2 <sup>3</sup> / <sub>8</sub>	1 <sup>31</sup> / <sub>32</sub>	1 <sup>5</sup> / <sub>16</sub>	1.2205	0.500	5/16
5/8	UCFA202-010D1	3 <sup>27</sup> / <sub>32</sub>	3 <sup>1</sup> / <sub>16</sub>	1 <sup>9</sup> / <sub>32</sub>	1 <sup>5</sup> / <sub>32</sub>	1	2 <sup>5</sup> / <sub>64</sub>	1 <sup>9</sup> / <sub>16</sub>	2 <sup>3</sup> / <sub>8</sub>	1 <sup>31</sup> / <sub>32</sub>	1 <sup>5</sup> / <sub>16</sub>	1.2205	0.500	5/16
17	UCFA203D1	98	78	15	12	25.5	10	40	60	50	33.3	31	12.7	M8
11/16	UCFA203-011D1	3 <sup>27</sup> / <sub>32</sub>	3 <sup>1</sup> / <sub>16</sub>	1 <sup>9</sup> / <sub>32</sub>	1 <sup>5</sup> / <sub>32</sub>	1	2 <sup>5</sup> / <sub>64</sub>	1 <sup>9</sup> / <sub>16</sub>	2 <sup>3</sup> / <sub>8</sub>	1 <sup>31</sup> / <sub>32</sub>	1 <sup>5</sup> / <sub>16</sub>	1.2205	0.500	5/16
20	UCFA204D1	98	78	15	12	25.5	10	40	60	50	33.3	31	12.7	M8
3/4	UCFA204-012D1	3 <sup>27</sup> / <sub>32</sub>	3 <sup>1</sup> / <sub>16</sub>	1 <sup>9</sup> / <sub>32</sub>	1 <sup>5</sup> / <sub>32</sub>	1	2 <sup>5</sup> / <sub>64</sub>	1 <sup>9</sup> / <sub>16</sub>	2 <sup>3</sup> / <sub>8</sub>	1 <sup>31</sup> / <sub>32</sub>	1 <sup>5</sup> / <sub>16</sub>	1.2205	0.500	5/16
25	UCFA205D1	124	96	15	14	26.5	13	49	70	64	34.8	34.1	14.3	M10
13/16	UCFA205-013D1													
7/8	UCFA205-014D1	4 <sup>7</sup> / <sub>8</sub>	3 <sup>25</sup> / <sub>32</sub>	1 <sup>9</sup> / <sub>32</sub>	9/16	1 <sup>1</sup> / <sub>32</sub>	3 <sup>3</sup> / <sub>64</sub>	1 <sup>15</sup> / <sub>16</sub>	2 <sup>3</sup> / <sub>4</sub>	2 <sup>17</sup> / <sub>32</sub>	1 <sup>3</sup> / <sub>8</sub>	1.3425	0.563	3/8
15/16	UCFA205-015D1													
1	UCFA205-100D1													
30	UCFA206D1	141	115	18	14	31	13	53	80	68	40.2	38.1	15.9	M10
1 1/16	UCFA206-101D1													
1 1/8	UCFA206-102D1	5 <sup>9</sup> / <sub>16</sub>	4 <sup>17</sup> / <sub>32</sub>	4 <sup>5</sup> / <sub>64</sub>	9/16	1 <sup>7</sup> / <sub>32</sub>	3 <sup>3</sup> / <sub>64</sub>	2 <sup>3</sup> / <sub>32</sub>	3 <sup>5</sup> / <sub>32</sub>	2 <sup>11</sup> / <sub>16</sub>	1 <sup>37</sup> / <sub>64</sub>	1.5000	0.626	3/8
1 3/16	UCFA206-103D1													
1 1/4	UCFA206-104D1													
35	UCFA207D1	155	128	20	16	34	15	60	90	75	45.4	42.9	17.5	M12
1 1/4	UCFA207-104D1													
1 5/16	UCFA207-105D1	6 <sup>3</sup> / <sub>32</sub>	5 <sup>1</sup> / <sub>32</sub>	2 <sup>5</sup> / <sub>32</sub>	5/8	1 <sup>11</sup> / <sub>32</sub>	1 <sup>9</sup> / <sub>32</sub>	2 <sup>3</sup> / <sub>8</sub>	3 <sup>17</sup> / <sub>32</sub>	2 <sup>15</sup> / <sub>16</sub>	1 <sup>25</sup> / <sub>32</sub>	1.6890	0.689	7/16
1 3/8	UCFA207-106D1													
1 7/16	UCFA207-107D1													
40	UCFA208D1	171	142	22	16	36	15	69	100	84	52.2	49.2	19	M12
1 1/2	UCFA208-108D1	6 <sup>23</sup> / <sub>32</sub>	5 <sup>19</sup> / <sub>32</sub>	5 <sup>5</sup> / <sub>64</sub>	5/8	1 <sup>13</sup> / <sub>32</sub>	1 <sup>9</sup> / <sub>32</sub>	2 <sup>23</sup> / <sub>32</sub>	3 <sup>15</sup> / <sub>16</sub>	3 <sup>5</sup> / <sub>16</sub>	2 <sup>1</sup> / <sub>16</sub>	1.9370	0.748	7/16
1 9/16	UCFA208-109D1													

Note (1) These numbers indicate relubricatable type. If maintenance free type is needed, please order without suffix "D1".

Remarks Please refer to page A21 for size of grease fitting.

Bearing number	Housing number	Mass of unit
		kg lb
UC201D1	FA204D1	0.5
UC201-008D1	FA204D1	1.1
UC202D1	FA204D1	0.5
UC202-009D1	FA204D1	1.1
UC202-010D1	FA204D1	
UC203D1	FA204D1	0.5
UC203-011D1	FA204D1	1.1
UC204D1	FA204D1	0.5
UC204-012D1	FA204D1	1.1
UC205D1	FA205D1	0.7
UC205-013D1	FA205D1	1.5
UC205-014D1	FA205D1	
UC205-015D1	FA205D1	
UC205-100D1	FA205D1	
UC206D1	FA206D1	0.9
UC206-101D1	FA206D1	2.0
UC206-102D1	FA206D1	
UC206-103D1	FA206D1	
UC206-104D1	FA206D1	
UC207D1	FA207D1	1.2
UC207-104D1	FA207D1	2.6
UC207-105D1	FA207D1	
UC207-106D1	FA207D1	
UC207-107D1	FA207D1	
UC208D1	FA208D1	1.5
UC208-108D1	FA208D1	3.3
UC208-109D1	FA208D1	

## Modified rhombus flanged unit, cast housing Set screw type

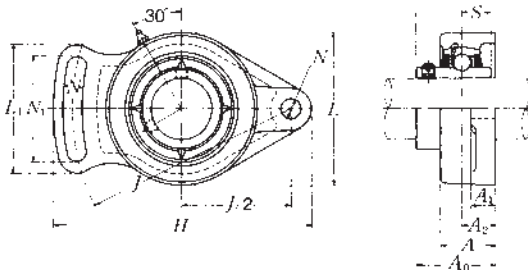

Shaft dia. mm inch	Unit number (1)	Nominal dimensions											Bolt size mm inch	
		mm inch												
		H	J	A <sub>2</sub>	A <sub>1</sub>	A	N	N <sub>1</sub>	L	L <sub>1</sub>	A <sub>0</sub>	B	S	
45	<b>UCFA209D1</b>	179	146	22	18	38	17	72	110	88	52.2	49.2	19	M14
1 <sup>5</sup> / <sub>8</sub>	<b>UCFA209-110D1</b>													
1 <sup>11</sup> / <sub>16</sub>	<b>UCFA209-111D1</b>	7 <sup>1</sup> / <sub>16</sub>	5 <sup>3</sup> / <sub>4</sub>	55 <sup>5</sup> / <sub>64</sub>	23 <sup>23</sup> / <sub>32</sub>	1 <sup>1</sup> / <sub>2</sub>	43 <sup>43</sup> / <sub>64</sub>	2 <sup>27</sup> / <sub>32</sub>	4 <sup>11</sup> / <sub>32</sub>	3 <sup>15</sup> / <sub>32</sub>	2 <sup>1</sup> / <sub>16</sub>	1.9370	0.748	1/2
1 <sup>3</sup> / <sub>4</sub>	<b>UCFA209-112D1</b>													
50	<b>UCFA210D1</b>	189	155	22	18	40	17	75	115	92	54.6	51.6	19	M14
1 <sup>13</sup> / <sub>16</sub>	<b>UCFA210-113D1</b>													
1 <sup>7</sup> / <sub>8</sub>	<b>UCFA210-114D1</b>													
1 <sup>15</sup> / <sub>16</sub>	<b>UCFA210-115D1</b>	7 <sup>7</sup> / <sub>16</sub>	6 <sup>3</sup> / <sub>32</sub>	55 <sup>55</sup> / <sub>64</sub>	23 <sup>23</sup> / <sub>32</sub>	1 <sup>9</sup> / <sub>16</sub>	43 <sup>43</sup> / <sub>64</sub>	2 <sup>15</sup> / <sub>16</sub>	4 <sup>17</sup> / <sub>32</sub>	3 <sup>5</sup> / <sub>8</sub>	2 <sup>5</sup> / <sub>32</sub>	2.0315	0.748	1/2
2	<b>UCFA210-200D1</b>													
55	<b>UCFA211D1</b>	216	182	26	20	43	17	85	130	102	59.4	55.6	22.2	M14
2	<b>UCFA211-200D1</b>													
2 <sup>1</sup> / <sub>16</sub>	<b>UCFA211-201D1</b>													
2 <sup>1</sup> / <sub>8</sub>	<b>UCFA211-202D1</b>	8 <sup>8</sup> / <sub>8</sub>	7 <sup>5</sup> / <sub>32</sub>	1 <sup>1</sup> / <sub>32</sub>	25 <sup>25</sup> / <sub>32</sub>	1 <sup>1</sup> / <sub>16</sub>	43 <sup>43</sup> / <sub>64</sub>	3 <sup>11</sup> / <sub>32</sub>	5 <sup>1</sup> / <sub>8</sub>	4 <sup>1</sup> / <sub>32</sub>	2 <sup>11</sup> / <sub>32</sub>	2.1890	0.874	1/2
2 <sup>3</sup> / <sub>16</sub>	<b>UCFA211-203D1</b>													

Note (1) These numbers indicate relubricatable type. If maintenance free type is needed, please order without suffix "D1".

Remarks Please refer to page A21 for size of grease fitting.

<b>Bearing number</b>	<b>Housing number</b>	<b>Mass of unit</b> kg lb
UC209D1	FA209D1	1.9
UC209-110D1	FA209D1	4.2
UC209-111D1	FA209D1	
UC209-112D1	FA209D1	
UC210D1	FA210D1	2.2
UC210-113D1	FA210D1	4.9
UC210-114D1	FA210D1	
UC210-115D1	FA210D1	
UC210-200D1	FA210D1	
UC211D1	FA211D1	2.9
UC211-200D1	FA211D1	6.4
UC211-201D1	FA211D1	
UC211-202D1	FA211D1	
UC211-203D1	FA211D1	

## Modified flanged unit, cast housing Set screw type

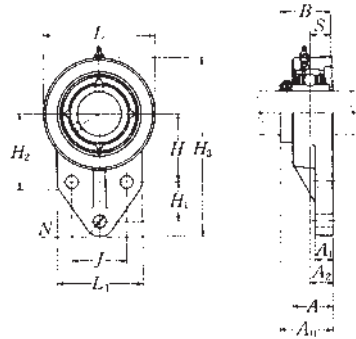

Shaft dia. mm inch	Unit number <sup>(1)</sup>	Nominal dimensions														
		mm inch														
		$H_3$	$J$	$A_2$	$A_1$	$A$	$N$	$H$	$H_1$	$L_1$	$H_2$	$L$	$A_0$	$B$	$S$	
12 1/2	UCFH201D1 UCFH201-008D1	110 4 11/32	32 1 17/64	15 19/32	13 1/2	25.5 1	10 25/64	42 1 21/32	27 1 1/16	52 2 1/16	52 2 1/16	62 2 7/16	33.3 1 5/16	31 1.2205	12.7 0.500	
15 9/16 5/8	UCFH202D1 UCFH202-009D1 UCFH202-010D1	110 4 11/32	32 1 17/64	15 19/32	13 1/2	25.5 1	10 25/64	42 1 21/32	27 1 1/16	52 2 1/16	52 2 1/16	62 2 7/16	33.3 1 5/16	31 1.2205	12.7 0.500	
17 1 1/16	UCFH203D1 UCFH203-011D1	110 4 11/32	32 1 17/64	15 19/32	13 1/2	25.5 1	10 25/64	42 1 21/32	27 1 1/16	52 2 1/16	52 2 1/16	62 2 7/16	33.3 1 5/16	31 1.2205	12.7 0.500	
20 3/4	UCFH204D1 UCFH204-012D1	110 4 11/32	32 1 17/64	15 19/32	13 1/2	25.5 1	10 25/64	42 1 21/32	27 1 1/16	52 2 1/16	52 2 1/16	62 2 7/16	33.3 1 5/16	31 1.2205	12.7 0.500	
25 13/16 7/8 15/16	UCFH205D1 UCFH205-013D1 UCFH205-014D1 UCFH205-015D1	116 4 9/16	34 1 11/32	16 5/8	13 1/2	27 1 1/16	10 25/64	45 1 49/64	27 1 1/16	56 2 7/32	52 2 1/16	68 2 11/16	35.8 1 13/32	34.1 1.3425	14.3 0.563	
1 30 1 1/16 1 1/8 1 3/16 1 1/4	UCFH206D1 UCFH206-101D1 UCFH206-102D1 UCFH206-103D1 UCFH206-104D1	130 5 1/8	40 1 37/64	18 45/64	13 1/2	31 1 7/32	10 25/64	50 1 31/32	29 1 9/64	65 2 9/16	55 2 5/32	78 3 1/16	40.2 1 37/64	38.1 1.5000	15.9 0.626	
35 1 1/4 1 5/16 1 3/8 1 7/16	UCFH207D1 UCFH207-104D1 UCFH207-105D1 UCFH207-106D1 UCFH207-107D1	144 5 21/32	46 1 13/16	19 3/4	15 19/32	34 1 11/32	10 25/64	55 2 1/64	32 1 7/64	70 2 3/4	62 2 7/16	90 3 17/32	44.4 1 3/4	42.9 1.6890	17.5 0.689	

Note <sup>(1)</sup> These numbers indicate relubricatable type. If maintenance free type is needed, please order without suffix "D1".

Remarks Please refer to page A21 for size of grease fitting.

Bolt size	Bearing number	Housing number	Mass of unit	
			kg	lb
M8	UC201D1	FH204D1	0.6	
$\frac{5}{16}$	UC201-008D1	FH204D1	1.3	
M8	UC202D1	FH204D1	0.6	
$\frac{5}{16}$	UC202-009D1	FH204D1	1.3	
$\frac{5}{16}$	UC202-010D1	FH204D1		
M8	UC203D1	FH204D1	0.6	
$\frac{5}{16}$	UC203-011D1	FH204D1	1.3	
M8	UC204D1	FH204D1	0.6	
$\frac{5}{16}$	UC204-012D1	FH204D1	1.3	
M8	UC205D1	FH205D1	0.7	
$\frac{5}{16}$	UC205-013D1	FH205D1		
$\frac{5}{16}$	UC205-014D1	FH205D1	1.5	
$\frac{5}{16}$	UC205-015D1	FH205D1		
$\frac{5}{16}$	UC205-100D1	FH205D1		
M8	UC206D1	FH206D1	0.9	
$\frac{5}{16}$	UC206-101D1	FH206D1		
$\frac{5}{16}$	UC206-102D1	FH206D1	2.0	
$\frac{5}{16}$	UC206-103D1	FH206D1		
$\frac{5}{16}$	UC206-104D1	FH206D1		
M8	UC207D1	FH207D1	1.3	
$\frac{5}{16}$	UC207-104D1	FH207D1		
$\frac{5}{16}$	UC207-105D1	FH207D1	2.9	
$\frac{5}{16}$	UC207-106D1	FH207D1		
$\frac{5}{16}$	UC207-107D1	FH207D1		



## Modified flanged unit, cast housing Set screw type

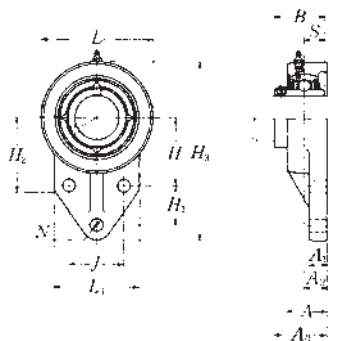

Shaft dia. mm inch	Unit number <sup>(1)</sup>	Nominal dimensions													
		mm inch													
		$H_3$	$J$	$A_2$	$A_1$	$A$	$N$	$H$	$H_1$	$L_1$	$H_2$	$L$	$A_0$	$B$	$S$
40	<b>UCFH208D1</b>	164	50	21	16	36	12	60	41	78	72	100	51.2	49.2	19
$1\frac{1}{2}$	<b>UCFH208-108D1</b>	$6\frac{15}{32}$	$1\frac{31}{32}$	$\frac{53}{64}$	$\frac{5}{8}$	$1\frac{13}{32}$	$\frac{15}{32}$	$2\frac{23}{64}$	$1\frac{39}{64}$	$3\frac{1}{16}$	$2\frac{27}{32}$	$3\frac{15}{16}$	$2\frac{1}{64}$	1.9370	0.748
$1\frac{9}{16}$	<b>UCFH208-109D1</b>														
45	<b>UCFH209D1</b>	174	54	22	18	38	12	65	43	80	76	106	52.2	49.2	19
$1\frac{5}{8}$	<b>UCFH209-110D1</b>														
$1\frac{11}{16}$	<b>UCFH209-111D1</b>	$6\frac{27}{32}$	$2\frac{1}{8}$	$\frac{55}{64}$	$\frac{23}{32}$	$1\frac{1}{2}$	$\frac{15}{32}$	$2\frac{9}{16}$	$1\frac{11}{16}$	$3\frac{5}{32}$	3	$4\frac{3}{16}$	$2\frac{1}{16}$	1.9370	0.748
$1\frac{3}{4}$	<b>UCFH209-112D1</b>														
50	<b>UCFH210D1</b>	184	58	22	18	40	12	68	46	86	82	112	54.6	51.6	19
$1\frac{13}{16}$	<b>UCFH210-113D1</b>														
$1\frac{7}{8}$	<b>UCFH210-114D1</b>	$7\frac{1}{4}$	$2\frac{9}{32}$	$\frac{55}{64}$	$\frac{23}{32}$	$1\frac{9}{16}$	$\frac{15}{32}$	$2\frac{13}{64}$	$1\frac{13}{16}$	$3\frac{3}{8}$	$3\frac{7}{32}$	$4\frac{13}{32}$	$2\frac{5}{32}$	2.0315	0.748
$1\frac{15}{16}$	<b>UCFH210-115D1</b>														
2	<b>UCFH210-200D1</b>														

Note <sup>(1)</sup> These numbers indicate relubricatable type. If maintenance free type is needed, please order without suffix "D1".

Remarks Please refer to page A21 for size of grease fitting.

<b>Bolt size</b>	<b>Bearing number</b>	<b>Housing number</b>	<b>Mass of unit</b>
<b>mm inch</b>			<b>kg lb</b>
M10	UC208D1	FH208D1	1.8
$\frac{3}{8}$	UC208-108D1	FH208D1	4.0
	UC208-109D1	FH208D1	
M10	UC209D1	FH209D1	2.1
$\frac{3}{8}$	UC209-110D1	FH209D1	4.6
	UC209-111D1	FH209D1	
	UC209-112D1	FH209D1	
M10	UC210D1	FH210D1	2.4
$\frac{3}{8}$	UC210-113D1	FH210D1	5.3
	UC210-114D1	FH210D1	
	UC210-115D1	FH210D1	
	UC210-200D1	FH210D1	

## Light rhombus flanged unit, cast housing Set screw type

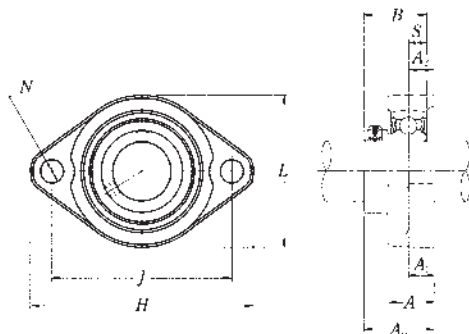

Shaft dia.  mm inch	Unit number (*)	Nominal dimensions										Bolt size  mm inch
		mm inch										
		H	J	A <sub>2</sub>	A <sub>1</sub>	A	N	L	A <sub>0</sub>	B	S	
12 1/2	<b>ASFB201</b>	81	63.5	9.5	9.5	18	7	56	25.5	22	6	M6
	<b>ASFB201-008</b>	3 <sup>3</sup> / <sub>16</sub>	2 <sup>1</sup> / <sub>2</sub>	3/8	3/8	23/32	9/32	2 <sup>7</sup> / <sub>32</sub>	1	0.8661	0.236	1/4
15 9/16 5/8	<b>ASFB202</b>	81	63.5	9.5	9.5	18	7	56	25.5	22	6	M6
	<b>ASFB202-009</b> <b>ASFB202-010</b>	3 <sup>3</sup> / <sub>16</sub>	2 <sup>1</sup> / <sub>2</sub>	3/8	3/8	23/32	9/32	2 <sup>7</sup> / <sub>32</sub>	1	0.8661	0.236	1/4
17 1/2	<b>ASFB203</b>	81	63.5	9.5	9.5	18	7	56	25.5	22	6	M6
	<b>ASFB203-011</b>	3 <sup>3</sup> / <sub>16</sub>	2 <sup>1</sup> / <sub>2</sub>	3/8	3/8	23/32	9/32	2 <sup>7</sup> / <sub>32</sub>	1	0.8661	0.236	1/4
20 3/4	<b>ASFB204</b>	90	71.5	11	11	20	10	61	29	25	7	M8
	<b>ASFB204-012</b>	3 <sup>17</sup> / <sub>32</sub>	2 <sup>13</sup> / <sub>16</sub>	7/16	7/16	25/32	25/64	2 <sup>13</sup> / <sub>32</sub>	1 <sup>9</sup> / <sub>64</sub>	0.9843	0.276	5/16
25 13/16 7/8 15/16 1	<b>ASFB205</b>	95	76	11	11	20	10	64	30.5	27	7.5	M8
	<b>ASFB205-013</b>											
	<b>ASFB205-014</b>	3 <sup>3</sup> / <sub>4</sub>	2 <sup>63</sup> / <sub>64</sub>	7/16	7/16	25/32	25/64	2 <sup>17</sup> / <sub>32</sub>	1 <sup>13</sup> / <sub>64</sub>	1.0630	0.295	5/16
	<b>ASFB205-015</b> <b>ASFB205-100</b>											
30 1 1/16 1 1/8 1 3/16 1 1/4	<b>ASFB206</b>	113	90.5	12	12	22.5	12	76	33	29	8	M10
	<b>ASFB206-101</b>											
	<b>ASFB206-102</b>	4 <sup>7</sup> / <sub>16</sub>	3 <sup>9</sup> / <sub>16</sub>	15/32	15/32	7/8	15/32	3	1 <sup>19</sup> / <sub>64</sub>	1.1417	0.315	3/8
	<b>ASFB206-103</b> <b>ASFB206-104</b>											
35 1 1/4 1 5/16 1 3/8 1 7/16	<b>ASFB207</b>	122	100	11	13	24	12	89	36.5	34	8.5	M10
	<b>ASFB207-104</b>											
	<b>ASFB207-105</b>	4 <sup>13</sup> / <sub>16</sub>	3 <sup>15</sup> / <sub>16</sub>	7/16	1/2	15/16	15/32	3 <sup>1</sup> / <sub>2</sub>	1 <sup>7</sup> / <sub>16</sub>	1.3386	0.335	3/8
	<b>ASFB207-106</b> <b>ASFB207-107</b>											

Note (\*) If relubricatable type is needed, please order with suffix "D1".

Bearing number	Housing number	Mass of unit
		kg lb
AS201	FB201	0.3
AS201-008	FB201	0.7
AS202	FB201	0.3
AS202-009	FB201	0.7
AS202-010	FB201	
AS203	FB201	0.2
AS203-011	FB201	0.4
AS204	FB204	0.3
AS204-012	FB204	0.7
AS205	FB205	0.3
AS205-013	FB205	0.7
AS205-014	FB205	
AS205-015	FB205	
AS205-100	FB205	
AS206	FB206	0.5
AS206-101	FB206	1.1
AS206-102	FB206	
AS206-103	FB206	
AS206-104	FB206	
AS207	FB207	0.8
AS207-104	FB207	1.8
AS207-105	FB207	
AS207-106	FB207	
AS207-107	FB207	

## Light rhombus flanged unit, cast housing Set screw type

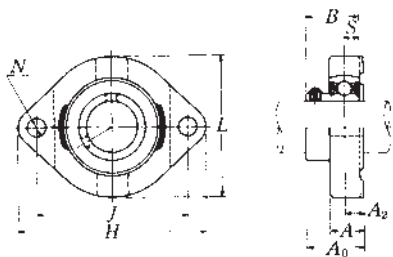

Shaft dia.  mm inch	Unit number (1)	Nominal dimensions									Bolt size  mm inch
		H	J	A <sub>2</sub>	A	N	L	A <sub>0</sub>	B	S	
12  1 2	<b>ASFD201</b>	81	63	8.5	15	7	59	24.5	22	6	M6
	<b>ASFD201-008</b>	3 <sup>3</sup> / <sub>16</sub>	2 <sup>31</sup> / <sub>64</sub>	2 <sup>1</sup> / <sub>64</sub>	19 <sup>1</sup> / <sub>32</sub>	9 <sup>1</sup> / <sub>32</sub>	2 <sup>5</sup> / <sub>16</sub>	3 <sup>1</sup> / <sub>32</sub>	0.8661	0.236	1 <sup>1</sup> / <sub>4</sub>
15  9 16 5 8	<b>ASFD202</b>	81	63	8.5	15	7	59	24.5	22	6	M6
	<b>ASFD202-009</b> <b>ASFD202-010</b>	3 <sup>3</sup> / <sub>16</sub>	2 <sup>31</sup> / <sub>64</sub>	2 <sup>1</sup> / <sub>64</sub>	19 <sup>1</sup> / <sub>32</sub>	9 <sup>1</sup> / <sub>32</sub>	2 <sup>5</sup> / <sub>16</sub>	3 <sup>1</sup> / <sub>32</sub>	0.8661	0.236	1 <sup>1</sup> / <sub>4</sub>
17  11 16	<b>ASFD203</b>	81	63	8.5	15	7	59	24.5	22	6	M6
	<b>ASFD203-011</b>	3 <sup>3</sup> / <sub>16</sub>	2 <sup>31</sup> / <sub>64</sub>	2 <sup>1</sup> / <sub>64</sub>	19 <sup>1</sup> / <sub>32</sub>	9 <sup>1</sup> / <sub>32</sub>	2 <sup>5</sup> / <sub>16</sub>	3 <sup>1</sup> / <sub>32</sub>	0.8661	0.236	1 <sup>1</sup> / <sub>4</sub>
20  3 4	<b>ASFD204</b>	90	71	9.5	17	10	67	27.5	25	7	M8
	<b>ASFD204-012</b>	3 <sup>17</sup> / <sub>32</sub>	2 <sup>51</sup> / <sub>64</sub>	3 <sup>3</sup> / <sub>8</sub>	2 <sup>1</sup> / <sub>32</sub>	2 <sup>5</sup> / <sub>64</sub>	2 <sup>5</sup> / <sub>8</sub>	1 <sup>5</sup> / <sub>64</sub>	0.9843	0.276	5 <sup>1</sup> / <sub>16</sub>
25  13 16 7 8 15 16 1	<b>ASFD205</b>	95	76	9.5	17	10	71	29	27	7.5	M8
	<b>ASFD205-013</b>										
	<b>ASFD205-014</b>	3 <sup>3</sup> / <sub>4</sub>	2 <sup>63</sup> / <sub>64</sub>	3 <sup>3</sup> / <sub>8</sub>	2 <sup>1</sup> / <sub>32</sub>	2 <sup>5</sup> / <sub>64</sub>	2 <sup>25</sup> / <sub>32</sub>	1 <sup>9</sup> / <sub>64</sub>	1.0630	0.295	5 <sup>1</sup> / <sub>16</sub>
	<b>ASFD205-015</b> <b>ASFD205-100</b>										
30  1 16 1 8 1 16 1 4	<b>ASFD206</b>	113	90	12	21	12	84	33	29	8	M10
	<b>ASFD206-101</b>										
	<b>ASFD206-102</b>	4 <sup>7</sup> / <sub>16</sub>	3 <sup>35</sup> / <sub>64</sub>	1 <sup>5</sup> / <sub>32</sub>	1 <sup>3</sup> / <sub>16</sub>	1 <sup>5</sup> / <sub>32</sub>	3 <sup>5</sup> / <sub>16</sub>	1 <sup>19</sup> / <sub>64</sub>	1.1417	0.315	3 <sup>3</sup> / <sub>8</sub>
	<b>ASFD206-103</b> <b>ASFD206-104</b>										
35  1 4 1 16 1 3 8 1 16	<b>ASFD207</b>	125	100	12.5	22	12	94	38	34	8.5	M10
	<b>ASFD207-104</b>										
	<b>ASFD207-105</b>	4 <sup>29</sup> / <sub>32</sub>	3 <sup>15</sup> / <sub>16</sub>	3 <sup>1</sup> / <sub>64</sub>	7 <sup>1</sup> / <sub>8</sub>	1 <sup>5</sup> / <sub>32</sub>	3 <sup>11</sup> / <sub>16</sub>	1 <sup>1</sup> / <sub>2</sub>	1.3386	0.335	3 <sup>3</sup> / <sub>8</sub>
	<b>ASFD207-106</b> <b>ASFD207-107</b>										
40  1 1/2 1 16	<b>ASFD208</b>	148	119	14.5	25	13.5	104	43.5	38	9	M12
	<b>ASFD208-108</b> <b>ASFD208-109</b>	5 <sup>13</sup> / <sub>16</sub>	4 <sup>11</sup> / <sub>16</sub>	3 <sup>7</sup> / <sub>64</sub>	3 <sup>1</sup> / <sub>32</sub>	1 <sup>7</sup> / <sub>32</sub>	4 <sup>3</sup> / <sub>32</sub>	1 <sup>23</sup> / <sub>32</sub>	1.4961	0.354	9 <sup>1</sup> / <sub>16</sub>

Note (1) If relubricatable type is needed, please order with suffix "A-" "D1". Example: A-ASFD201D1

Bearing number	Housing number	Mass of unit
		kg lb
AS201	FD201	0.3
AS201-008	FD201	0.7
AS202	FD201	0.3
AS202-009	FD201	0.7
AS202-010	FD201	
AS203	FD201	0.3
AS203-011	FD201	0.7
AS204	FD204	0.4
AS204-012	FD204	0.9
AS205	FD205	0.5
AS205-013	FD205	
AS205-014	FD205	1.1
AS205-015	FD205	
AS205-100	FD205	
AS206	FD206	0.8
AS206-101	FD206	
AS206-102	FD206	1.8
AS206-103	FD206	
AS206-104	FD206	
AS207	FD207	0.9
AS207-104	FD207	
AS207-105	FD207	2.0
AS207-106	FD207	
AS207-107	FD207	
AS208	FD208	1.3
AS208-108	FD208	2.9
AS208-109	FD208	

## Round flanged unit, pressed steel housing Set screw type

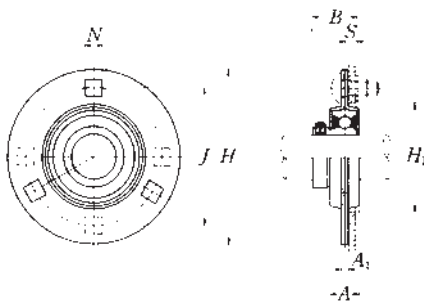

Shaft dia. mm inch	Unit number	Nominal dimensions								Bolt size mm inch
		<i>H</i>	<i>J</i>	<i>A</i> <sub>1</sub>	<i>N</i> <sup>(1)</sup>	<i>A</i>	<i>B</i>	<i>S</i>	<i>H</i> <sub>1</sub> min.	
12 1/2	<b>ASPF201</b> <b>ASPF201-008</b>	81 3 3/16	63.5 2 1/2	4 0.157	7.1 9/32	14 9/16	22 0.8661	6 0.236	49 1 15/16	M6 1/4
15 9/16 5/8	<b>ASPF202</b> <b>ASPF202-009</b> <b>ASPF202-010</b>	81 3 3/16	63.5 2 1/2	4 0.157	7.1 9/32	14 9/16	22 0.8661	6 0.236	49 1 15/16	M6 1/4
17 1 1/16	<b>ASPF203</b> <b>ASPF203-011</b>	81 3 3/16	63.5 2 1/2	4 0.157	7.1 9/32	14 9/16	22 0.8661	6 0.236	49 1 15/16	M6 1/4
20 3/4	<b>ASPF204</b> <b>ASPF204-012</b>	90 3 5/8	71.5 2 13/16	4 0.157	9 23/64	16 5/8	25 0.9843	7 0.276	56 2 7/32	M8 5/16
25 13/16 7/8 15/16 1	<b>ASPF205</b> <b>ASPF205-013</b> <b>ASPF205-014</b> <b>ASPF205-015</b> <b>ASPF205-100</b>	95 3 3/4	76 2 63/64	4 0.157	9 23/64	18 23/32	27 1.0630	7.5 0.295	60 2 3/8	M8 5/16
30 1 1/16 1 1/8 1 3/16 1 1/4	<b>ASPF206</b> <b>ASPF206-101</b> <b>ASPF206-102</b> <b>ASPF206-103</b> <b>ASPF206-104</b>	113 4 1/16	90.5 3 9/16	5.2 0.205	11 7/16	18 23/32	29 1.1417	8 0.315	71 2 13/16	M10 3/8
35 1 1/4 1 5/16 1 3/8 1 7/16	<b>ASPF207</b> <b>ASPF207-104</b> <b>ASPF207-105</b> <b>ASPF207-106</b> <b>ASPF207-107</b>	122 4 13/16	100 3 15/16	5.2 0.205	11 7/16	20 25/32	34 1.3386	8.5 0.335	81 3 3/16	M10 3/8
40 1 1/2 1 9/16	<b>ASPF208</b> <b>ASPF208-108</b> <b>ASPF208-109</b>	148 5 13/16	119 4 11/16	6.8 0.268	13.5 17/32	21 13/16	38 1.4961	9 0.354	91 3 19/32	M12 1/2

Notes (1) ASPF208 has four bolt holes.

(2) The permissible load only applies in applications where the load is stable and the speed is 2400 min<sup>-1</sup> or less.

<b>Max. load <sup>(?)</sup> recommended</b>		<b>Bearing number</b>	<b>Housing number</b>	<b>Mass of unit</b>	
<b>N lbf</b>				<b>kg lb</b>	
radial	axial				
2 700	1 350	AS201	PF203	0.2	
600	300	AS201-008	PF203	0.4	
2 700	1 350	AS202	PF203	0.2	
600	300	AS202-009	PF203	0.4	
		AS202-010	PF203		
2 700	1 350	AS203	PF203	0.2	
600	300	AS203-011	PF203	0.4	
3 000	1 500	AS204	PF204	0.2	
660	330	AS204-012	PF204	0.4	
4 000	2 000	AS205	PF205	0.3	
		AS205-013	PF205		
880	440	AS205-014	PF205	0.7	
		AS205-015	PF205		
		AS205-100	PF205		
5 000	2 500	AS206	PF206	0.4	
		AS206-101	PF206		
1 100	550	AS206-102	PF206	0.9	
		AS206-103	PF206		
		AS206-104	PF206		
6 000	3 000	AS207	PF207	0.6	
		AS207-104	PF207		
1 300	650	AS207-105	PF207	1.3	
		AS207-106	PF207		
		AS207-107	PF207		
7 000	3 500	AS208	PF208	0.9	
1 500	750	AS208-108	PF208	2.0	
		AS208-109	PF208		



## Round flanged unit, pressed steel housing with rubber ring Set screw type

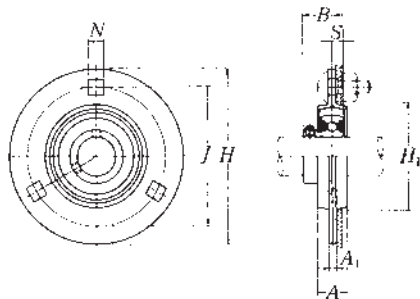

Shaft dia. mm inch	Unit number	Nominal dimensions								Bolt size mm inch
		<i>H</i>	<i>J</i>	<i>A</i> <sub>1</sub>	<i>N</i>	<i>A</i>	<i>B</i>	<i>S</i>	<i>H</i> <sub>1</sub> min.	
12 1/2	<b>ASRPF201</b> <b>ASRPF201-008</b>	90 3 <sup>35</sup> / <sub>64</sub>	71.5 2 <sup>13</sup> / <sub>16</sub>	4 0.157	9 23 <sup>3</sup> / <sub>64</sub>	16 5 <sup>5</sup> / <sub>8</sub>	22 0.8661	6 0.236	56 2 <sup>7</sup> / <sub>32</sub>	M8 5 <sup>5</sup> / <sub>16</sub>
15 9 16 5 8	<b>ASRPF202</b> <b>ASRPF202-009</b> <b>ASRPF202-010</b>	90 3 <sup>35</sup> / <sub>64</sub>	71.5 2 <sup>13</sup> / <sub>16</sub>	4 0.157	9 23 <sup>3</sup> / <sub>64</sub>	16 5 <sup>5</sup> / <sub>8</sub>	22 0.8661	6 0.236	56 2 <sup>7</sup> / <sub>32</sub>	M8 5 <sup>5</sup> / <sub>16</sub>
17 11 16	<b>ASRPF203</b> <b>ASRPF203-011</b>	90 3 <sup>35</sup> / <sub>64</sub>	71.5 2 <sup>13</sup> / <sub>16</sub>	4 0.157	9 23 <sup>3</sup> / <sub>64</sub>	16 5 <sup>5</sup> / <sub>8</sub>	22 0.8661	6 0.236	56 2 <sup>7</sup> / <sub>32</sub>	M8 5 <sup>5</sup> / <sub>16</sub>
20 3 4	<b>ASRPF204</b> <b>ASRPF204-012</b>	95 3 <sup>3</sup> / <sub>4</sub>	76 2 <sup>63</sup> / <sub>64</sub>	4 0.157	9 23 <sup>3</sup> / <sub>64</sub>	18 23 <sup>3</sup> / <sub>32</sub>	25 0.9843	7 0.276	60 2 <sup>3</sup> / <sub>8</sub>	M8 5 <sup>5</sup> / <sub>16</sub>
25 13 16 7 8 15 16 1	<b>ASRPF205</b> <b>ASRPF205-013</b> <b>ASRPF205-014</b> <b>ASRPF205-015</b> <b>ASRPF205-100</b>	113 4 <sup>7</sup> / <sub>16</sub>	90.5 3 <sup>9</sup> / <sub>16</sub>	5.2 0.205	11 7 <sup>7</sup> / <sub>16</sub>	18 23 <sup>3</sup> / <sub>32</sub>	27 1.0630	7.5 0.295	71 2 <sup>13</sup> / <sub>16</sub>	M10 3 <sup>3</sup> / <sub>8</sub>
30 1 16 1 8 1 8 1 16 1 16 1 4	<b>ASRPF206</b> <b>ASRPF206-101</b> <b>ASRPF206-102</b> <b>ASRPF206-103</b> <b>ASRPF206-104</b>	122 4 <sup>13</sup> / <sub>16</sub>	100 3 <sup>15</sup> / <sub>16</sub>	5.2 0.205	11 7 <sup>7</sup> / <sub>16</sub>	20 25 <sup>3</sup> / <sub>32</sub>	29 1.1417	8 0.315	81 3 <sup>3</sup> / <sub>8</sub>	M10 3 <sup>3</sup> / <sub>8</sub>

**Note** (1) The permissible load only applies in applications where the load is stable and the speed is 2400 min<sup>-1</sup> or less.

**Remarks** When an anti-vibration rubber ring is used, the self alignment capability will be reduce.

<b>Max. load (*) recommended</b>		<b>Bearing number</b>	<b>Housing number</b>		<b>Mass of unit</b>
<b>N lbf</b>			rubber ring	steel	
radial	axial				
1 000	200	AS201	R201	PF204	0.2
220	40	AS201-008	R201	PF204	0.4
1 000	200	AS202	R201	PF204	0.2
220	40	AS202-009	R201	PF204	0.4
		AS202-010	R201	PF204	
1 000	200	AS203	R201	PF204	0.2
220	40	AS203-011	R201	PF204	0.4
1 150	200	AS204	R204	PF205	0.2
250	40	AS204-012	R204	PF205	0.4
1 300	200	AS205	R205	PF206	0.3
		AS205-013	R205	PF206	
280	40	AS205-014	R205	PF206	0.7
		AS205-015	R205	PF206	
		AS205-100	R205	PF206	
1 500	200	AS206	R206	PF207	0.5
		AS206-101	R206	PF207	
330	40	AS206-102	R206	PF207	1.1
		AS206-103	R206	PF207	
		AS206-104	R206	PF207	

## Rhombus flanged unit, pressed steel housing Set screw type

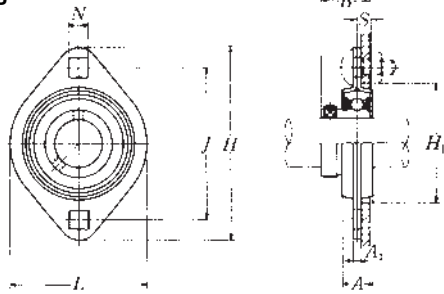

Shaft dia. mm inch	Unit number	Nominal dimensions									Bolt size mm inch
		<i>H</i>	<i>J</i>	<i>A</i> <sub>1</sub>	<i>N</i>	<i>A</i>	<i>L</i>	<i>B</i>	<i>S</i>	<i>H</i> <sub>1</sub> min.	
12 1/2	ASPFL201	81	63.5	4	7.1	14	59	22	6	49	M6
	ASPFL201-008	3 <sup>3</sup> / <sub>16</sub>	2 <sup>1</sup> / <sub>2</sub>	0.157	9 <sup>9</sup> / <sub>32</sub>	9 <sup>9</sup> / <sub>16</sub>	2 <sup>5</sup> / <sub>16</sub>	0.8661	0.236	1 <sup>15</sup> / <sub>16</sub>	1/4
15 9/16 5/8	ASPFL202	81	63.5	4	7.1	14	59	22	6	49	M6
	ASPFL202-009 ASPFL202-010	3 <sup>3</sup> / <sub>16</sub>	2 <sup>1</sup> / <sub>2</sub>	0.157	9 <sup>9</sup> / <sub>32</sub>	9 <sup>9</sup> / <sub>16</sub>	2 <sup>5</sup> / <sub>16</sub>	0.8661	0.236	1 <sup>15</sup> / <sub>16</sub>	1/4
17 11/16	ASPFL203	81	63.5	4	7.1	14	59	22	6	49	M6
	ASPFL203-011	3 <sup>3</sup> / <sub>16</sub>	2 <sup>1</sup> / <sub>2</sub>	0.157	9 <sup>9</sup> / <sub>32</sub>	9 <sup>9</sup> / <sub>16</sub>	2 <sup>5</sup> / <sub>16</sub>	0.8661	0.236	1 <sup>15</sup> / <sub>16</sub>	1/4
20 3/4	ASPFL204	90	71.5	4	9	16	67	25	7	56	M8
	ASPFL204-012	3 <sup>35</sup> / <sub>64</sub>	2 <sup>13</sup> / <sub>16</sub>	0.157	23 <sup>23</sup> / <sub>64</sub>	5 <sup>5</sup> / <sub>8</sub>	2 <sup>5</sup> / <sub>8</sub>	0.9843	0.276	2 <sup>7</sup> / <sub>32</sub>	5/16
25 13/16 7/8 15/16 1	ASPFL205	95	76	4	9	18	71	27	7.5	60	M8
	ASPFL205-013	3 <sup>3</sup> / <sub>4</sub>	2 <sup>63</sup> / <sub>64</sub>	0.157	23 <sup>23</sup> / <sub>64</sub>	23 <sup>23</sup> / <sub>32</sub>	2 <sup>25</sup> / <sub>32</sub>	1.0630	0.295	2 <sup>3</sup> / <sub>8</sub>	5/16
	ASPFL205-014										
	ASPFL205-015										
ASPFL205-100											
30 1 1/16 1 1/8 1 3/16 1 1/4	ASPFL206	113	90.5	5.2	11	18	84	29	8	71	M10
	ASPFL206-101	4 <sup>7</sup> / <sub>16</sub>	3 <sup>9</sup> / <sub>16</sub>	0.205	7 <sup>7</sup> / <sub>16</sub>	23 <sup>23</sup> / <sub>32</sub>	3 <sup>5</sup> / <sub>16</sub>	1.1417	0.315	2 <sup>13</sup> / <sub>16</sub>	3/8
	ASPFL206-102										
	ASPFL206-103										
ASPFL206-104											
35 1 1/4 1 5/16 1 3/8 1 7/16	ASPFL207	122	100	5.2	11	20	94	34	8.5	81	M10
	ASPFL207-104	4 <sup>13</sup> / <sub>16</sub>	3 <sup>15</sup> / <sub>16</sub>	0.205	7 <sup>7</sup> / <sub>16</sub>	25 <sup>25</sup> / <sub>32</sub>	3 <sup>11</sup> / <sub>16</sub>	1.3386	0.335	3 <sup>3</sup> / <sub>16</sub>	3/8
	ASPFL207-105										
	ASPFL207-106										
ASPFL207-107											
40 1 1/2 1 5/16	ASPFL208	148	119	6.8	13.5	21	100	38	9	91	M12
	ASPFL208-108 ASPFL208-109	5 <sup>53</sup> / <sub>64</sub>	4 <sup>11</sup> / <sub>16</sub>	0.268	1 <sup>17</sup> / <sub>32</sub>	53 <sup>53</sup> / <sub>64</sub>	3 <sup>15</sup> / <sub>16</sub>	1.4961	0.354	3 <sup>19</sup> / <sub>32</sub>	1/2

Note (1) The permissible load only applies in applications where the load is stable and the speed is 2400 min<sup>-1</sup> or less.

<b>Max. load (*) recommended</b>		<b>Bearing number</b>	<b>Housing number</b>	<b>Mass of unit</b>	
<b>N lbf</b>				<b>kg lb</b>	
radial	axial				
2 700	1 350	AS201	PFL203	0.2	
600	300	AS201-008	PFL203	0.4	
2 700	1 350	AS202	PFL203	0.2	
600	300	AS202-009	PFL203	0.4	
		AS202-010	PFL203		
2 700	1 350	AS203	PFL203	0.2	
600	300	AS203-011	PFL203	0.4	
3 000	1 500	AS204	PFL204	0.2	
660	330	AS204-012	PFL204	0.4	
4 000	2 000	AS205	PFL205	0.3	
		AS205-013	PFL205		
880	440	AS205-014	PFL205	0.7	
		AS205-015	PFL205		
		AS205-100	PFL205		
5 000	2 500	AS206	PFL206	0.4	
		AS206-101	PFL206		
1 100	550	AS206-102	PFL206	0.9	
		AS206-103	PFL206		
		AS206-104	PFL206		
6 000	3 000	AS207	PFL207	0.6	
		AS207-104	PFL207		
1 300	650	AS207-105	PFL207	1.3	
		AS207-106	PFL207		
		AS207-107	PFL207		
6 000	3 000	AS208	PFL208	0.8	
1 300	650	AS208-108	PFL208	1.8	
		AS208-109	PFL208		

## Hanger unit, cast housing Set screw type

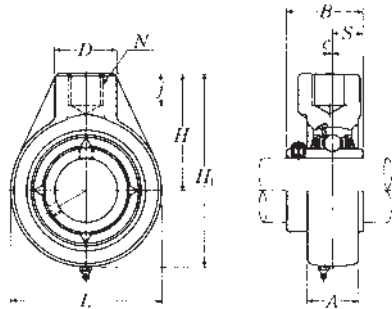

Shaft dia.  mm inch	Unit number (1)	Nominal dimensions									
		mm inch									
		L	H <sub>1</sub>	c	A	H	N	D	j	B	S
12 1/2	UCHB201D1	64	96	0	21	64	Rp 3/4	40	19	31	12.7
	UCHB201-008D1	2 17/32	3 25/32	0	13/16	2 33/64	Rp 3/4	1 9/16	3/4	1.2205	0.500
15 9/16 5/8	UCHB202D1	64	96	0	21	64	Rp 3/4	40	19	31	12.7
	UCHB202-009D1 UCHB202-010D1	2 17/32	3 25/32	0	13/16	2 33/64	Rp 3/4	1 9/16	3/4	1.2205	0.500
17 1 1/16	UCHB203D1	64	96	0	21	64	Rp 3/4	40	19	31	12.7
	UCHB203-011D1	2 17/32	3 25/32	0	13/16	2 33/64	Rp 3/4	1 9/16	3/4	1.2205	0.500
20 3/4	UCHB204D1	64	96	0	21	64	Rp 3/4	40	19	31	12.7
	UCHB204-012D1	2 17/32	3 25/32	0	13/16	2 33/64	Rp 3/4	1 9/16	3/4	1.2205	0.500
25 13/16 7/8 15/16 1	UCHB205D1	78	103	0	24	64	Rp 3/4	40	19	34.1	14.3
	UCHB205-013D1										
	UCHB205-014D1	3 1/16	4 1/16	0	1 5/16	2 33/64	Rp 3/4	1 9/16	3/4	1.3425	0.563
	UCHB205-015D1 UCHB205-100D1										
30 1 1/16 1 1/8 1 3/16 1 1/4	UCHB206D1	78	103	0	28	64	Rp 3/4	40	19	38.1	15.9
	UCHB206-101D1										
	UCHB206-102D1	3 1/16	4 1/16	0	1 3/32	2 33/64	Rp 3/4	1 9/16	3/4	1.5000	0.626
	UCHB206-103D1 UCHB206-104D1										
35 1 1/4 1 5/16 1 3/8 1 1/16	UCHB207D1	92	116	0	30	70	Rp 3/4	40	19	42.9	17.5
	UCHB207-104D1										
	UCHB207-105D1	3 5/8	4 9/16	0	1 3/16	2 3/4	Rp 3/4	1 9/16	3/4	1.6890	0.689
	UCHB207-106D1 UCHB207-107D1										
40 1 1/2 1 9/16	UCHB208D1	96	121	2	33	73	Rp 3/4	40	19	49.2	19
	UCHB208-108D1 UCHB208-109D1	3 25/32	4 3/4	3/32	1 5/16	2 7/8	Rp 3/4	1 9/16	3/4	1.9370	0.748

Note (1) These numbers indicate relubricatable type. If maintenance free type is needed, please order without suffix "D1".

Remarks Please refer to page A21 for size of grease fitting.

Nominal Designation of Thread <i>N</i>	Nominal dimensions mm				
	Major Diameter of Internal Thread	Pitch Diameter	Minor Diameter of Internal Thread	Tolerances	Mounting Bolt size
Rp $\frac{3}{4}$ (PS $\frac{3}{4}$ )	26.441	25.279	24.117	±0.142	R $\frac{3}{4}$ (PT $\frac{3}{4}$ )
Rp1(PS1)	33.249	31.770	30.291	±0.181	R1(PT1)
Rp1 $\frac{1}{4}$ (PS1 $\frac{1}{4}$ )	41.910	40.431	38.952	±0.181	R1 $\frac{1}{4}$ (PT1 $\frac{1}{4}$ )
Rp1 $\frac{1}{2}$ (PS1 $\frac{1}{2}$ )	47.803	46.324	44.845	±0.181	R1 $\frac{1}{2}$ (PT1 $\frac{1}{2}$ )

Bearing number	Housing number	Mass of unit	
		kg	lb
UC201D1	HB204D1	1.0	
UC201-008D1	HB204D1	2.2	
UC202D1	HB204D1	0.9	
UC202-009D1	HB204D1	2.0	
UC202-010D1	HB204D1		
UC203D1	HB204D1	0.9	
UC203-011D1	HB204D1	2.0	
UC204D1	HB204D1	0.9	
UC204-012D1	HB204D1	2.0	
UC205D1	HB205D1	0.9	
UC205-013D1	HB205D1		
UC205-014D1	HB205D1	2.0	
UC205-015D1	HB205D1		
UC205-100D1	HB205D1		
UC206D1	HB206D1	0.8	
UC206-101D1	HB206D1		
UC206-102D1	HB206D1	1.8	
UC206-103D1	HB206D1		
UC206-104D1	HB206D1		
UC207D1	HB207D1	1.2	
UC207-104D1	HB207D1		
UC207-105D1	HB207D1	2.6	
UC207-106D1	HB207D1		
UC207-107D1	HB207D1		
UC208D1	HB208D1	1.3	
UC208-108D1	HB208D1	2.9	
UC208-109D1	HB208D1		

# UCHB2

## Hanger unit, cast housing Set screw type

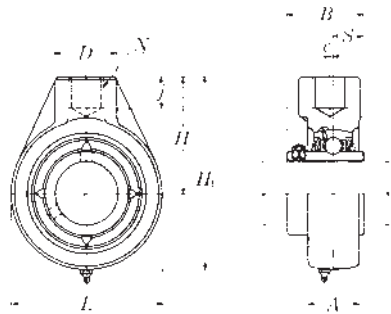

Shaft dia. mm inch	Unit number (1)	Nominal dimensions									
		mm inch									
		L	H <sub>1</sub>	c	A	H	N	D	j	B	S
45	<b>UCHB209D1</b>	108	136	5	35	82	Rp1	48	21	49.2	19
1 5/8	<b>UCHB209-110D1</b>										
1 1/16	<b>UCHB209-111D1</b>	4 1/4	5 11/32	3/16	1 3/8	3 15/64	Rp1	1 7/8	1 3/16	1.9370	0.748
1 3/4	<b>UCHB209-112D1</b>										
50	<b>UCHB210D1</b>	118	142	5	37	83	Rp1	48	21	51.6	19
1 3/8	<b>UCHB210-113D1</b>										
1 7/8	<b>UCHB210-114D1</b>	4 21/32	5 19/32	3/16	1 15/32	3 17/64	Rp1	1 7/8	1 3/16	2.0315	0.748
1 5/16	<b>UCHB210-115D1</b>										
2	<b>UCHB210-200D1</b>										
55	<b>UCHB211D1</b>	126	158	7	38	95	Rp1 1/4	60	25	55.6	22.2
2	<b>UCHB211-200D1</b>										
2 1/16	<b>UCHB211-201D1</b>	4 31/32	6 7/32	9/32	1 1/2	3 47/64	Rp1 1/4	2 3/8	3 1/32	2.1890	0.874
2 1/8	<b>UCHB211-202D1</b>										
2 3/16	<b>UCHB211-203D1</b>										
60	<b>UCHB212D1</b>	142	173	9	42	102	Rp1 1/4	60	28	65.1	25.4
2 1/4	<b>UCHB212-204D1</b>										
2 1/16	<b>UCHB212-205D1</b>	5 19/32	6 13/16	1 1/32	1 21/32	4 1/64	Rp1 1/4	2 3/8	1 3/32	2.5630	1.000
2 3/8	<b>UCHB212-206D1</b>										
2 1/16	<b>UCHB212-207D1</b>										
65	<b>UCHB213D1</b>	166	200	9.5	44	117	Rp1 1/2	70	32	65.1	25.4
2 1/2	<b>UCHB213-208D1</b>	6 17/32	7 7/8	3/8	1 25/32	4 39/64	Rp1 1/2	2 3/4	1 1/4	2.5630	1.000

Note (1) These numbers indicate relubricatable type. If maintenance free type is needed, please order without suffix "D1".

Remarks Please refer to page A21 for size of grease fitting.

Nominal Designation of Thread <i>N</i>	Nominal dimensions mm				
	Major Diameter of Internal Thread	Pitch Diameter	Minor Diameter of Internal Thread	Tolerances	Mounting Bolt size
Rp $\frac{3}{4}$ (PS $\frac{3}{4}$ )	26.441	25.279	24.117	±0.142	R $\frac{3}{4}$ (PT $\frac{3}{4}$ )
Rp1(PS1)	33.249	31.770	30.291	±0.181	R1 (PT1)
Rp1 $\frac{1}{4}$ (PS1 $\frac{1}{4}$ )	41.910	40.431	38.952	±0.181	R1 $\frac{1}{4}$ (PT1 $\frac{1}{4}$ )
Rp1 $\frac{1}{2}$ (PS1 $\frac{1}{2}$ )	47.803	46.324	44.845	±0.181	R1 $\frac{1}{2}$ (PT1 $\frac{1}{2}$ )

Bearing number	Housing number	Mass of unit	
		kg	lb
UC209D1	HB209D1	1.8	
UC209-110D1	HB209D1		
UC209-111D1	HB209D1	4.0	
UC209-112D1	HB209D1		
UC210D1	HB210D1	2.2	
UC210-113D1	HB210D1		
UC210-114D1	HB210D1	4.9	
UC210-115D1	HB210D1		
UC210-200D1	HB210D1		
UC211D1	HB211D1	2.8	
UC211-200D1	HB211D1		
UC211-201D1	HB211D1	6.2	
UC211-202D1	HB211D1		
UC211-203D1	HB211D1		
UC212D1	HB212D1	3.7	
UC212-204D1	HB212D1		
UC212-205D1	HB212D1	8.2	
UC212-206D1	HB212D1		
UC212-207D1	HB212D1		
UC213D1	HB213D1	5.7	
UC213-208D1	HB213D1	13	



## Take-up unit, cast housing Set screw type

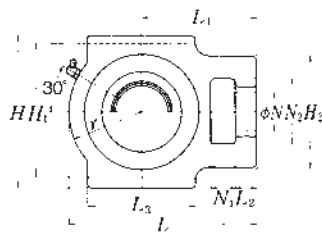
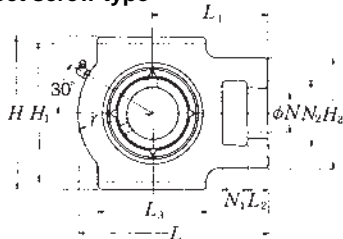

Pressed steel dust cover type  
Open end **Z-UCT...D1**  
Closed end **ZM-UCT...D1**

Shaft dia. mm inch	Unit number (1)	Nominal dimensions															
		mm inch															
		$N_1$	$L_2$	$H_2$	$N_2$	$N$	$L_3$	$A_1$	$H_1$	$H$	$L$	$A_2$	$A$	$r$	$L_1$	$B$	$S$
12 1/2	<b>UCT201D1</b>	16	12	51	32	19	51	12	76	89	94	21	32	33	61	31	12.7
	<b>UCT201-008D1</b>	5/8	15/32	2	1 1/4	3/4	2	0.472	2 63/64	3 1/2	3 11/16	13/16	1 1/4	1 5/16	2 13/32	1.2205	0.500
15 9/16 5/8	<b>UCT202D1</b>	16	12	51	32	19	51	12	76	89	94	21	32	33	61	31	12.7
	<b>UCT202-009D1</b> <b>UCT202-010D1</b>	5/8	15/32	2	1 1/4	3/4	2	0.472	2 63/64	3 1/2	3 11/16	13/16	1 1/4	1 5/16	2 13/32	1.2205	0.500
17 1 1/16	<b>UCT203D1</b>	16	12	51	32	19	51	12	76	89	94	21	32	33	61	31	12.7
	<b>UCT203-011D1</b>	5/8	15/32	2	1 1/4	3/4	2	0.472	2 63/64	3 1/2	3 11/16	13/16	1 1/4	1 5/16	2 13/32	1.2205	0.500
20 3/4	<b>UCT204D1</b>	16	12	51	32	19	51	12	76	89	94	21	32	33	61	31	12.7
	<b>UCT204-012D1</b>	5/8	15/32	2	1 1/4	3/4	2	0.472	2 63/64	3 1/2	3 11/16	13/16	1 1/4	1 5/16	2 13/32	1.2205	0.500
25 13/16 7/8 15/16 1	<b>UCT205D1</b>	16	12	51	32	19	51	12	76	89	97	24	32	35	62	34.1	14.3
	<b>UCT205-013D1</b>																
	<b>UCT205-014D1</b>	5/8	15/32	2	1 1/4	3/4	2	0.472	2 63/64	3 1/2	3 3/16	15/16	1 1/4	1 3/8	2 7/16	1.3425	0.563
	<b>UCT205-015D1</b> <b>UCT205-100D1</b>																
30 1 1/16 1 1/8 1 3/16 1 1/4	<b>UCT206D1</b>	16	12	56	37	22	57	12	89	102	113	28	37	43	70	38.1	15.9
	<b>UCT206-101D1</b>																
	<b>UCT206-102D1</b>	5/8	15/32	2 7/32	1 15/32	7/8	2 1/4	0.472	3 1/2	4 1/32	4 7/16	1 3/32	1 15/32	1 11/16	2 3/4	1.5000	0.626
	<b>UCT206-103D1</b> <b>UCT206-104D1</b>																
35 1 1/4 1 5/16 1 3/8 1 1/2	<b>UCT207D1</b>	16	15	64	37	22	64	12	89	102	129	30	37	51	78	42.9	17.5
	<b>UCT207-104D1</b>																
	<b>UCT207-105D1</b>	5/8	19/32	2 17/32	1 15/32	7/8	2 17/32	0.472	3 1/2	4 1/32	5 3/32	1 3/16	1 15/32	2	3 1/16	1.6890	0.689
	<b>UCT207-106D1</b>																
	<b>UCT207-107D1</b>																
40 1 1/2 1 5/8	<b>UCT208D1</b>	19	18	83	49	29	83	16	102	114	144	33	49	56	88	49.2	19
	<b>UCT208-108D1</b> <b>UCT208-109D1</b>	3/4	23/32	3 9/32	1 15/16	1 5/32	3 3/32	0.630	4 1/64	4 1/2	5 21/32	1 5/16	1 15/16	2 7/32	3 15/32	1.9370	0.748

Note (1) These numbers indicate relubricatable type. If maintenance free type is needed, please order without suffix "D1".

Remarks Please refer to page A21 for size of grease fitting.

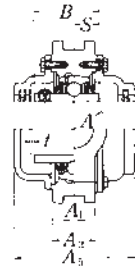
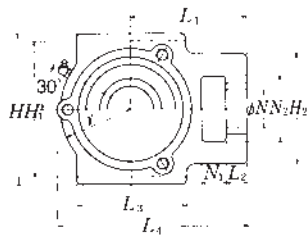

Cast dust cover type  
Open end **C-UCT--D1**  
Closed end **CM-UCT--D1**

Bearing number	Housing number	Unit number (1) pressed steel dust cover type	Unit number (1) cast dust cover type	Nominal dimensions				Mass of unit		
				mm		inch		kg lb		
				t max.	A <sub>4</sub>	L <sub>4</sub>	A <sub>5</sub>	UCT	Z(ZM)	C(CM)
UC201D1	T204D1	Z(ZM)-UCT201D1	C(CM)-UCT201D1	2	45	97	62	0.6	0.8	1.1
UC201-008D1	T204D1	Z(ZM)-UCT201-008D1	C(CM)-UCT201-008D1	5/64	1 <sup>25</sup> / <sub>32</sub>	3 <sup>13</sup> / <sub>16</sub>	2 <sup>7</sup> / <sub>16</sub>	1.3	1.8	2.4
UC202D1	T204D1	Z(ZM)-UCT202D1	C(CM)-UCT202D1	2	45	97	62	0.6	0.8	1.1
UC202-009D1	T204D1	Z(ZM)-UCT202-009D1	C(CM)-UCT202-009D1	5/64	1 <sup>25</sup> / <sub>32</sub>	3 <sup>13</sup> / <sub>16</sub>	2 <sup>7</sup> / <sub>16</sub>	1.3	1.8	2.4
UC202-010D1	T204D1	Z(ZM)-UCT202-010D1	C(CM)-UCT202-010D1	5/64	1 <sup>25</sup> / <sub>32</sub>	3 <sup>13</sup> / <sub>16</sub>	2 <sup>7</sup> / <sub>16</sub>	1.3	1.8	2.4
UC203D1	T204D1	Z(ZM)-UCT203D1	C(CM)-UCT203D1	2	45	97	62	0.6	0.8	1.0
UC203-011D1	T204D1	Z(ZM)-UCT203-011D1	C(CM)-UCT203-011D1	5/64	1 <sup>35</sup> / <sub>32</sub>	3 <sup>13</sup> / <sub>16</sub>	2 <sup>7</sup> / <sub>16</sub>	1.3	1.8	2.2
UC204D1	T204D1	Z(ZM)-UCT204D1	C(CM)-UCT204D1	2	45	97	62	0.6	0.8	1.0
UC204-012D1	T204D1	Z(ZM)-UCT204-012D1	C(CM)-UCT204-012D1	5/64	1 <sup>25</sup> / <sub>32</sub>	3 <sup>13</sup> / <sub>16</sub>	2 <sup>7</sup> / <sub>16</sub>	1.3	1.8	2.2
UC205D1	T205D1	Z(ZM)-UCT205D1	C(CM)-UCT205D1	2	48	100.5	70	0.8	0.9	1.1
UC205-013D1	T205D1	Z(ZM)-UCT205-013D1	C(CM)-UCT205-013D1	5/64	1 <sup>29</sup> / <sub>32</sub>	3 <sup>31</sup> / <sub>32</sub>	2 <sup>3</sup> / <sub>4</sub>	1.8	2.0	2.4
UC205-014D1	T205D1	Z(ZM)-UCT205-014D1	C(CM)-UCT205-014D1	5/64	1 <sup>29</sup> / <sub>32</sub>	3 <sup>31</sup> / <sub>32</sub>	2 <sup>3</sup> / <sub>4</sub>	1.8	2.0	2.4
UC205-015D1	T205D1	Z(ZM)-UCT205-015D1	C(CM)-UCT205-015D1	5/64	1 <sup>29</sup> / <sub>32</sub>	3 <sup>31</sup> / <sub>32</sub>	2 <sup>3</sup> / <sub>4</sub>	1.8	2.0	2.4
UC205-100D1	T205D1	Z(ZM)-UCT205-100D1	C(CM)-UCT205-100D1	5/64	1 <sup>29</sup> / <sub>32</sub>	3 <sup>31</sup> / <sub>32</sub>	2 <sup>3</sup> / <sub>4</sub>	1.8	2.0	2.4
UC206D1	T206D1	Z(ZM)-UCT206D1	C(CM)-UCT206D1	2	53	113.5	75	1.3	1.3	1.7
UC206-101D1	T206D1	Z(ZM)-UCT206-101D1	C(CM)-UCT206-101D1	5/64	2 <sup>3</sup> / <sub>32</sub>	4 <sup>15</sup> / <sub>32</sub>	2 <sup>15</sup> / <sub>16</sub>	2.9	2.9	3.7
UC206-102D1	T206D1	Z(ZM)-UCT206-102D1	C(CM)-UCT206-102D1	5/64	2 <sup>3</sup> / <sub>32</sub>	4 <sup>15</sup> / <sub>32</sub>	2 <sup>15</sup> / <sub>16</sub>	2.9	2.9	3.7
UC206-103D1	T206D1	Z(ZM)-UCT206-103D1	C(CM)-UCT206-103D1	5/64	2 <sup>3</sup> / <sub>32</sub>	4 <sup>15</sup> / <sub>32</sub>	2 <sup>15</sup> / <sub>16</sub>	2.9	2.9	3.7
UC206-104D1	T206D1	-	C(CM)-UCT206-104D1	5/64	2 <sup>3</sup> / <sub>32</sub>	4 <sup>15</sup> / <sub>32</sub>	2 <sup>15</sup> / <sub>16</sub>	2.9	2.9	3.7
UC207D1	T207D1	Z(ZM)-UCT207D1	C(CM)-UCT207D1	3	60	129	80	1.6	1.7	2.1
UC207-104D1	T207D1	Z(ZM)-UCT207-104D1	C(CM)-UCT207-104D1	1/8	2 <sup>1</sup> / <sub>32</sub>	5 <sup>3</sup> / <sub>32</sub>	3 <sup>5</sup> / <sub>32</sub>	3.5	3.7	4.6
UC207-105D1	T207D1	Z(ZM)-UCT207-105D1	C(CM)-UCT207-105D1	1/8	2 <sup>1</sup> / <sub>32</sub>	5 <sup>3</sup> / <sub>32</sub>	3 <sup>5</sup> / <sub>32</sub>	3.5	3.7	4.6
UC207-106D1	T207D1	Z(ZM)-UCT207-106D1	C(CM)-UCT207-106D1	1/8	2 <sup>1</sup> / <sub>32</sub>	5 <sup>3</sup> / <sub>32</sub>	3 <sup>5</sup> / <sub>32</sub>	3.5	3.7	4.6
UC207-107D1	T207D1	-	C(CM)-UCT207-107D1	1/8	2 <sup>1</sup> / <sub>32</sub>	5 <sup>3</sup> / <sub>32</sub>	3 <sup>5</sup> / <sub>32</sub>	3.5	3.7	4.6
UC208D1	T208D1	Z(ZM)-UCT208D1	C(CM)-UCT208D1	3	69	144	90	2.4	2.5	3.1
UC208-108D1	T208D1	Z(ZM)-UCT208-108D1	C(CM)-UCT208-108D1	1/8	2 <sup>23</sup> / <sub>32</sub>	5 <sup>21</sup> / <sub>32</sub>	3 <sup>17</sup> / <sub>32</sub>	5.3	5.5	6.8
UC208-109D1	T208D1	Z(ZM)-UCT208-109D1	C(CM)-UCT208-109D1	1/8	2 <sup>23</sup> / <sub>32</sub>	5 <sup>21</sup> / <sub>32</sub>	3 <sup>17</sup> / <sub>32</sub>	5.3	5.5	6.8

## Take-up unit, cast housing Set screw type

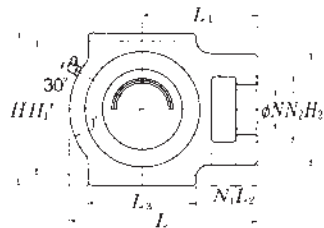
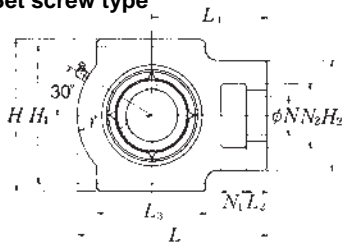

Pressed steel dust cover type  
Open end **Z-UCT...D1**  
Closed end **ZM-UCT...D1**

Shaft dia. mm inch	Unit number (1)	Nominal dimensions															
		mm inch															
		$N_1$	$L_2$	$H_2$	$N_2$	$N$	$L_3$	$A_1$	$H_1$	$H$	$L$	$A_2$	$A$	$r$	$L_1$	$B$	$S$
45 1 5/8 1 1/16 1 1/4	<b>UCT209D1</b> <b>UCT209-110D1</b> <b>UCT209-111D1</b> <b>UCT209-112D1</b>	19	18	83	49	29	83	16	102	117	145	35	49	57	88	49.2	19
		3/4	23/32	3 9/32	1 15/16	1 5/32	3 9/32	0.630	4 1/64	4 19/32	5 23/32	1 3/8	1 15/16	2 1/4	3 15/32	1.9370	0.748
50 1 3/8 1 7/8 1 5/16 2	<b>UCT210D1</b> <b>UCT210-113D1</b> <b>UCT210-114D1</b> <b>UCT210-115D1</b> <b>UCT210-200D1</b>	19	18	83	49	29	86	16	102	117	151	37	49	59	92	51.6	19
		3/4	23/32	3 9/32	1 15/16	1 5/32	3 3/8	0.630	4 1/64	4 19/32	5 15/16	1 15/32	1 15/16	2 5/16	3 5/8	2.0315	0.748
55 2 2 1/16 2 1/8 2 3/16	<b>UCT211D1</b> <b>UCT211-200D1</b> <b>UCT211-201D1</b> <b>UCT211-202D1</b> <b>UCT211-203D1</b>	25	21	102	64	35	95	22	130	146	171	38	64	65	106	55.6	22.2
		3 1/32	1 3/16	4 1/32	2 17/32	1 3/8	3 3/4	0.866	5 1/8	5 3/4	6 23/32	1 1/2	2 17/32	2 9/16	4 3/16	2.1890	0.874
60 2 1/4 2 5/16 2 3/8 2 7/16	<b>UCT212D1</b> <b>UCT212-204D1</b> <b>UCT212-205D1</b> <b>UCT212-206D1</b> <b>UCT212-207D1</b>	32	21	102	64	35	102	22	130	146	194	42	64	75	119	65.1	25.4
		1 1/4	1 3/16	4 1/32	2 17/32	1 3/8	4 1/32	0.866	5 1/8	5 3/4	7 5/8	1 21/32	2 17/32	2 15/16	4 11/16	2.5630	1.000
65 2 1/2 2 7/16	<b>UCT213D1</b> <b>UCT213-208D1</b> <b>UCT213-209D1</b>	32	23	111	70	41	121	26	151	167	224	44	70	87	137	65.1	25.4
		1 1/4	29/32	4 3/8	2 3/4	1 5/8	4 3/4	1.024	5 15/16	6 9/16	8 13/16	1 23/32	2 3/4	3 7/16	5 13/32	2.5630	1.000
70 2 5/8 2 1/16 2 3/4	<b>UCT214D1</b> <b>UCT214-210D1</b> <b>UCT214-211D1</b> <b>UCT214-212D1</b>	32	23	111	70	41	121	26	151	167	224	46	70	87	137	74.6	30.2
		1 1/4	29/32	4 3/8	2 3/4	1 5/8	4 3/4	1.024	5 15/16	6 9/16	8 13/16	1 13/16	2 3/4	3 7/16	5 13/32	2.9370	1.189

Note (1) These numbers indicate relubricatable type. If maintenance free type is needed, please order without suffix "D1".

Remarks Please refer to page A21 for size of grease fitting.

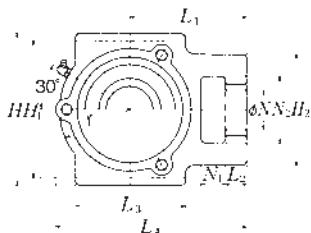

Cast dust cover type  
 Open end **C-UCT---D1**  
 Closed end **CM-UCT---D1**

Bearing number	Housing number	Unit number (1) pressed steel dust cover type	Unit number (1) cast dust cover type	Nominal dimensions				Mass of unit		
				mm		inch		kg lb		
				t max.	A <sub>4</sub>	L <sub>4</sub>	A <sub>5</sub>	UCT	Z(ZM)	C(CM)
UC209D1	T209D1	Z(ZM)-UCT209D1	C(CM)-UCT209D1	3	69	145.5	95	2.4	2.5	3.3
UC209-110D1	T209D1	Z(ZM)-UCT209-110D1	C(CM)-UCT209-110D1							
UC209-111D1	T209D1	Z(ZM)-UCT209-111D1	C(CM)-UCT209-111D1	1/8	2 <sup>23</sup> / <sub>32</sub>	5 <sup>23</sup> / <sub>32</sub>	3 <sup>3</sup> / <sub>4</sub>	5.3	5.5	7.3
UC209-112D1	T209D1	Z(ZM)-UCT209-112D1	C(CM)-UCT209-112D1							
UC210D1	T210D1	Z(ZM)-UCT210D1	C(CM)-UCT210D1	3	76	152	100	2.6	2.7	3.6
UC210-113D1	T210D1	Z(ZM)-UCT210-113D1	C(CM)-UCT210-113D1							
UC210-114D1	T210D1	Z(ZM)-UCT210-114D1	C(CM)-UCT210-114D1							
UC210-115D1	T210D1	Z(ZM)-UCT210-115D1	C(CM)-UCT210-115D1	1/8	3	5 <sup>31</sup> / <sub>32</sub>	3 <sup>15</sup> / <sub>16</sub>	5.7	6.0	7.9
UC210-200D1	T210D1	—	C(CM)-UCT210-200D1							
UC211D1	T211D1	Z(ZM)-UCT211D1	C(CM)-UCT211D1	4	77	171.5	100	3.9	4.1	5.0
UC211-200D1	T211D1	Z(ZM)-UCT211-200D1	C(CM)-UCT211-200D1							
UC211-201D1	T211D1	Z(ZM)-UCT211-201D1	C(CM)-UCT211-201D1							
UC211-202D1	T211D1	Z(ZM)-UCT211-202D1	C(CM)-UCT211-202D1	5/32	3 <sup>1</sup> / <sub>2</sub>	6 <sup>3</sup> / <sub>4</sub>	3 <sup>15</sup> / <sub>16</sub>	8.6	9.0	11
UC211-203D1	T211D1	Z(ZM)-UCT211-203D1	C(CM)-UCT211-203D1							
UC212D1	T212D1	Z(ZM)-UCT212D1	C(CM)-UCT212D1	4	89	194	115	4.8	5.1	6.1
UC212-204D1	T212D1	Z(ZM)-UCT212-204D1	C(CM)-UCT212-204D1							
UC212-205D1	T212D1	Z(ZM)-UCT212-205D1	C(CM)-UCT212-205D1							
UC212-206D1	T212D1	Z(ZM)-UCT212-206D1	C(CM)-UCT212-206D1	5/32	3 <sup>1</sup> / <sub>2</sub>	7 <sup>5</sup> / <sub>8</sub>	4 <sup>17</sup> / <sub>32</sub>	11	11	13
UC212-207D1	T212D1	—	C(CM)-UCT212-207D1							
UC213D1	T213D1	Z(ZM)-UCT213D1	C(CM)-UCT213D1	4	91	224	120	7.0	7.3	8.4
UC213-208D1	T213D1	Z(ZM)-UCT213-208D1	C(CM)-UCT213-208D1							
UC213-209D1	T213D1	Z(ZM)-UCT213-209D1	C(CM)-UCT213-209D1	5/32	3 <sup>19</sup> / <sub>32</sub>	8 <sup>19</sup> / <sub>16</sub>	4 <sup>23</sup> / <sub>32</sub>	15	16	19
UC214D1	T214D1	—	C(CM)-UCT214D1	4	—	224	135	7.0	—	9.1
UC214-210D1	T214D1	—	C(CM)-UCT214-201D1							
UC214-211D1	T214D1	—	C(CM)-UCT214-211D1	5/32	—	8 <sup>13</sup> / <sub>16</sub>	5 <sup>5</sup> / <sub>16</sub>	15	—	20
UC214-212D1	T214D1	—	C(CM)-UCT214-212D1							

## Take-up unit, cast housing Set screw type

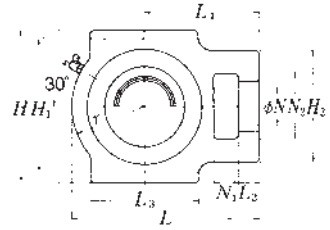
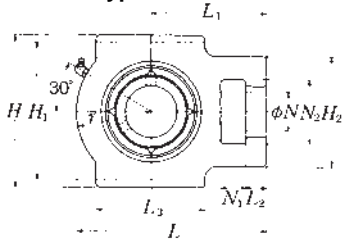

Pressed steel dust cover type  
Open end **Z-UCT...D1**  
Closed end **ZM-UCT...D1**

Shaft dia. mm inch	Unit number (1)	Nominal dimensions															
		mm inch															
		$N_1$	$L_2$	$H_2$	$N_2$	$N$	$L_3$	$A_1$	$H_1$	$H$	$L$	$A_2$	$A$	$r$	$L_1$	$B$	$S$
75 2 <sup>3</sup> / <sub>16</sub> 2 <sup>7</sup> / <sub>8</sub> 2 <sup>5</sup> / <sub>16</sub> 3	<b>UCT215D1</b> <b>UCT215-213D1</b> <b>UCT215-214D1</b> <b>UCT215-215D1</b> <b>UCT215-300D1</b>	32	23	111	70	41	121	26	151	167	232	48	70	92	140	77.8	33.3
		1 <sup>1</sup> / <sub>4</sub>	<sup>29</sup> / <sub>32</sub>	4 <sup>3</sup> / <sub>8</sub>	2 <sup>3</sup> / <sub>4</sub>	1 <sup>5</sup> / <sub>8</sub>	4 <sup>3</sup> / <sub>4</sub>	1.024	5 <sup>15</sup> / <sub>16</sub>	6 <sup>9</sup> / <sub>16</sub>	9 <sup>1</sup> / <sub>8</sub>	1 <sup>7</sup> / <sub>8</sub>	2 <sup>3</sup> / <sub>4</sub>	3 <sup>5</sup> / <sub>8</sub>	5 <sup>1</sup> / <sub>2</sub>	3.0630	1.311
80 3 <sup>1</sup> / <sub>16</sub> 3 <sup>3</sup> / <sub>8</sub> 3 <sup>5</sup> / <sub>16</sub>	<b>UCT216D1</b> <b>UCT216-301D1</b> <b>UCT216-302D1</b> <b>UCT216-303D1</b>	32	23	111	70	41	121	26	165	184	235	51	70	95	140	82.6	33.3
		1 <sup>1</sup> / <sub>4</sub>	<sup>29</sup> / <sub>32</sub>	4 <sup>3</sup> / <sub>8</sub>	2 <sup>3</sup> / <sub>4</sub>	1 <sup>5</sup> / <sub>8</sub>	4 <sup>3</sup> / <sub>4</sub>	1.024	6 <sup>1</sup> / <sub>2</sub>	7 <sup>1</sup> / <sub>4</sub>	9 <sup>1</sup> / <sub>4</sub>	2	2 <sup>3</sup> / <sub>4</sub>	3 <sup>3</sup> / <sub>4</sub>	5 <sup>1</sup> / <sub>2</sub>	3.2520	1.311
85 3 <sup>3</sup> / <sub>4</sub> 3 <sup>5</sup> / <sub>16</sub> 3 <sup>7</sup> / <sub>16</sub>	<b>UCT217D1</b> <b>UCT217-304D1</b> <b>UCT217-305D1</b> <b>UCT217-307D1</b>	38	31	124	73	48	157	30	173	198	260	54	73	98	162	85.7	34.1
		1 <sup>1</sup> / <sub>2</sub>	1 <sup>7</sup> / <sub>32</sub>	4 <sup>7</sup> / <sub>8</sub>	2 <sup>7</sup> / <sub>8</sub>	1 <sup>7</sup> / <sub>8</sub>	6 <sup>3</sup> / <sub>16</sub>	1.181	6 <sup>13</sup> / <sub>16</sub>	7 <sup>25</sup> / <sub>32</sub>	10 <sup>1</sup> / <sub>4</sub>	2 <sup>1</sup> / <sub>8</sub>	2 <sup>7</sup> / <sub>8</sub>	3 <sup>27</sup> / <sub>32</sub>	6 <sup>3</sup> / <sub>8</sub>	3.3740	1.343

Note (1) These numbers indicate relubricatable type. If maintenance free type is needed, please order without suffix "D1".

Remarks Please refer to page A21 for size of grease fitting.

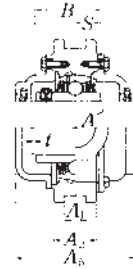
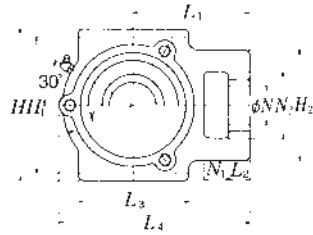

Cast dust cover type  
 Open end **C-UCT--D1**  
 Closed end **CM-UCT--D1**

Bearing number	Housing number	Unit number (1) pressed steel dust cover type	Unit number (1) cast dust cover type	Nominal dimensions				Mass of unit		
				mm		inch		kg lb		
				t max.	A <sub>4</sub>	L <sub>4</sub>	A <sub>5</sub>	UCT	Z(ZM)	C(CM)
UC215D1	T215D1	—	<b>C(CM)-UCT215D1</b>	4	—	232	135	7.4	—	9.8
UC215-213D1	T215D1	—	<b>C(CM)-UCT215-213D1</b>	5/32	—	9 1/8	5 5/16	16	—	22
UC215-214D1	T215D1		<b>C(CM)-UCT215-214D1</b>							
UC215-215D1	T215D1		<b>C(CM)-UCT215-215D1</b>							
UC215-300D1	T215D1		<b>C(CM)-UCT215-300D1</b>							
UC216D1	T216D1	—	<b>C(CM)-UCT216D1</b>	4	—	235	145	8.2	—	11
UC216-301D1	T216D1	—	<b>C(CM)-UCT216-301D1</b>	5/32	—	9 1/4	5 23/32	18	—	24
UC216-302D1	T216D1		<b>C(CM)-UCT216-302D1</b>							
UC216-303D1	T216D1		<b>C(CM)-UCT216-303D1</b>							
UC217D1	T217D1	—	<b>C(CM)-UCT217D1</b>	5	—	260	155	11	—	14
UC217-304D1	T217D1	—	<b>C(CM)-UCT217-304D1</b>	13/64	—	10 1/4	6 3/32	24	—	31
UC217-305D1	T217D1		<b>C(CM)-UCT217-305D1</b>							
UC217-307D1	T217D1		<b>C(CM)-UCT217-307D1</b>							

## Take-up unit, cast housing Set screw type

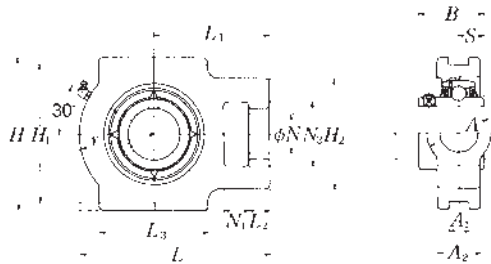

Shaft dia. mm inch	Unit number (1)	Nominal dimensions															
		mm inch															
		$N_1$	$L_2$	$H_2$	$N_2$	$N$	$L_3$	$A_1$	$H_1$	$H$	$L$	$A_2$	$A$	$r$	$L_1$	$B$	$S$
25 1 <sup>13</sup> / <sub>16</sub> 7 <sup>7</sup> / <sub>8</sub> 1 <sup>15</sup> / <sub>16</sub> 1	<b>UCT305D1</b> <b>UCT305-013D1</b> <b>UCT305-014D1</b> <b>UCT305-015D1</b> <b>UCT305-100D1</b>	16	14	62	36	26	65	12	80	89	122	26	36	46	76	38	15
		5 <sup>5</sup> / <sub>8</sub>	9 <sup>9</sup> / <sub>16</sub>	2 <sup>7</sup> / <sub>16</sub>	1 <sup>13</sup> / <sub>32</sub>	1 <sup>1</sup> / <sub>32</sub>	2 <sup>9</sup> / <sub>16</sub>	0.472	3 <sup>5</sup> / <sub>32</sub>	3 <sup>1</sup> / <sub>2</sub>	4 <sup>13</sup> / <sub>16</sub>	1 <sup>1</sup> / <sub>32</sub>	1 <sup>13</sup> / <sub>32</sub>	1 <sup>13</sup> / <sub>16</sub>	3	1.4961	0.591
30 1 <sup>1</sup> / <sub>16</sub> 1 <sup>1</sup> / <sub>8</sub> 1 <sup>1</sup> / <sub>16</sub>	<b>UCT306D1</b> <b>UCT306-101D1</b> <b>UCT306-102D1</b> <b>UCT306-103D1</b>	18	16	70	41	28	74	16	90	100	137	28	41	52	85	43	17
		2 <sup>3</sup> / <sub>32</sub>	5 <sup>5</sup> / <sub>8</sub>	2 <sup>3</sup> / <sub>4</sub>	1 <sup>5</sup> / <sub>8</sub>	1 <sup>3</sup> / <sub>32</sub>	2 <sup>29</sup> / <sub>32</sub>	0.630	3 <sup>35</sup> / <sub>64</sub>	3 <sup>15</sup> / <sub>16</sub>	5 <sup>13</sup> / <sub>32</sub>	1 <sup>3</sup> / <sub>32</sub>	1 <sup>5</sup> / <sub>8</sub>	2 <sup>1</sup> / <sub>16</sub>	3 <sup>11</sup> / <sub>32</sub>	1.6929	0.669
35 1 <sup>1</sup> / <sub>4</sub> 1 <sup>5</sup> / <sub>16</sub> 1 <sup>3</sup> / <sub>8</sub> 1 <sup>1</sup> / <sub>16</sub>	<b>UCT307D1</b> <b>UCT307-104D1</b> <b>UCT307-105D1</b> <b>UCT307-106D1</b> <b>UCT307-107D1</b>	20	17	75	45	30	80	16	100	111	150	32	45	56	94	48	19
		2 <sup>5</sup> / <sub>32</sub>	2 <sup>1</sup> / <sub>32</sub>	2 <sup>15</sup> / <sub>16</sub>	1 <sup>25</sup> / <sub>32</sub>	1 <sup>3</sup> / <sub>16</sub>	3 <sup>5</sup> / <sub>32</sub>	0.630	3 <sup>15</sup> / <sub>16</sub>	4 <sup>3</sup> / <sub>8</sub>	5 <sup>29</sup> / <sub>32</sub>	1 <sup>1</sup> / <sub>4</sub>	1 <sup>25</sup> / <sub>32</sub>	2 <sup>7</sup> / <sub>32</sub>	3 <sup>1</sup> / <sub>16</sub>	1.8898	0.748
40 1 <sup>1</sup> / <sub>2</sub> 1 <sup>7</sup> / <sub>16</sub>	<b>UCT308D1</b> <b>UCT308-108D1</b> <b>UCT308-109D1</b>	22	19	83	50	32	89	18	112	124	162	34	50	62	100	52	19
		7 <sup>7</sup> / <sub>8</sub>	3 <sup>3</sup> / <sub>4</sub>	3 <sup>9</sup> / <sub>32</sub>	1 <sup>31</sup> / <sub>32</sub>	1 <sup>1</sup> / <sub>4</sub>	3 <sup>1</sup> / <sub>2</sub>	0.709	4 <sup>13</sup> / <sub>32</sub>	4 <sup>7</sup> / <sub>8</sub>	6 <sup>3</sup> / <sub>8</sub>	1 <sup>11</sup> / <sub>32</sub>	1 <sup>31</sup> / <sub>32</sub>	2 <sup>7</sup> / <sub>16</sub>	3 <sup>15</sup> / <sub>16</sub>	2.0472	0.748
45 1 <sup>5</sup> / <sub>8</sub> 1 <sup>1</sup> / <sub>16</sub> 1 <sup>3</sup> / <sub>4</sub>	<b>UCT309D1</b> <b>UCT309-110D1</b> <b>UCT309-111D1</b> <b>UCT309-112D1</b>	24	20	90	55	34	97	18	125	138	178	38	55	68	110	57	22
		1 <sup>15</sup> / <sub>16</sub>	2 <sup>5</sup> / <sub>32</sub>	3 <sup>17</sup> / <sub>32</sub>	2 <sup>5</sup> / <sub>32</sub>	1 <sup>11</sup> / <sub>32</sub>	3 <sup>13</sup> / <sub>16</sub>	0.709	4 <sup>59</sup> / <sub>64</sub>	5 <sup>7</sup> / <sub>16</sub>	7	1 <sup>1</sup> / <sub>2</sub>	2 <sup>5</sup> / <sub>32</sub>	2 <sup>11</sup> / <sub>16</sub>	4 <sup>11</sup> / <sub>32</sub>	2.2441	0.866
50 1 <sup>3</sup> / <sub>16</sub> 1 <sup>1</sup> / <sub>6</sub> 1 <sup>15</sup> / <sub>16</sub>	<b>UCT310D1</b> <b>UCT310-113D1</b> <b>UCT310-114D1</b> <b>UCT310-115D1</b>	27	22	98	61	37	106	20	140	151	192	40	61	74	118	61	22
		1 <sup>1</sup> / <sub>16</sub>	7 <sup>7</sup> / <sub>8</sub>	3 <sup>27</sup> / <sub>32</sub>	2 <sup>13</sup> / <sub>32</sub>	1 <sup>15</sup> / <sub>32</sub>	4 <sup>3</sup> / <sub>16</sub>	0.787	5 <sup>33</sup> / <sub>64</sub>	5 <sup>15</sup> / <sub>16</sub>	7 <sup>7</sup> / <sub>16</sub>	1 <sup>9</sup> / <sub>16</sub>	2 <sup>13</sup> / <sub>32</sub>	2 <sup>29</sup> / <sub>32</sub>	4 <sup>21</sup> / <sub>32</sub>	2.4016	0.866

Note (1) These numbers indicate relubricatable type. If maintenance free type is needed, please order without suffix "D1".

Remarks Please refer to page A21 for size of grease fitting.

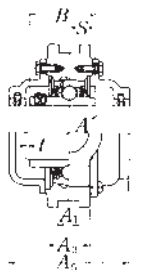
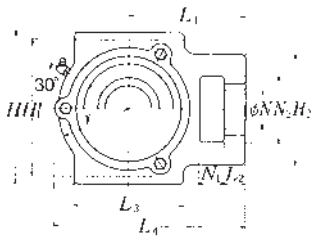

Cast dust cover type  
 Open end **C-UCT---D1**  
 Closed end **CM-UCT---D1**

Bearing number	Housing number	Unit number (1) cast dust cover type	Nominal dimensions			Mass of unit	
			mm		inch	kg lb	
			t max.	L <sub>4</sub>	A <sub>5</sub>	UCT	C(CM)
UC305D1	T305D1	<b>C(CM)-UCT305D1</b>	2	122	80	1.4	1.7
UC305-013D1	T305D1	<b>C(CM)-UCT305-013D1</b>					
UC305-014D1	T305D1	<b>C(CM)-UCT305-014D1</b>					
UC305-015D1	T305D1	<b>C(CM)-UCT305-015D1</b>	5/64	4 <sup>19</sup> / <sub>16</sub>	3 <sup>5</sup> / <sub>32</sub>	3.1	3.7
UC305-100D1	T305D1	<b>C(CM)-UCT305-100D1</b>					
UC306D1	T306D1	<b>C(CM)-UCT306D1</b>	2	139	85	1.8	2.4
UC306-101D1	T306D1	<b>C(CM)-UCT306-101D1</b>					
UC306-102D1	T306D1	<b>C(CM)-UCT306-102D1</b>	5/64	5 <sup>15</sup> / <sub>32</sub>	3 <sup>11</sup> / <sub>32</sub>	4.0	5.3
UC306-103D1	T306D1	<b>C(CM)-UCT306-103D1</b>					
UC307D1	T307D1	<b>C(CM)-UCT307D1</b>	3	152	95	2.3	3.2
UC307-104D1	T307D1	<b>C(CM)-UCT307-104D1</b>					
UC307-105D1	T307D1	<b>C(CM)-UCT307-105D1</b>					
UC307-106D1	T307D1	<b>C(CM)-UCT307-106D1</b>	1/8	5 <sup>31</sup> / <sub>32</sub>	3 <sup>3</sup> / <sub>4</sub>	5.1	7.1
UC307-107D1	T307D1	<b>C(CM)-UCT307-107D1</b>					
UC308D1	T308D1	<b>C(CM)-UCT308D1</b>	3	164	105	3.0	4.2
UC308-108D1	T308D1	<b>C(CM)-UCT308-108D1</b>					
UC308-109D1	T308D1	<b>C(CM)-UCT308-109D1</b>	1/8	6 <sup>15</sup> / <sub>32</sub>	4 <sup>1</sup> / <sub>8</sub>	6.6	9.3
UC309D1	T309D1	<b>C(CM)-UCT309D1</b>	3	181	110	4.0	5.4
UC309-110D1	T309D1	<b>C(CM)-UCT309-110D1</b>					
UC309-111D1	T309D1	<b>C(CM)-UCT309-111D1</b>	1/8	7 <sup>1</sup> / <sub>8</sub>	4 <sup>11</sup> / <sub>32</sub>	8.8	12
UC309-112D1	T309D1	<b>C(CM)-UCT309-112D1</b>					
UC310D1	T310D1	<b>C(CM)-UCT310D1</b>	3	197	120	5.0	7.0
UC310-113D1	T310D1	<b>C(CM)-UCT310-113D1</b>					
UC310-114D1	T310D1	<b>C(CM)-UCT310-114D1</b>	1/8	7 <sup>3</sup> / <sub>4</sub>	4 <sup>29</sup> / <sub>32</sub>	11	15
UC310-115D1	T310D1	<b>C(CM)-UCT310-115D1</b>					



## Take-up unit, cast housing Set screw type

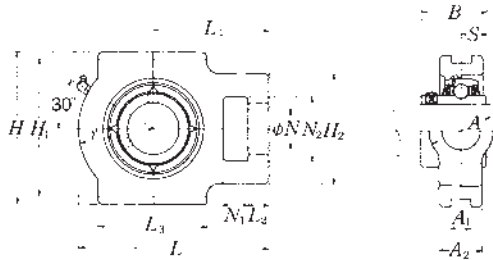

Shaft dia. mm inch	Unit number (1)	Nominal dimensions															
		mm inch															
		$N_1$	$L_2$	$H_2$	$N_2$	$N$	$L_3$	$A_1$	$H_1$	$H$	$L$	$A_2$	$A$	$r$	$L_1$	$B$	$S$
55 2 2 1/16 2 1/8 2 3/16	UCT311D1 UCT311-200D1 UCT311-202D1 UCT311-203D1	29	23	105	66	39	115	22	150	163	207	44	66	80	127	66	25
		1 5/32	29/32	4 1/8	2 19/32	1 17/32	4 17/32	0.866	5 29/32	6 13/32	8 5/32	1 23/32	2 19/32	3 5/32	5	2.5984	0.984
60 2 1/4 2 5/16 2 3/8 2 7/16	UCT312D1 UCT312-204D1 UCT312-205D1 UCT312-206D1 UCT312-207D1	31	25	113	71	41	123	22	160	178	220	46	71	85	135	71	26
		1 7/32	3 1/32	4 7/16	2 25/32	1 5/8	4 27/32	0.866	6 19/64	7	8 21/32	1 13/16	2 25/32	3 11/32	5 9/16	2.7953	1.024
65 2 1/2 2 5/16	UCT313D1 UCT313-208D1 UCT313-209D1	32	27	116	70	43	134	26	170	190	238	50	80	92	146	75	30
		1 1/4	1 1/16	4 9/16	2 3/4	1 11/16	5 9/32	1.024	6 11/16	7 15/32	9 3/8	1 31/32	3 5/32	3 5/8	5 3/4	2.9528	1.181
70 2 5/8 2 11/16 2 3/4	UCT314D1 UCT314-210D1 UCT314-211D1 UCT314-212D1	36	27	130	85	46	140	26	180	202	252	52	90	97	155	78	33
		1 19/32	1 1/16	5 1/8	3 11/32	1 13/16	5 1/2	1.024	7 9/32	7 15/16	9 29/32	2 1/16	3 17/32	3 13/16	6 3/32	3.0709	1.299
75 2 3/16 2 7/8 2 5/16 3	UCT315D1 UCT315-213D1 UCT315-214D1 UCT315-215D1 UCT315-300D1	36	27	132	85	46	150	26	192	216	262	55	90	102	160	82	32
		1 13/32	1 1/16	5 3/16	3 11/32	1 13/16	5 29/32	1.024	7 9/16	8 1/2	10 5/16	2 5/32	3 17/32	4 1/32	6 5/16	3.2283	1.260
80 3 1/16 3 1/8 3 3/16	UCT316D1 UCT316-301D1 UCT316-302D1 UCT316-303D1	42	30	150	98	53	160	30	204	230	282	60	102	108	174	86	34
		1 21/32	1 3/16	5 29/32	3 27/32	2 3/32	6 5/16	1.181	8 1/32	9 1/16	11 3/32	2 3/8	4 1/32	4 1/4	6 27/32	3.3858	1.339

Note (1) These numbers indicate relubricatable type. If maintenance free type is needed, please order without suffix "D1".

Remarks Please refer to page A21 for size of grease fitting.

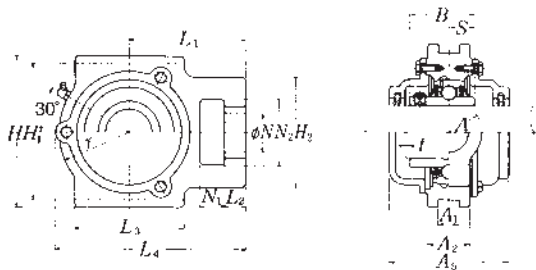

Cast dust cover type  
 Open end **C-UCT---D1**  
 Closed end **CM-UCT---D1**

Bearing number	Housing number	Unit number (*) cast dust cover type	Nominal dimensions			Mass of unit	
			<i>t</i> max.	<i>L</i> <sub>4</sub>	<i>A</i> <sub>3</sub>	kg	lb
UC311D1	T311D1	<b>C(CM)-UCT311D1</b>	4	211	125	6.3	8.4
UC311-200D1	T311D1	<b>C(CM)-UCT311-200D1</b>					
UC311-201D1	T311D1	<b>C(CM)-UCT311-201D1</b>					
UC311-202D1	T311D1	<b>C(CM)-UCT311-202D1</b>	5/32	8 5/16	4 29/32	14	19
UC311-203D1	T311D1	<b>C(CM)-UCT311-203D1</b>					
UC312D1	T312D1	<b>C(CM)-UCT312D1</b>	4	227	135	7.6	10
UC312-204D1	T312D1	<b>C(CM)-UCT312-204D1</b>					
UC312-205D1	T312D1	<b>C(CM)-UCT312-205D1</b>					
UC312-206D1	T312D1	<b>C(CM)-UCT312-206D1</b>	5/32	8 15/16	5 5/16	17	22
UC312-207D1	T312D1	<b>C(CM)-UCT312-207D1</b>					
UC313D1	T313D1	<b>C(CM)-UCT313D1</b>	4	244	140	9.4	12
UC313-208D1	T313D1	<b>C(CM)-UCT313-208D1</b>					
UC313-209D1	T313D1	<b>C(CM)-UCT313-209D1</b>	5/32	9 19/32	5 1/2	21	26
UC314D1	T314D1	<b>C(CM)-UCT314D1</b>	4	258	140	11	14
UC314-210D1	T314D1	<b>C(CM)-UCT314-210D1</b>					
UC314-211D1	T314D1	<b>C(CM)-UCT314-211D1</b>	5/32	10 5/32	5 1/2	24	31
UC314-212D1	T314D1	<b>C(CM)-UCT314-212D1</b>					
UC315D1	T315D1	<b>C(CM)-UCT315D1</b>	4	268	150	13	17
UC315-213D1	T315D1	<b>C(CM)-UCT315-213D1</b>					
UC315-214D1	T315D1	<b>C(CM)-UCT315-214D1</b>					
UC315-215D1	T315D1	<b>C(CM)-UCT315-215D1</b>	5/32	10 9/16	5 29/32	29	37
UC315-300D1	T315D1	<b>C(CM)-UCT315-300D1</b>					
UC316D1	T316D1	<b>C(CM)-UCT316D1</b>	4	287	155	16	20
UC316-301D1	T316D1	<b>C(CM)-UCT316-301D1</b>					
UC316-302D1	T316D1	<b>C(CM)-UCT316-302D1</b>					
UC316-303D1	T316D1	<b>C(CM)-UCT316-303D1</b>	5/32	11 5/16	6 3/32	35	44

# UCT3

## Take-up unit, cast housing Set screw type

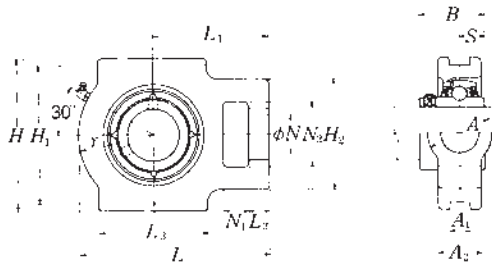

Shaft dia. mm inch	Unit number (1)	Nominal dimensions															
		mm inch															
		$N_1$	$L_2$	$H_2$	$N_2$	$N$	$L_3$	$A_1$	$H_1$	$H$	$L$	$A_2$	$A$	$r$	$L_1$	$B$	$S$
85 3 3/4 3 5/16 3 7/16	UCT317D1 UCT317-304D1 UCT317-305D1 UCT317-307D1	42	32	152	98	53	170	32	214	240	298	64	102	115	183	96	40
		1 <sup>21</sup> / <sub>32</sub>	1 1/4	5 <sup>31</sup> / <sub>32</sub>	3 <sup>27</sup> / <sub>32</sub>	2 <sup>3</sup> / <sub>32</sub>	6 <sup>1</sup> / <sub>16</sub>	1.260	8 <sup>27</sup> / <sub>64</sub>	9 <sup>7</sup> / <sub>16</sub>	11 <sup>23</sup> / <sub>32</sub>	2 <sup>17</sup> / <sub>32</sub>	4 <sup>1</sup> / <sub>32</sub>	4 <sup>17</sup> / <sub>32</sub>	7 <sup>7</sup> / <sub>32</sub>	3.7795	1.575
90 3 7/16 3 1/2	UCT318D1 UCT318-307D1 UCT318-308D1	46	32	160	106	57	175	32	228	255	312	66	110	120	192	96	40
		1 <sup>13</sup> / <sub>16</sub>	1 1/4	6 <sup>5</sup> / <sub>16</sub>	4 <sup>3</sup> / <sub>16</sub>	2 1/4	6 7/8	1.260	8 <sup>3</sup> / <sub>32</sub>	10 <sup>1</sup> / <sub>32</sub>	12 <sup>9</sup> / <sub>32</sub>	2 <sup>19</sup> / <sub>32</sub>	4 <sup>11</sup> / <sub>32</sub>	4 <sup>29</sup> / <sub>32</sub>	7 <sup>9</sup> / <sub>16</sub>	3.7795	1.575
95 3 5/8 3 11/16 3 3/4	UCT319D1 UCT319-310D1 UCT319-311D1 UCT319-312D1	46	33	165	106	57	180	35	240	270	322	72	110	125	197	103	41
		1 <sup>13</sup> / <sub>16</sub>	1 5/16	6 1/2	4 <sup>3</sup> / <sub>16</sub>	2 1/4	7 <sup>3</sup> / <sub>32</sub>	1.378	9 <sup>29</sup> / <sub>64</sub>	10 <sup>5</sup> / <sub>8</sub>	12 <sup>11</sup> / <sub>16</sub>	2 <sup>27</sup> / <sub>32</sub>	4 <sup>11</sup> / <sub>32</sub>	4 <sup>29</sup> / <sub>32</sub>	7 <sup>3</sup> / <sub>4</sub>	4.0551	1.614
100 3 3/8 3 7/8 3 15/16 4	UCT320D1 UCT320-313D1 UCT320-314D1 UCT320-315D1 UCT320-400D1	48	34	175	115	59	200	35	260	290	345	75	120	135	210	108	42
		1 7/8	1 11/32	6 7/8	4 <sup>17</sup> / <sub>32</sub>	2 <sup>5</sup> / <sub>16</sub>	7 7/8	1.378	10 <sup>15</sup> / <sub>64</sub>	11 <sup>13</sup> / <sub>32</sub>	13 <sup>19</sup> / <sub>32</sub>	2 <sup>15</sup> / <sub>16</sub>	4 <sup>23</sup> / <sub>32</sub>	5 <sup>5</sup> / <sub>16</sub>	8 <sup>9</sup> / <sub>32</sub>	4.2520	1.654
105	UCT321D1	48	34	175	115	59	200	35	260	290	347	75	120	135	212	112	44
110	UCT322D1	52	40	185	125	65	215	38	285	320	385	80	130	150	235	117	46
120	UCT324D1	60	44	210	140	70	230	45	320	355	432	90	140	165	267	126	51
130	UCT326D1	65	47	220	150	75	240	50	350	385	465	100	150	180	285	135	54
140	UCT328D1	70	52	230	160	80	255	50	380	415	515	100	155	200	315	145	59

Note (1) These numbers indicate relubricatable type. If maintenance free type is needed, please order without suffix "D1".

Remarks Please refer to page A21 for size of grease fitting.

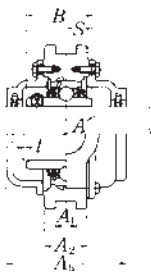
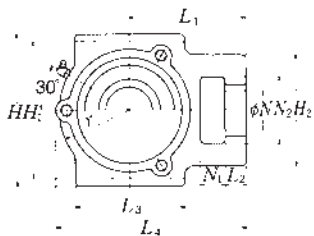

Cast dust cover type  
 Open end **C-UCT---D1**  
 Closed end **CM-UCT---D1**

Bearing number	Housing number	Unit number (1) cast dust cover type	Nominal dimensions			Mass of unit	
			<i>t</i> max.	<i>L</i> <sub>4</sub>	<i>A</i> <sub>5</sub>	UCT	C(CM)
UC317D1	T317D1	<b>C(CM)-UCT317D1</b>	5	303	170	19	25
UC317-304D1	T317D1	<b>C(CM)-UCT317-304D1</b>					
UC317-305D1	T317D1	<b>C(CM)-UCT317-305D1</b>	<sup>13</sup> / <sub>64</sub>	11 <sup>15</sup> / <sub>16</sub>	6 <sup>11</sup> / <sub>16</sub>	42	55
UC317-307D1	T317D1	<b>C(CM)-UCT317-307D1</b>					
UC318D1	T318D1	<b>C(CM)-UCT318D1</b>	5	317	170	21	27
UC318-307D1	T318D1	<b>C(CM)-UCT318-307D1</b>					
UC318-308D1	T318D1	<b>C(CM)-UCT318-308D1</b>	<sup>13</sup> / <sub>64</sub>	12 <sup>15</sup> / <sub>32</sub>	6 <sup>11</sup> / <sub>16</sub>	46	60
UC319D1	T319D1	<b>C(CM)-UCT319D1</b>	5	327	180	24	31
UC319-310D1	T319D1	<b>C(CM)-UCT319-310D1</b>					
UC319-311D1	T319D1	<b>C(CM)-UCT319-311D1</b>	<sup>13</sup> / <sub>64</sub>	12 <sup>7</sup> / <sub>8</sub>	7 <sup>3</sup> / <sub>32</sub>	53	68
UC319-312D1	T319D1	<b>C(CM)-UCT319-312D1</b>					
UC320D1	T320D1	<b>C(CM)-UCT320D1</b>	5	350	190	30	38
UC320-313D1	T320D1	<b>C(CM)-UCT320-313D1</b>					
UC320-314D1	T320D1	<b>C(CM)-UCT320-314D1</b>					
UC320-315D1	T320D1	<b>C(CM)-UCT320-315D1</b>	<sup>13</sup> / <sub>64</sub>	13 <sup>25</sup> / <sub>32</sub>	7 <sup>15</sup> / <sub>32</sub>	66	84
UC320-400D1	T320D1	<b>C(CM)-UCT320-400D1</b>					
UC321D1	T321D1	<b>C(CM)-UCT321D1</b>	5	359	195	32	43
UC322D1	T322D1	<b>C(CM)-UCT322D1</b>	5	395	200	40	55
UC324D1	T324D1	<b>C(CM)-UCT324D1</b>	5	439	215	55	71
UC326D1	T326D1	<b>C(CM)-UCT326D1</b>	6	476	225	69	92
UC328D1	T328D1	<b>C(CM)-UCT328D1</b>	6	519	235	84	111

## Take-up unit, cast housing Set screw type

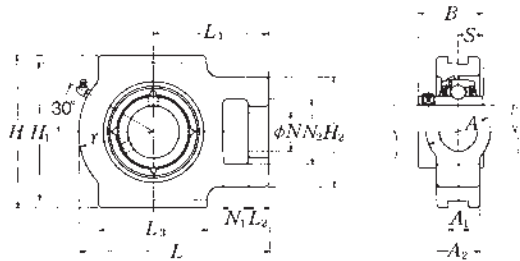

Shaft dia. mm inch	Unit number (*)	Nominal dimensions															
		mm inch															
		$N_1$	$L_2$	$H_2$	$N_2$	$N$	$L_3$	$A_1$	$H_1$	$H$	$L$	$A_2$	$A$	$r$	$L_1$	$B$	$S$
25 13/16 7/8 15/16 1	<b>UCTX05D1</b> <b>UCTX05-013D1</b> <b>UCTX05-014D1</b> <b>UCTX05-015D1</b> <b>UCTX05-100D1</b>	16	12	56	37	22	57	12	89	102	113	28	37	43	70	38.1	15.9
		5/8	15/32	27/32	15/32	7/8	2 1/4	0.472	3 1/2	4 3/32	4 7/16	1 3/32	1 15/32	1 1/16	2 3/4	1.5000	0.626
30 1 1/16 1 1/8 1 3/8 1 1/4	<b>UCTX06D1</b> <b>UCTX06-101D1</b> <b>UCTX06-102D1</b> <b>UCTX06-103D1</b> <b>UCTX06-104D1</b>	16	15	64	37	22	64	12	89	102	129	30	37	51	78	42.9	17.5
		5/8	19/32	2 17/32	1 15/32	7/8	2 17/32	0.472	3 1/2	4 1/32	5 3/32	1 3/16	1 15/32	2	3 1/16	1.6890	0.689
35 1 5/16 1 3/8 1 7/16	<b>UCTX07D1</b> <b>UCTX07-105D1</b> <b>UCTX07-106D1</b> <b>UCTX07-107D1</b>	19	17	83	49	29	83	16	102	114	144	36	49	56	88	49.2	19
		3/4	2 1/32	3 9/32	1 15/16	1 5/32	3 3/32	0.630	4 1/64	4 1/2	5 21/32	1 13/32	1 15/16	2 7/32	3 5/32	1.9370	0.748
40 1 1/2 1 7/16	<b>UCTX08D1</b> <b>UCTX08-108D1</b> <b>UCTX08-109D1</b>	19	17	83	49	29	83	16	102	117	144	36	49	57	87	49.2	19
		3/4	2 1/32	3 9/32	1 15/16	1 5/32	3 3/32	0.630	4 1/64	4 19/32	5 21/32	1 13/32	1 15/16	2 1/4	3 7/16	1.9370	0.748
45 1 5/8 1 11/16 1 3/4 1 13/16	<b>UCTX09D1</b> <b>UCTX09-110D1</b> <b>UCTX09-111D1</b> <b>UCTX09-112D1</b> <b>UCTX09-113D1</b>	19	18	83	49	29	86	16	102	117	151	38	49	59	92	51.6	19
		3/4	23/32	3 9/32	1 15/16	1 5/32	3 3/8	0.630	4 1/64	4 19/32	5 15/16	1 1/2	1 15/16	2 5/16	3 5/8	2.0315	0.748
50 1 7/8 1 15/16 2	<b>UCTX10D1</b> <b>UCTX10-114D1</b> <b>UCTX10-115D1</b> <b>UCTX10-200D1</b>	25	21	102	64	35	95	22	130	146	171	42	64	65	106	55.6	22.2
		3 1/32	1 3/16	4 1/32	2 17/32	1 3/8	3 3/4	0.866	5 1/8	5 3/4	6 23/32	1 21/32	2 17/32	2 9/16	4 3/16	2.1890	0.874

Note (\*) These numbers indicate relubricatable type. If maintenance free type is needed, please order without suffix "D1".

Remarks Please refer to page A21 for size of grease fitting.

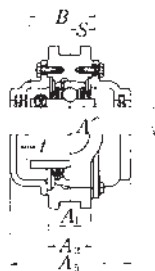
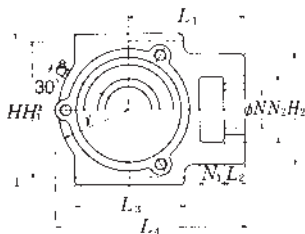

Cast dust cover type  
 Open end **C-UCT...D1**  
 Closed end **CM-UCT...D1**

Bearing number	Housing number	Unit number (1) cast dust cover type	Nominal dimensions			Mass of unit	
			<i>t</i> max.	<i>L</i> <sub>4</sub>	<i>A</i> <sub>5</sub>	kg	lb
UCX05D1	TX05D1	<b>C(CM)-UCTX05D1</b>	2	113.5	75	1.4	1.8
UCX05-013D1	TX05D1	<b>C(CM)-UCTX05-013D1</b>	$\frac{5}{64}$	$4\frac{15}{32}$	$2\frac{15}{16}$	3.1	4.0
UCX05-014D1	TX05D1	<b>C(CM)-UCTX05-014D1</b>					
UCX05-015D1	TX05D1	<b>C(CM)-UCTX05-015D1</b>					
UCX05-100D1	TX05D1	<b>C(CM)-UCTX05-100D1</b>					
UCX06D1	TX06D1	<b>C(CM)-UCTX06D1</b>	2	129	80	1.8	2.3
UCX06-101D1	TX06D1	<b>C(CM)-UCTX06-101D1</b>	$\frac{5}{64}$	$5\frac{3}{32}$	$3\frac{5}{32}$	4.0	5.1
UCX06-102D1	TX06D1	<b>C(CM)-UCTX06-102D1</b>					
UCX06-103D1	TX06D1	<b>C(CM)-UCTX06-103D1</b>					
UC207-104D1	TX06D1	<b>C(CM)-UCTX06-104D1</b>					
UCX07D1	TX07D1	<b>C(CM)-UCTX07D1</b>	3	144	90	2.6	3.5
UCX07-105D1	TX07D1	<b>C(CM)-UCTX07-105D1</b>	$\frac{1}{8}$	$5\frac{29}{32}$	$3\frac{17}{32}$	5.7	7.7
UCX07-106D1	TX07D1	<b>C(CM)-UCTX07-106D1</b>					
UCX07-107D1	TX07D1	<b>C(CM)-UCTX07-107D1</b>					
UCX08D1	TX08D1	<b>C(CM)-UCTX08D1</b>	3	144.5	95	2.6	3.5
UCX08-108D1	TX08D1	<b>C(CM)-UCTX08-108D1</b>	$\frac{1}{8}$	$5\frac{1}{16}$	$3\frac{3}{4}$	5.7	7.7
UCX08-109D1	TX08D1	<b>C(CM)-UCTX08-109D1</b>					
UCX09D1	TX09D1	<b>C(CM)-UCTX09D1</b>	3	152	100	2.7	3.7
UCX09-110D1	TX09D1	<b>C(CM)-UCTX09-110D1</b>	$\frac{1}{8}$	$5\frac{39}{32}$	$3\frac{15}{16}$	6.0	8.2
UCX09-111D1	TX09D1	<b>C(CM)-UCTX09-111D1</b>					
UCX09-112D1	TX09D1	<b>C(CM)-UCTX09-112D1</b>					
UC210-113D1	TX09D1	<b>C(CM)-UCTX09-113D1</b>					
UCX10D1	TX10D1	<b>C(CM)-UCTX10D1</b>	3	171.5	100	4.2	5.4
UCX10-114D1	TX10D1	<b>C(CM)-UCTX10-114D1</b>	$\frac{1}{8}$	$6\frac{3}{4}$	$3\frac{15}{16}$	9.3	12
UCX10-115D1	TX10D1	<b>C(CM)-UCTX10-115D1</b>					
UC211-200D1	TX10D1	<b>C(CM)-UCTX10-200D1</b>					

## Take-up unit, cast housing Set screw type

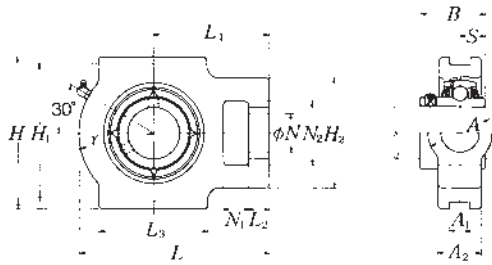

Shaft dia. mm inch	Unit number (1)	Nominal dimensions															
		mm inch															
		$N_1$	$L_2$	$H_2$	$N_2$	$N$	$L_3$	$A_1$	$H_1$	$H$	$L$	$A_2$	$A$	$r$	$L_1$	$B$	$S$
55 2 1/16 2 1/8 2 3/16 2 1/4 2 5/16	<b>UCTX11D1</b> <b>UCTX11-201D1</b> <b>UCTX11-202D1</b> <b>UCTX11-203D1</b> <b>UCTX11-204D1</b> <b>UCTX11-205D1</b>	32	21	102	64	35	102	22	130	146	194	44	64	75	119	65.1	25.4
60 2 3/8 2 7/16	<b>UCTX12D1</b> <b>UCTX12-206D1</b> <b>UCTX12-207D1</b>	32	23	111	70	41	121	26	151	167	224	48	70	87	137	65.1	25.4
65 2 1/2 2 9/16	<b>UCTX13D1</b> <b>UCTX13-208D1</b> <b>UCTX13-209D1</b>	32	23	111	70	41	121	26	151	167	224	48	70	87	137	74.6	30.2
70 2 5/8 2 11/16 2 3/4	<b>UCTX14D1</b> <b>UCTX14-210D1</b> <b>UCTX14-211D1</b> <b>UCTX14-212D1</b>	32	23	111	70	41	121	26	151	167	232	48	70	92	140	77.8	33.3
75 2 9/16 2 7/8 2 15/16 3	<b>UCTX15D1</b> <b>UCTX15-213D1</b> <b>UCTX15-214D1</b> <b>UCTX15-215D1</b> <b>UCTX15-300D1</b>	32	23	111	70	41	121	28	165	184	235	48	70	95	140	82.6	33.3
80 3 1/16 3 1/8 3 3/16 3 1/4	<b>UCTX16D1</b> <b>UCTX16-301D1</b> <b>UCTX16-302D1</b> <b>UCTX16-303D1</b> <b>UCTX16-304D1</b>	38	30	124	73	48	157	28	173	198	260	54	73	98	162	85.7	34.1
85 3 5/16 3 7/16	<b>UCTX17D1</b> <b>UCTX17-305D1</b> <b>UCTX17-307D1</b>	38	30	124	73	48	157	28	173	198	260	54	73	98	162	96	39.7

Note (1) These numbers indicate relubricatable type. If maintenance free type is needed, please order without suffix "D1".

Remarks Please refer to page A21 for size of grease fitting.

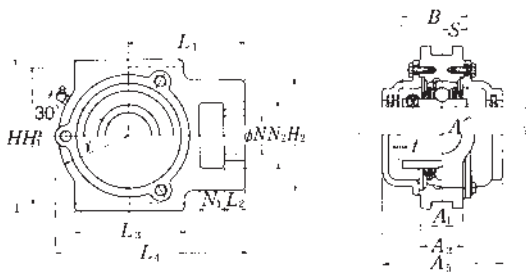

Cast dust cover type  
 Open end **C-UCT...D1**  
 Closed end **CM-UCT...D1**

Bearing number	Housing number	Unit number (1) cast dust cover type	Nominal dimensions			Mass of unit	
			<i>t</i> max.	<i>L</i> <sub>4</sub>	<i>A</i> <sub>5</sub>	kg	lb
						UCT	C(CM)
UCX11D1	TX11D1	<b>C(CM)-UCTX11D1</b>	4	194	115	5.2	6.7
UCX11-201D1	TX11D1	<b>C(CM)-UCTX11-201D1</b>					
UCX11-202D1	TX11D1	<b>C(CM)-UCTX11-202D1</b>					
UCX11-203D1	TX11D1	<b>C(CM)-UCTX11-203D1</b>	5/32	7 5/8	4 17/32	11	15
UC212-204D1	TX11D1	<b>C(CM)-UCTX11-204D1</b>					
UC212-205D1	TX11D1	<b>C(CM)-UCTX11-205D1</b>					
UCX12D1	TX12D1	<b>C(CM)-UCTX12D1</b>	4	224	120	7.2	9.0
UCX12-206D1	TX12D1	<b>C(CM)-UCTX12-206D1</b>	5/32	8 13/16	4 23/32	16	20
UCX12-207D1	TX12D1	<b>C(CM)-UCTX12-207D1</b>					
UCX13D1	TX13D1	<b>C(CM)-UCTX13D1</b>	4	224	135	7.5	9.8
UCX13-208D1	TX13D1	<b>C(CM)-UCTX13-208D1</b>	5/32	8 13/16	5 5/16	17	22
UCX13-209D1	TX13D1	<b>C(CM)-UCTX13-209D1</b>					
UCX14D1	TX14D1	<b>C(CM)-UCTX14D1</b>	4	232	135	7.7	10
UCX14-210D1	TX14D1	<b>C(CM)-UCTX14-210D1</b>					
UCX14-211D1	TX14D1	<b>C(CM)-UCTX14-211D1</b>	5/32	9 1/8	5 5/16	17	22
UCX14-212D1	TX14D1	<b>C(CM)-UCTX14-212D1</b>					
UCX15D1	TX15D1	<b>C(CM)-UCTX15D1</b>	4	235	145	8.3	11
UCX15-213D1	TX15D1	<b>C(CM)-UCTX15-213D1</b>					
UCX15-214D1	TX15D1	<b>C(CM)-UCTX15-214D1</b>					
UCX15-215D1	TX15D1	<b>C(CM)-UCTX15-215D1</b>	5/32	9 1/4	5 23/32	18	24
UCX15-300D1	TX15D1	<b>C(CM)-UCTX15-300D1</b>					
UCX16D1	TX16D1	<b>C(CM)-UCTX16D1</b>	4	260	155	11	14
UCX16-301D1	TX16D1	<b>C(CM)-UCTX16-301D1</b>					
UCX16-302D1	TX16D1	<b>C(CM)-UCTX16-302D1</b>	5/32	10 1/4	6 3/32	24	31
UCX16-303D1	TX16D1	<b>C(CM)-UCTX16-303D1</b>					
UC217-304D1	TX16D1	<b>C(CM)-UCTX16-304D1</b>					
UCX17D1	TX17D1	<b>C(CM)-UCTX17D1</b>	5	262	165	11	15
UCX17-305D1	TX17D1	<b>C(CM)-UCTX17-305D1</b>	13/64	10 5/16	6 1/2	24	33
UCX17-307D1	TX17D1	<b>C(CM)-UCTX17-307D1</b>					



## Take-up stretcher units™ Set screw type

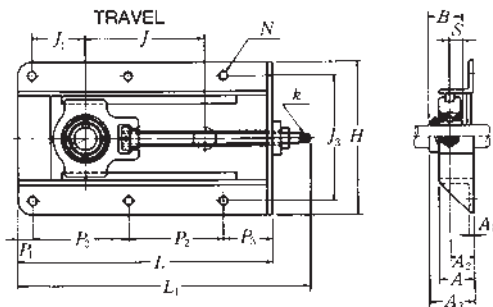

Shaft dia. mm	Unit number <sup>(1)</sup>	Nominal dimensions																
		mm																
		L	H	J	J <sub>1</sub>	J <sub>3</sub>	A <sub>1</sub>	A <sub>2</sub>	A	P <sub>1</sub>	P <sub>2</sub>	P <sub>3</sub>	N	L <sub>1</sub>	A <sub>3</sub>	B	S	k square
12	UCT201-15	317	199	150	69	154	6	30	50	19	117	64	12	370	48.3	31	12.7	9
15	UCT202-15	317	199	150	69	154	6	30	50	19	117	64	12	370	48.3	31	12.7	9
17	UCT203-15	317	199	150	69	154	6	30	50	19	117	64	12	370	48.3	31	12.7	9
20	UCT204-15	317	199	150	69	154	6	30	50	19	117	64	12	370	48.3	31	12.7	9
25	UCT205-15	317	199	150	68	154	6	30	50	19	117	64	12	370	49.8	34.1	14.3	9
30	UCT206-15	337	212	150	73	166	6	32	50	19	127	64	12	393	54.2	38.1	15.9	10
35	UCT207-23	429	212	230	80	166	6	32	50	19	173	64	12	485	57.4	42.9	17.5	10
40	UCT208-30	520	233	300	88	192	6	32	50	22	217	64	12	596	62.2	49.2	19	15
45	UCT209-30	520	233	300	88	192	6	32	50	22	217	64	12	596	62.2	49.2	19	15
50	UCT210-30	524	233	300	92	192	6	35	50	22	219	64	15	599	67.6	51.6	19	15
55	UCT211-30	542	285	300	93	240	8	38	65	22	230	60	15	630	71.4	55.6	22.2	17
60	UCT212-30	568	285	300	103	240	8	38	65	22	243	60	15	657	77.7	65.1	25.4	17
65	UCT213-30	606	306	300	125	260	8	43	65	22	260	64	15	705	82.7	65.1	25.4	23

Notes <sup>(1)</sup> If relubricatable type is needed, please order with suffix "D1".

<sup>(2)</sup> The Stretcher Units is designed to only take a horizontal radial load, in line with the adjustment direction. Axial loads or vertical radial loads can deform or break the housing.

Adjustment screw size	Bolt size	Max. load (°)	Bearing number	Mass of unit
		N		kg
TM16 × 3	M10	7 650	UC201D1	5.0
TM16 × 3	M10	7 650	UC202D1	5.0
TM16 × 3	M10	7 650	UC203D1	5.0
TM16 × 3	M10	7 650	UC204D1	5.0
TM16 × 3	M10	7 850	UC205D1	5.0
TM18 × 4	M10	9 810	UC206D1	5.7
TM18 × 4	M10	12 750	UC207D1	6.8
TM25 × 5	M10	15 690	UC208D1	11
TM25 × 5	M10	15 690	UC209D1	11
TM25 × 5	M12	16 670	UC210D1	11
TM30 × 6	M12	19 610	UC211D1	18
TM30 × 6	M12	21 570	UC212D1	20
TM30 × 6	M12	23 530	UC213D1	23

## Take-up type L stretcher units™ Set screw type

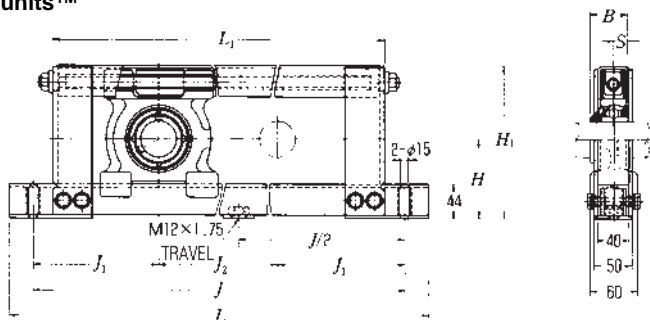

Shaft dia. mm	Unit number <sup>(1)</sup>	Nominal dimensions mm									Bolt size	Max. load <sup>(2)</sup> recommended N
		H	L	J	J <sub>2</sub>	L <sub>1</sub>	J <sub>1</sub>	H <sub>1</sub>	B	S		
20	UCL204-10	77	430	370	100	320	135	146	31	12.7	M12	1 960
	UCL204-20	77	530	470	200	420	135	146	31	12.7	M12	1 960
	UCL204-30	77	630	570	300	520	135	146	31	12.7	M12	1 960
	UCL204-40	77	730	670	400	620	135	146	31	12.7	M12	1 960
25	UCL205-10	82	440	380	100	330	140	156	34.1	14.3	M12	2 250
	UCL205-20	82	540	480	200	430	140	156	34.1	14.3	M12	2 250
	UCL205-30	82	640	580	300	530	140	156	34.1	14.3	M12	2 250
	UCL205-40	82	740	680	400	630	140	156	34.1	14.3	M12	2 250
30	UCL206-10	87	450	390	100	340	145	166	38.1	15.9	M12	3 230
	UCL206-20	87	550	490	200	440	145	166	38.1	15.9	M12	3 230
	UCL206-30	87	650	590	300	540	145	166	38.1	15.9	M12	3 230
	UCL206-40	87	750	690	400	640	145	166	38.1	15.9	M12	3 230
35	UCL207-10	92	460	400	100	350	150	176	42.9	17.5	M12	4 210
	UCL207-20	92	560	500	200	450	150	176	42.9	17.5	M12	4 210
	UCL207-30	92	660	600	300	550	150	176	42.9	17.5	M12	4 210
	UCL207-40	92	760	700	400	650	150	176	42.9	17.5	M12	4 210
40	UCL208-10	97	470	410	100	360	155	186	49.2	19	M12	4 500
	UCL208-20	97	570	510	200	460	155	186	49.2	19	M12	4 500
	UCL208-30	97	670	610	300	560	155	186	49.2	19	M12	4 500
	UCL208-40	97	770	710	400	660	155	186	49.2	19	M12	4 500
45	UCL209-10	100	480	420	100	370	160	192	49.2	19	M12	4 500
	UCL209-20	100	580	520	200	470	160	192	49.2	19	M12	4 500
	UCL209-30	100	680	620	300	570	160	192	49.2	19	M12	4 500
	UCL209-40	100	780	720	400	670	160	192	49.2	19	M12	4 500

Notes <sup>(1)</sup> If relubricatable type is needed, please order with suffix "D1".

<sup>(2)</sup> The Stretcher Units is designed to only take a horizontal radial load, in line with the adjustment direction. Axial loads or vertical radial loads can deform or break the housing.

Bearing number	Mass of unit
	kg
UC204D1	6.3
UC204D1	7.0
UC204D1	7.7
UC204D1	8.4
UC205D1	6.8
UC205D1	7.5
UC205D1	8.2
UC205D1	8.9
UC206D1	7.3
UC206D1	8.0
UC206D1	8.7
UC206D1	9.4
UC207D1	7.8
UC207D1	8.5
UC207D1	9.2
UC207D1	9.9
UC208D1	8.3
UC208D1	9.0
UC208D1	9.7
UC208D1	10
UC209D1	8.7
UC209D1	9.4
UC209D1	10
UC209D1	11

## Take-up type M stretcher units™ Set screw type

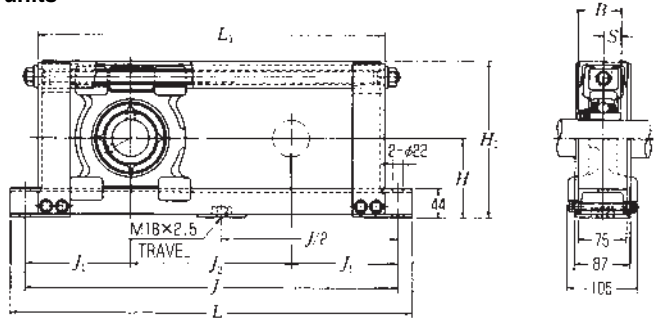

Shaft dia. mm	Unit number <sup>(1)</sup>	Nominal dimensions									Bolt size	Max. load <sup>(2)</sup> recommended N
		H	L	J	J <sub>2</sub>	mm L <sub>1</sub>	J <sub>1</sub>	H <sub>1</sub>	B	S		
40	UCM208-50	97	870	810	500	760	155	190	49.2	19	M18	5 190
	UCM208-60	97	970	910	600	860	155	190	49.2	19	M18	5 190
	UCM208-70	97	1070	1010	700	960	155	190	49.2	19	M18	5 190
	UCM208-80	97	1170	1110	800	1060	155	190	49.2	19	M18	5 190
	UCM208-90	97	1270	1210	900	1160	155	190	49.2	19	M18	5 190
45	UCM209-50	102	880	820	500	770	160	200	49.2	19	M18	5 880
	UCM209-60	102	980	920	600	870	160	200	49.2	19	M18	5 880
	UCM209-70	102	1080	1020	700	970	160	200	49.2	19	M18	5 880
	UCM209-80	102	1180	1120	800	1070	160	200	49.2	19	M18	5 880
	UCM209-90	102	1280	1220	900	1170	160	200	49.2	19	M18	5 880
50	UCM210-50	107	890	830	500	780	165	210	51.6	19	M18	6 460
	UCM210-60	107	990	930	600	880	165	210	51.6	19	M18	6 460
	UCM210-70	107	1090	1030	700	980	165	210	51.6	19	M18	6 460
	UCM210-80	107	1190	1130	800	1080	165	210	51.6	19	M18	6 460
	UCM210-90	107	1290	1230	900	1180	165	210	51.6	19	M18	6 460
55	UCM211-50	115	910	850	500	800	175	230	55.6	22.2	M18	6 460
	UCM211-60	115	1010	950	600	900	175	230	55.6	22.2	M18	6 460
	UCM211-70	115	1110	1050	700	1000	175	230	55.6	22.2	M18	6 460
	UCM211-80	115	1210	1150	800	1100	175	230	55.6	22.2	M18	6 460
	UCM211-90	115	1310	1250	900	1200	175	230	55.6	22.2	M18	6 460
60	UCM212-50	120	920	860	500	810	180	240	65.1	25.4	M18	6 460
	UCM212-60	120	1020	960	600	910	180	240	65.1	25.4	M18	6 460
	UCM212-70	120	1120	1060	700	1010	180	240	65.1	25.4	M18	6 460
	UCM212-80	120	1220	1160	800	1110	180	240	65.1	25.4	M18	6 460
	UCM212-90	120	1320	1260	900	1210	180	240	65.1	25.4	M18	6 460
65	UCM213-50	125	940	880	500	830	190	250	65.1	25.4	M18	6 460
	UCM213-60	125	1040	980	600	930	190	250	65.1	25.4	M18	6 460
	UCM213-70	125	1140	1080	700	1030	190	250	65.1	25.4	M18	6 460
	UCM213-80	125	1240	1180	800	1130	190	250	65.1	25.4	M18	6 460
	UCM213-90	125	1340	1280	900	1230	190	250	65.1	25.4	M18	6 460

Notes <sup>(1)</sup> If relubricatable type is needed, please order with suffix "D1".

<sup>(2)</sup> The Stretcher Units is designed to only take a horizontal radial load, in line with the adjustment direction. Axial loads or vertical radial loads can deform or break the housing.

Bearing number	Mass of unit
	kg
UC208D1	20
UC208D1	22
UC208D1	23
UC208D1	24
UC208D1	30
UC209D1	21
UC209D1	23
UC209D1	24
UC209D1	30
UC209D1	32
UC210D1	23
UC210D1	24
UC210D1	30
UC210D1	32
UC210D1	33
UC211D1	25
UC211D1	27
UC211D1	32
UC211D1	34
UC211D1	36
UC212D1	28
UC212D1	29
UC212D1	35
UC212D1	36
UC212D1	38
UC213D1	30
UC213D1	31
UC213D1	36
UC213D1	38
UC213D1	40

## Take-up type M stretcher units™ Set screw type

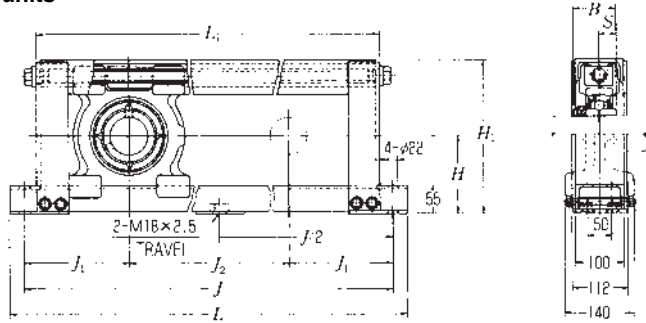

Shaft dia. mm	Unit number (1)	Nominal dimensions mm									Bolt size	Max. load (2) recommended N	Bearing number	Mass of unit kg
		H	L	J	J <sub>2</sub>	L <sub>1</sub>	J <sub>1</sub>	H <sub>1</sub>	B	S				
65	UCM313-50	145	940	880	500	830	190	285	75	30	M18	16 260	UC313D1	47
	UCM313-60	145	1040	980	600	930	190	285	75	30	M18	16 260	UC313D1	50
	UCM313-70	145	1140	1080	700	1030	190	285	75	30	M18	16 260	UC313D1	53
	UCM313-80	145	1240	1180	800	1130	190	285	75	30	M18	16 260	UC313D1	55
	UCM313-90	145	1340	1280	900	1230	190	285	75	30	M18	16 260	UC313D1	58
70	UCM314-50	150	960	900	500	850	200	295	78	33	M18	19 600	UC314D1	49
	UCM314-60	150	1060	1000	600	950	200	295	78	33	M18	19 600	UC314D1	52
	UCM314-70	150	1160	1100	700	1050	200	295	78	33	M18	19 600	UC314D1	55
	UCM314-80	150	1260	1200	800	1150	200	295	78	33	M18	19 600	UC314D1	58
	UCM314-90	150	1360	1300	900	1250	200	295	78	33	M18	19 600	UC314D1	61
75	UCM315-50	155	980	920	500	870	210	305	82	32	M18	19 600	UC315D1	52
	UCM315-60	155	1080	1020	600	970	210	305	82	32	M18	19 600	UC315D1	55
	UCM315-70	155	1180	1120	700	1070	210	305	82	32	M18	19 600	UC315D1	58
	UCM315-80	155	1280	1220	800	1170	210	305	82	32	M18	19 600	UC315D1	60
	UCM315-90	155	1380	1320	900	1270	210	305	82	32	M18	19 600	UC315D1	63
80	UCM316-50	160	1000	940	500	890	220	315	86	34	M18	19 600	UC316D1	54
	UCM316-60	160	1100	1040	600	990	220	315	86	34	M18	19 600	UC316D1	57
	UCM316-70	160	1200	1140	700	1090	220	315	86	34	M18	19 600	UC316D1	60
	UCM316-80	160	1300	1240	800	1190	220	315	86	34	M18	19 600	UC316D1	63
	UCM316-90	160	1400	1340	900	1290	220	315	86	34	M18	19 600	UC316D1	66
85	UCM317-50	165	1020	960	500	910	230	325	96	40	M18	19 600	UC317D1	60
	UCM317-60	165	1120	1060	600	1010	230	325	96	40	M18	19 600	UC317D1	63
	UCM317-70	165	1220	1160	700	1110	230	325	96	40	M18	19 600	UC317D1	65
	UCM317-80	165	1320	1260	800	1210	230	325	96	40	M18	19 600	UC317D1	68
	UCM317-90	165	1420	1360	900	1310	230	325	96	40	M18	19 600	UC317D1	71

Notes (1) If relubricatable type is needed, please order with suffix "D1".

(2) The Stretcher Units is designed to only take a horizontal radial load, in line with the adjustment direction. Axial loads or vertical radial loads can deform or break the housing.

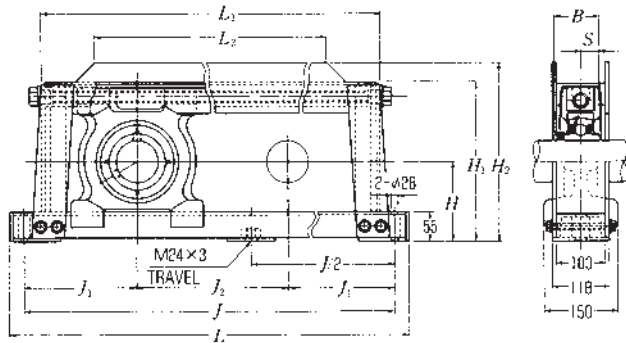

Shaft dia. mm	Unit number <sup>(1)</sup>	Nominal dimensions										Bolt size	Max. load <sup>(2)</sup> recommended N	Bearing number	Mass of unit kg	
		H	L	J	J <sub>2</sub>	L <sub>1</sub>	L <sub>2</sub>	J <sub>1</sub>	H <sub>1</sub>	H <sub>2</sub>	B					S
90	UCM318-50	170	1050	990	500	940	—	245	335	—	96	40	M18	19 600	UC318D1	65
	UCM318-60	170	1150	1090	600	1040	—	245	335	—	96	40	M18	19 600	UC318D1	68
	UCM318-70	170	1250	1190	700	1140	—	245	335	—	96	40	M18	19 600	UC318D1	71
	UCM318-80	170	1350	1290	800	1240	—	245	335	—	96	40	M18	19 600	UC318D1	74
	UCM318-90	170	1450	1390	900	1340	—	245	335	—	96	40	M18	19 600	UC318D1	77
95	UCM319-50	185	1180	1100	500	1021	775	300	377	400	103	41	M24	19 600	UC319D1	105
	UCM319-60	185	1280	1200	600	1121	875	300	377	400	103	41	M24	19 600	UC319D1	109
	UCM319-70	185	1380	1300	700	1221	975	300	377	400	103	41	M24	19 600	UC319D1	112
	UCM319-80	185	1480	1400	800	1321	1075	300	377	400	103	41	M24	19 600	UC319D1	116
	UCM319-90	185	1580	1500	900	1421	1175	300	377	400	103	41	M24	19 600	UC319D1	120
100	UCM320-50	200	1220	1140	500	1063	809	320	403	430	108	42	M24	19 600	UC320D1	111
	UCM320-60	200	1320	1240	600	1163	909	320	403	430	108	42	M24	19 600	UC320D1	116
	UCM320-70	200	1420	1340	700	1263	1009	320	403	430	108	42	M24	19 600	UC320D1	120
	UCM320-80	200	1520	1440	800	1363	1109	320	403	430	108	42	M24	19 600	UC320D1	124
	UCM320-90	200	1620	1540	900	1463	1209	320	403	430	108	42	M24	19 600	UC320D1	129

Notes <sup>(1)</sup> If relubricatable type is needed, please order with suffix "D1".

<sup>(2)</sup> The Stretcher Units is designed to only take a horizontal radial load, in line with the adjustment direction. Axial loads or vertical radial loads can deform or break the housing.



# ASPT2 -

## Take-up mini stretcher units™

Set screw type

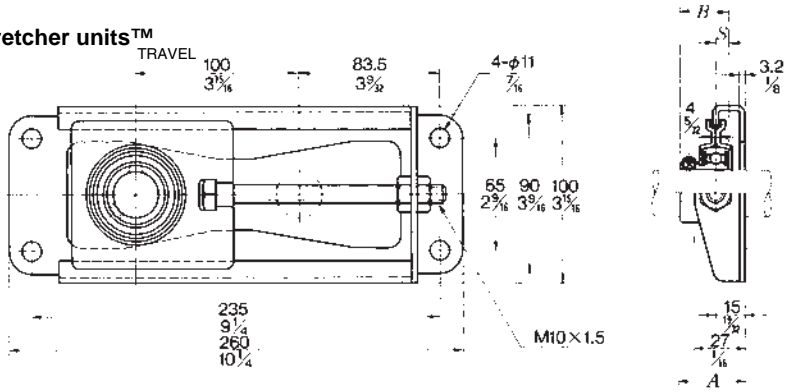

Shaft dia. mm inch	Unit number	Nominal dimensions			Bolt size mm inch	Max. load (1) recommended N lbf
		A	B	S		
12 1/2	ASPT201-10	31	22	6	M10	3 430
	ASPT201-008-10	1 7/32	0.8661	0.236	3/8	770
15 9/16 5/8	ASPT202-10	31	22	6	M10	3 430
	ASPT202-009-10 ASPT202-010-10	1 7/32	0.8661	0.236	3/8	770
17 11/16	ASPT203-10	31	22	6	M10	3 430
	ASPT203-011-10	1 7/32	0.8661	0.236	3/8	770
20 3/4	ASPT204-10	33	25	7	M10	3 430
	ASPT204-012-10	1 19/64	0.9843	0.276	3/8	770
25 13/16 7/8 15/16 1	ASPT205-10	34.5	27	7.5	M10	3 430
	ASPT205-013-10					
	ASPT205-014-10					
	ASPT205-015-10 ASPT205-100-10	1 23/64	1.0630	0.295	3/8	770

Note (1) The Stretcher Units is designed to only take a horizontal radial load, in line with the adjustment direction. Axial loads or vertical radial loads can deform or break the housing.

Bearing number	Mass of unit
	kg lb
AS201	1.1
AS201-008	2.4
AS202	1.1
AS202-009	2.4
AS202-010	
AS203	1.1
AS203-011	2.4
AS204	1.1
AS204-012	2.4
AS205	1.1
AS205-013	
AS205-014	
AS205-015	2.4
AS205-100	

## Cartridge unit, cast housing Set screw type

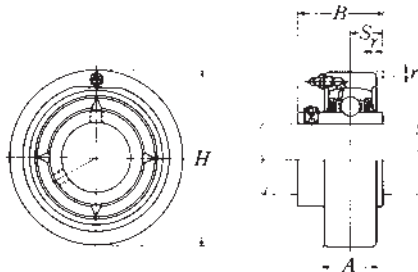

Shaft dia.	Unit number (1)	Nominal dimensions					Bearing number	Housing number	Mass of unit
		mm inch							
mm inch		H	A	r	B	S			kg lb
12 1/2	UCC201D1	72	20	2	31	12.7	UC201D1	C204D1	0.5
	UCC201-008D1	2.8346	25/32	0.079	1.2205	0.500	UC201-008D1	C204D1	1.1
15 9/16 5/8	UCC202D1	72	20	2	31	12.7	UC202D1	C204D1	0.5
	UCC202-009D1	2.8346	25/32	0.079	1.2205	0.500	UC202-009D1	C204D1	1.1
	UCC202-010D1						UC202-010D1	C204D1	
17 11/16	UCC203D1	72	20	2	31	12.7	UC203D1	C204D1	0.5
	UCC203-011D1	2.8346	25/32	0.079	1.2205	0.500	UC203-011D1	C204D1	1.1
20 3/4	UCC204D1	72	20	2	31	12.7	UC204D1	C204D1	0.5
	UCC204-012D1	2.8346	25/32	0.079	1.2205	0.500	UC204-012D1	C204D1	1.1
25 13/16 7/8 15/16 1	UCC205D1	80	22	2	34.1	14.3	UC205D1	C205D1	0.6
	UCC205-013D1						UC205-013D1	C205D1	1.3
	UCC205-014D1	3.1496	55/64	0.079	1.3425	0.563	UC205-014D1	C205D1	
	UCC205-015D1						UC205-015D1	C205D1	
UCC205-100D1						UC205-100D1	C205D1		
30 1 1/16 1 1/8 1 1/16 1 1/4	UCC206D1	85	27	2	38.1	15.9	UC206D1	C206D1	0.8
	UCC206-101D1						UC206-101D1	C206D1	1.8
	UCC206-102D1	3.3465	1 1/16	0.079	1.5000	0.626	UC206-102D1	C206D1	
	UCC206-103D1						UC206-103D1	C206D1	
UCC206-104D1						UC206-104D1	C206D1		
35 1 1/4 1 5/16 1 3/8 1 7/16	UCC207D1	90	28	2	42.9	17.5	UC207D1	C207D1	0.9
	UCC207-104D1						UC207-104D1	C207D1	2.0
	UCC207-105D1	3.5433	1 7/64	0.079	1.6890	0.689	UC207-105D1	C207D1	
	UCC207-106D1						UC207-106D1	C207D1	
	UCC207-107D1						UC207-107D1	C207D1	

Note (1) These numbers indicate relubricatable type. If maintenance free type is needed, please order without suffix "D1".

Remarks Please refer to page A21 for size of grease fitting.

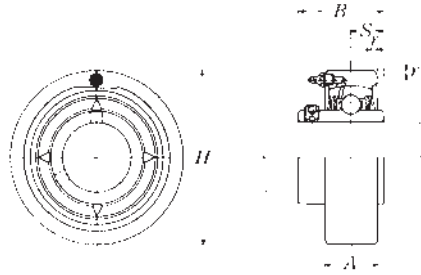

Shaft dia. mm inch	Unit number (*)	Nominal dimensions					Bearing number	Housing number	Mass of unit kg lb
		<i>H</i>	<i>A</i>	<i>r</i>	<i>B</i>	<i>S</i>			
40 1 1/2 1 9/16	<b>UCC208D1</b> <b>UCC208-108D1</b> <b>UCC208-109D1</b>	100 3.9370	30 1 3/16	2.5 0.098	49.2 1.9370	19 0.748	<b>UC208D1</b> UC208-108D1 UC208-109D1	<b>C208D1</b> C208D1 C208D1	1.2 2.6
45 1 5/8 1 11/16 1 3/4	<b>UCC209D1</b> <b>UCC209-110D1</b> <b>UCC209-111D1</b> <b>UCC209-112D1</b>	110 4.3307	31 1 7/32	2.5 0.098	49.2 1.9370	19 0.748	<b>UC209D1</b> UC209-110D1 UC209-111D1 UC209-112D1	<b>C209D1</b> C209D1 C209D1 C209D1	1.5 3.3
50 1 13/16 1 7/8 1 15/16 2	<b>UCC210D1</b> <b>UCC210-113D1</b> <b>UCC210-114D1</b> <b>UCC210-115D1</b> <b>UCC210-200D1</b>	120 4.7244	33 1 19/64	2.5 0.098	51.6 2.0315	19 0.748	<b>UC210D1</b> UC210-113D1 UC210-114D1 UC210-115D1 UC210-200D1	<b>C210D1</b> C210D1 C210D1 C210D1 C210D1	1.9 4.2
55 2 2 1/16 2 1/8 2 3/16	<b>UCC211D1</b> <b>UCC211-200D1</b> <b>UCC211-201D1</b> <b>UCC211-202D1</b> <b>UCC211-203D1</b>	125 4.9213	35 1 3/8	2.5 0.098	55.6 2.1890	22.2 0.874	<b>UC211D1</b> UC211-200D1 UC211-201D1 UC211-202D1 UC211-203D1	<b>C211D1</b> C211D1 C211D1 C211D1 C211D1	2.1 4.6
60 2 1/4 2 5/16 2 3/8 2 7/16	<b>UCC212D1</b> <b>UCC212-204D1</b> <b>UCC212-205D1</b> <b>UCC212-206D1</b> <b>UCC212-207D1</b>	130 5.1181	38 1 1/2	2.5 0.098	65.1 2.5630	25.4 1.000	<b>UC212D1</b> UC212-204D1 UC212-205D1 UC212-206D1 UC212-207D1	<b>C212D1</b> C212D1 C212D1 C212D1 C212D1	2.5 5.5
65 2 1/2 2 9/16	<b>UCC213D1</b> <b>UCC213-208D1</b> <b>UCC213-209D1</b>	140 5.5118	40 1 37/64	3 0.118	65.1 2.5630	25.4 1.000	<b>UC213D1</b> UC213-208D1 UC213-209D1	<b>C213D1</b> C213D1 C213D1	3.0 6.6

**Note (\*)** These numbers indicate relubricatable type. If maintenance free type is needed, please order without suffix "D1".

**Remarks** Please refer to page A21 for size of grease fitting.

## Cartridge unit, cast housing Set screw type

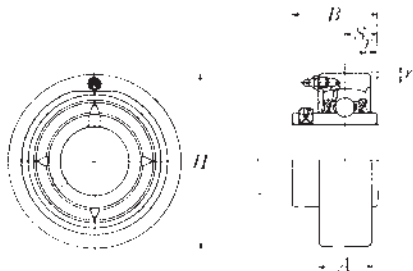

Shaft dia. mm inch	Unit number (1)	Nominal dimensions mm inch					Bearing number	Housing number	Mass of unit kg lb
		H	A	r	B	S			
25 13/16 7/8 15/16 1	<b>UCC305D1</b> <b>UCC305-013D1</b> <b>UCC305-014D1</b> <b>UCC305-015D1</b> <b>UCC305-100D1</b>	90 3.5433	26 1 1/32	2.5 0.098	38 1.4961	15 0.591	<b>UC305D1</b> UC305-013D1 UC305-014D1 UC305-015D1 UC305-100D1	<b>C305D1</b> C305D1 C305D1 C305D1 C305D1	1.0 2.2
30 1 1/16 1 1/8 1 3/16	<b>UCC306D1</b> <b>UCC306-101D1</b> <b>UCC306-102D1</b> <b>UCC306-103D1</b>	100 3.9370	28 1 7/64	2.5 0.098	43 1.6929	17 0.669	<b>UC306D1</b> UC306-101D1 UC306-102D1 UC306-103D1	<b>C306D1</b> C306D1 C306D1 C306D1	1.3 2.9
35 1 1/4 1 5/16 1 3/8 1 7/16	<b>UCC307D1</b> <b>UCC307-104D1</b> <b>UCC307-105D1</b> <b>UCC307-106D1</b> <b>UCC307-107D1</b>	110 4.3307	32 1 17/64	3 0.118	48 1.8898	19 0.748	<b>UC307D1</b> UC307-104D1 UC307-105D1 UC307-106D1 UC307-107D1	<b>C307D1</b> C307D1 C307D1 C307D1 C307D1	1.7 3.7
40 1 1/2 1 7/16	<b>UCC308D1</b> <b>UCC308-108D1</b> <b>UCC308-109D1</b>	120 4.7244	34 1 11/32	3 0.118	52 2.0472	19 0.748	<b>UC308D1</b> UC308-108D1 UC308-109D1	<b>C308D1</b> C308D1 C308D1	2.1 4.6
45 1 5/8 1 11/16 1 3/4	<b>UCC309D1</b> <b>UCC309-110D1</b> <b>UCC309-111D1</b> <b>UCC309-112D1</b>	130 5.1181	38 1 1/2	3.5 0.138	57 2.2441	22 0.866	<b>UC309D1</b> UC309-110D1 UC309-111D1 UC309-112D1	<b>C309D1</b> C309D1 C309D1 C309D1	2.7 6.0
50 1 3/16 1 7/8 1 5/16	<b>UCC310D1</b> <b>UCC310-113D1</b> <b>UCC310-114D1</b> <b>UCC310-115D1</b>	140 5.5118	40 1 37/64	3.5 0.138	61 2.4016	22 0.866	<b>UC310D1</b> UC310-113D1 UC310-114D1 UC310-115D1	<b>C310D1</b> C310D1 C310D1 C310D1	3.3 7.3

**Note (1)** These numbers indicate relubricatable type. If maintenance free type is needed, please order without suffix "D1".

**Remarks** Please refer to page **A21** for size of grease fitting.

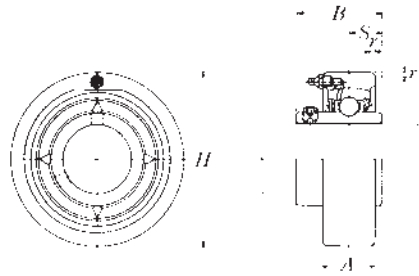

Shaft dia. mm inch	Unit number (1)	Nominal dimensions					Bearing number	Housing number	Mass of unit kg lb
		<i>H</i>	<i>A</i>	<i>r</i>	<i>B</i>	<i>S</i>			
55	<b>UCC311D1</b>	150	44	3.5	66	25	<b>UC311D1</b>	<b>C311D1</b>	4.0
2	<b>UCC311-200D1</b>						UC311-200D1	C311D1	
2 1/16	<b>UCC311-201D1</b>	5.9055	1 47/64	0.138	2.5984	0.984	UC311-201D1	C311D1	8.8
2 1/8	<b>UCC311-202D1</b>						UC311-202D1	C311D1	
2 3/16	<b>UCC311-203D1</b>						UC311-203D1	C311D1	
60	<b>UCC312D1</b>	160	46	3.5	71	26	<b>UC312D1</b>	<b>C312D1</b>	4.8
2 1/4	<b>UCC312-204D1</b>						UC312-204D1	C312D1	
2 5/16	<b>UCC312-205D1</b>	6.2992	1 13/16	0.138	2.7953	1.024	UC312-205D1	C312D1	11
2 3/8	<b>UCC312-206D1</b>						UC312-206D1	C312D1	
2 7/16	<b>UCC312-207D1</b>						UC312-207D1	C312D1	
65	<b>UCC313D1</b>	170	50	3.5	75	30	<b>UC313D1</b>	<b>C313D1</b>	5.8
2 1/2	<b>UCC313-208D1</b>	6.6929	1 31/32	0.138	2.9528	1.181	UC313-208D1	C313D1	13
2 9/16	<b>UCC313-209D1</b>						UC313-209D1	C313D1	
70	<b>UCC314D1</b>	180	52	4	78	33	<b>UC314D1</b>	<b>C314D1</b>	6.8
2 5/8	<b>UCC314-210D1</b>						UC314-210D1	C314D1	
2 11/16	<b>UCC314-211D1</b>	7.0866	2 3/64	0.157	3.0709	1.299	UC314-211D1	C314D1	15
2 3/4	<b>UCC314-212D1</b>						UC314-212D1	C314D1	
75	<b>UCC315D1</b>	190	55	4	82	32	<b>UC315D1</b>	<b>C315D1</b>	7.9
2 13/16	<b>UCC315-213D1</b>						UC315-213D1	C315D1	
2 7/8	<b>UCC315-214D1</b>	7.4803	2 11/64	0.157	3.2283	1.260	UC315-214D1	C315D1	17
2 15/16	<b>UCC315-215D1</b>						UC315-215D1	C315D1	
3	<b>UCC315-300D1</b>						UC315-300D1	C315D1	
80	<b>UCC316D1</b>	200	60	4	86	34	<b>UC316D1</b>	<b>C316D1</b>	9.3
3 1/16	<b>UCC316-301D1</b>						UC316-301D1	C316D1	
3 1/8	<b>UCC316-302D1</b>	7.8740	2 23/64	0.157	3.3858	1.339	UC316-302D1	C316D1	21
3 3/16	<b>UCC316-303D1</b>						UC316-303D1	C316D1	

Note (1) These numbers indicate relubricatable type. If maintenance free type is needed, please order without suffix "D1".

Remarks Please refer to page A21 for size of grease fitting.

## Cartridge unit, cast housing Set screw type

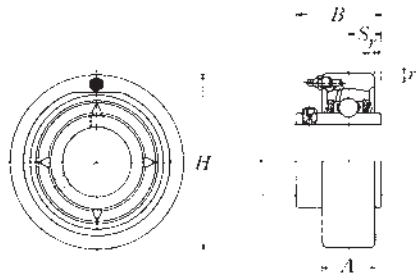

Shaft dia. mm inch	Unit number (1)	Nominal dimensions mm inch					Bearing number	Housing number	Mass of unit kg lb
		H	A	r	B	S			
85 3 1/4	<b>UCC317D1</b> <b>UCC317-304D1</b>	215	64	4	96	40	<b>UC317D1</b> UC317-304D1	<b>C317D1</b> C317D1	11
3 5/16 3 7/16	<b>UCC317-305D1</b> <b>UCC317-307D1</b>	8.4646	2 33/64	0.157	3.7795	1.575	UC317-305D1 UC317-307D1	C317D1 C317D1	24
90 3 1/2	<b>UCC318D1</b> <b>UCC318-308D1</b>	225	66	4	96	40	<b>UC318D1</b> UC318-308D1	<b>C318D1</b> C318D1	13 29
95 3 5/8 3 11/16 3 3/4	<b>UCC319D1</b> <b>UCC319-310D1</b> <b>UCC319-311D1</b> <b>UCC319-312D1</b>	240	72	4	103	41	<b>UC319D1</b> UC319-310D1 UC319-311D1 UC319-312D1	<b>C319D1</b> C319D1 C319D1 C319D1	16 35
100 3 13/16 3 7/8 3 15/16 4	<b>UCC320D1</b> <b>UCC320-313D1</b> <b>UCC320-314D1</b> <b>UCC320-315D1</b> <b>UCC320-400D1</b>	260	75	4	108	42	<b>UC320D1</b> UC320-313D1 UC320-314D1 UC320-315D1 UC320-400D1	<b>C320D1</b> C320D1 C320D1 C320D1 C320D1	20 44
105	<b>UCC321D1</b>	260	75	4	112	44	<b>UC321D1</b>	<b>C321D1</b>	19
110	<b>UCC322D1</b>	300	80	5	117	46	<b>UC322D1</b>	<b>C322D1</b>	29
120	<b>UCC324D1</b>	320	90	5	126	51	<b>UC324D1</b>	<b>C324D1</b>	36
130	<b>UCC326D1</b>	340	100	5	135	54	<b>UC326D1</b>	<b>C326D1</b>	43
140	<b>UCC328D1</b>	360	100	5	145	59	<b>UC328D1</b>	<b>C328D1</b>	50

**Note** (1) These numbers indicate relubricatable type. If maintenance free type is needed, please order without suffix "D1".

**Remarks** Please refer to page **A21** for size of grease fitting.





## Cartridge unit, cast housing Set screw type

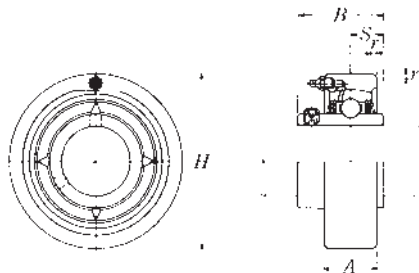

Shaft dia.  mm inch	Unit number (1)	Nominal dimensions					Bearing number	Housing number	Mass of unit  kg lb
		<i>H</i>	<i>A</i>	<i>r</i>	<i>B</i>	<i>S</i>			
25  13/16 7/8 15/16 1	<b>UCCX05D1</b> <b>UCCX05-013D1</b> <b>UCCX05-014D1</b> <b>UCCX05-015D1</b> <b>UCCX05-100D1</b>	90  3.5433	27  1 1/16	2  0.079	38.1  1.5000	15.9  0.626	<b>UCX05D1</b> UCX05-013D1 UCX05-014D1 UCX05-015D1 UCX05-100D1	<b>CX05D1</b> CX05D1 CX05D1 CX05D1 CX05D1	1.1  2.4
30  1 1/16 1 1/8 1 3/8 1 1/4	<b>UCCX06D1</b> <b>UCCX06-101D1</b> <b>UCCX06-102D1</b> <b>UCCX06-103D1</b> <b>UCCX06-104D1</b>	100  3.9370	30  1 3/16	2.5  0.098	42.9  1.6890	17.5  0.689	<b>UCX06D1</b> UCX06-101D1 UCX06-102D1 UCX06-103D1 UC207-104D1	<b>CX06D1</b> CX06D1 CX06D1 CX06D1 CX06D1	1.6  3.5
35  1 5/16 1 3/8 1 7/16	<b>UCCX07D1</b> <b>UCCX07-105D1</b> <b>UCCX07-106D1</b> <b>UCCX07-107D1</b>	110  4.3307	34  1 11/32	2.5  0.098	49.2  1.9370	19  0.748	<b>UCX07D1</b> UCX07-105D1 UCX07-106D1 UCX07-107D1	<b>CX07D1</b> CX07D1 CX07D1 CX07D1	1.8  4.0
40  1 1/2 1 7/16	<b>UCCX08D1</b> <b>UCCX08-108D1</b> <b>UCCX08-109D1</b>	120  4.7244	38  1 1/2	2.5  0.098	49.2  1.9370	19  0.748	<b>UCX08D1</b> UCX08-108D1 UCX08-109D1	<b>CX08D1</b> CX08D1 CX08D1	2.5  5.5
45  1 5/8 1 11/16 1 3/4 1 13/16	<b>UCCX09D1</b> <b>UCCX09-110D1</b> <b>UCCX09-111D1</b> <b>UCCX09-112D1</b> <b>UCCX09-113D1</b>	120  4.7244	38  1 1/2	2.5  0.098	51.6  2.0315	19  0.748	<b>UCX09D1</b> UCX09-110D1 UCX09-111D1 UCX09-112D1 UC210-113D1	<b>CX09D1</b> CX09D1 CX09D1 CX09D1 CX09D1	2.2  4.9
50  1 7/8 1 15/16 2	<b>UCCX10D1</b> <b>UCCX10-114D1</b> <b>UCCX10-115D1</b> <b>UCCX10-200D1</b>	130  5.1181	40  1 37/64	2.5  0.098	55.6  2.1890	22.2  0.874	<b>UCX10D1</b> UCX10-114D1 UCX10-115D1 UC211-200D1	<b>CX10D1</b> CX10D1 CX10D1 CX10D1	2.7  6.0

Note (1) These numbers indicate relubricatable type. If maintenance free type is needed, please order without suffix "D1".

Remarks Please refer to page A21 for size of grease fitting.

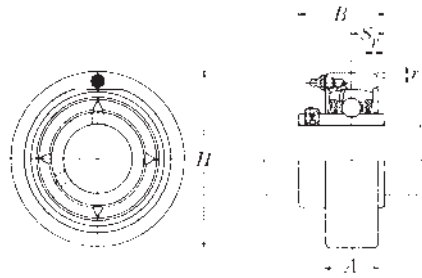

Shaft dia. mm inch	Unit number (1)	Nominal dimensions					Bearing number	Housing number	Mass of unit kg lb
		<i>H</i>	<i>A</i>	<i>r</i>	<i>B</i>	<i>S</i>			
55 2 1/16 2 1/8	<b>UCCX11D1</b> <b>UCCX11-201D1</b> <b>UCCX11-202D1</b>	150	42	3	65.1	25.4	<b>UCX11D1</b> UCX11-201D1 UCX11-202D1	<b>CX11D1</b> CX11D1 CX11D1	4.1
2 3/16 2 1/4 2 5/16	<b>UCCX11-203D1</b> <b>UCCX11-204D1</b> <b>UCCX11-205D1</b>	5.9055	1 21/32	0.118	2.5630	1.000	UCX11-203D1 UC212-204D1 UC212-205D1	CX11D1 CX11D1 CX11D1	9.0
60 2 3/8 2 7/16	<b>UCCX12D1</b> <b>UCCX12-206D1</b> <b>UCCX12-207D1</b>	160	44	3	65.1	25.4	<b>UCX12D1</b> UCX12-206D1 UCX12-207D1	<b>CX12D1</b> CX12D1 CX12D1	3.9 8.6

Note (1) These numbers indicate relubricatable type. If maintenance free type is needed, please order without suffix "D1".

Remarks Please refer to page A21 for size of grease fitting.

## Pillow block unit, cast housing Eccentric locking collar type

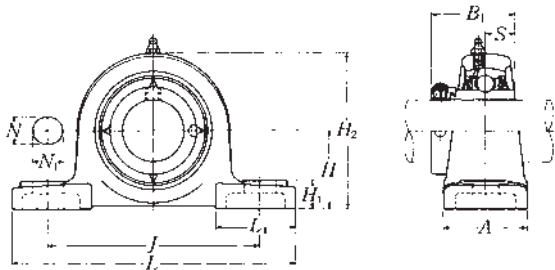

Shaft dia.  mm inch	Unit number (1)	Nominal dimensions											Bolt size  mm inch
		mm inch											
		H	L	J	A	N	N <sub>1</sub>	H <sub>1</sub>	H <sub>2</sub>	L <sub>1</sub>	B <sub>1</sub>	S	
20  3/4	UEL204D1W3	33.3	127	95	38	13	16	14	65	42	43.7	17.1	M10
	UEL204-012D1W3	1 5/16	5	3 3/4	1 1/2	1/2	5/8	9/16	2 9/16	1 21/32	1.720	0.673	3/8
25  13/16 7/8 15/16	UEL205D1W3	36.5	140	105	38	13	16	15	71	42	44.4	17.45	M10
	UEL205-013D1W3												
	UEL205-014D1W3												
	UEL205-015D1W3	1 7/16	5 1/2	4 1/8	1 1/2	1/2	5/8	19/32	2 25/32	1 21/32	1.748	0.687	3/8
1	UEL205-100D1W3												
30  1 1/16 1 1/8 1 1/16 1 1/4	UEL206D1W3	42.9	165	121	48	17	20	17	83	54	48.4	18.25	M14
	UEL206-101D1W3												
	UEL206-102D1W3												
	UEL206-103D1W3	1 11/16	6 1/2	4 3/4	1 7/8	2 1/32	25/32	2 1/32	3 9/32	2 1/8	1.906	0.719	1/2
1 1/4	UEL206-104D1W3												
35  1 1/4 1 1/16 1 3/8 1 7/16	UEL207D1W3	47.6	167	127	48	17	20	18	93	54	51.1	18.8	M14
	UEL207-104D1W3												
	UEL207-105D1W3												
	UEL207-106D1W3	1 7/8	6 9/16	5	1 7/8	2 1/32	25/32	23/32	3 21/32	2 1/8	2.012	0.740	1/2
1 7/16	UEL207-107D1W3												
40  1 1/2 1 9/16	UEL208D1W3	49.2	184	137	54	17	20	18	98	52	56.3	21.4	M14
	UEL208-108D1W3												
	UEL208-109D1W3	1 15/16	7 1/4	5 13/32	2 1/8	2 1/32	25/32	23/32	3 27/32	2 1/16	2.217	0.843	1/2
45  1 5/8 1 1/16 1 3/4	UEL209D1W3	54	190	146	54	17	20	20	106	60	56.3	21.4	M14
	UEL209-110D1W3												
	UEL209-111D1W3												
	UEL209-112D1W3	2 1/8	7 15/32	5 3/4	2 1/8	2 1/32	25/32	25/32	4 3/16	2 3/8	2.217	0.843	1/2
50  1 13/16 1 7/8 1 5/16 2	UEL210D1W3	57.2	206	159	60	20	23	21	114	65	62.7	24.6	M16
	UEL210-113D1W3												
	UEL210-114D1W3												
	UEL210-115D1W3	2 1/4	8 1/8	6 1/4	2 3/8	25/32	29/32	13/16	4 1/2	2 9/16	2.469	0.969	5/8
2	UEL210-200D1W3												

Note (1) These numbers indicate relubricatable type. If maintenance free type is needed, please order without suffix "D1".

Remarks Please refer to page A21 for size of grease fitting.

Bearing number	Housing number	Mass of unit
		kg lb
UEL204D1W3	P204D1	0.8
UEL204-012D1W3	P204D1	1.8
UEL205D1W3	P205D1	0.9
UEL205-013D1W3	P205D1	2.0
UEL205-014D1W3	P205D1	
UEL205-015D1W3	P205D1	
UEL205-100D1W3	P205D1	
UEL206D1W3	P206D1	1.5
UEL206-101D1W3	P206D1	3.3
UEL206-102D1W3	P206D1	
UEL206-103D1W3	P206D1	
UEL206-104D1W3	P206D1	
UEL207D1W3	P207D1	1.8
UEL207-104D1W3	P207D1	4.0
UEL207-105D1W3	P207D1	
UEL207-106D1W3	P207D1	
UEL207-107D1W3	P207D1	
UEL208D1W3	P208D1	2.1
UEL208-108D1W3	P208D1	4.6
UEL208-109D1W3	P208D1	
UEL209D1W3	P209D1	2.3
UEL209-110D1W3	P209D1	5.1
UEL209-111D1W3	P209D1	
UEL209-112D1W3	P209D1	
UEL210D1W3	P210D1	2.9
UEL210-113D1W3	P210D1	6.4
UEL210-114D1W3	P210D1	
UEL210-115D1W3	P210D1	
UEL210-200D1W3	P210D1	

## Pillow block unit, cast housing Eccentric locking collar type

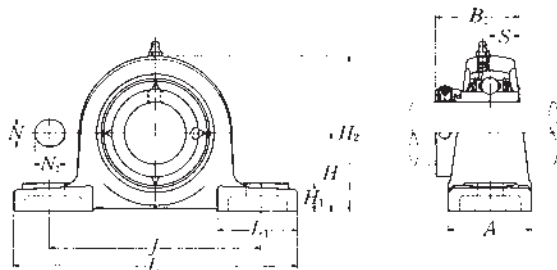

Shaft dia. mm inch	Unit number (1)	Nominal dimensions											Bolt size mm inch
		mm inch											
		H	L	J	A	N	N <sub>1</sub>	H <sub>1</sub>	H <sub>2</sub>	L <sub>1</sub>	B <sub>1</sub>	S	
55 2 2 1/16 2 1/8 2 3/16	<b>UEL211D1W3</b> <b>UEL211-200D1W3</b> <b>UEL211-201D1W3</b> <b>UEL211-202D1W3</b> <b>UEL211-203D1W3</b>	63.5 2 1/2	219 8 5/8	171 6 23/32	60 2 3/8	20 25/32	23 29/32	23 29/32	126 4 31/32	65 2 9/16	71.4 2.811	27.75 1.093	M16 5/8
60 2 1/4 2 5/16 2 3/8 2 7/16	<b>UEL212D1W3</b> <b>UEL212-204D1W3</b> <b>UEL212-205D1W3</b> <b>UEL212-206D1W3</b> <b>UEL212-207D1W3</b>	69.8 2 3/4	241 9 1/2	184 7 1/4	70 2 3/4	20 25/32	23 29/32	25 3 1/32	138 5 7/16	70 2 3/4	77.8 3.063	30.95 1.219	M16 5/8
65 2 1/2 2 5/16	<b>UEL213D1W3</b> <b>UEL213-208D1W3</b> <b>UEL213-209D1W3</b>	76.2 3	265 10 7/16	203 8	70 2 3/4	25 3 1/32	28 1 3/32	27 1 1/16	151 5 15/16	77 3 3/32	85.7 3.374	34.15 1.344	M20 3/4
70 2 5/8 2 11/16 2 3/4	<b>UEL214D1W3</b> <b>UEL214-210D1W3</b> <b>UEL214-211D1W3</b> <b>UEL214-212D1W3</b>	79.4 3 1/8	266 10 15/32	210 8 9/32	72 2 27/32	25 3 1/32	28 1 3/32	27 1 1/16	157 6 3/16	77 3 3/32	85.7 3.374	34.15 1.344	M20 3/4
75 2 13/16 2 7/8 2 5/16 3	<b>UEL215D1W3</b> <b>UEL215-213D1W3</b> <b>UEL215-214D1W3</b> <b>UEL215-215D1W3</b> <b>UEL215-300D1W3</b>	82.6 3 1/4	275 10 13/16	217 8 17/32	74 2 29/32	25 3 1/32	28 1 3/32	28 1 3/32	163 6 13/32	80 3 5/32	92 3.622	37.3 1.469	M20 3/4

Note (1) These numbers indicate relubricatable type. If maintenance free type is needed, please order without suffix "D1".

Remarks Please refer to page A21 for size of grease fitting.

Bearing number	Housing number	Mass of unit
		kg lb
UEL211D1W3	P211D1	3.7
UEL211-200D1W3	P211D1	8.2
UEL211-201D1W3	P211D1	
UEL211-202D1W3	P211D1	
UEL211-203D1W3	P211D1	
UEL212D1W3	P212D1	5.0
UEL212-204D1W3	P212D1	11
UEL212-205D1W3	P212D1	
UEL212-206D1W3	P212D1	
UEL212-207D1W3	P212D1	
UEL213D1W3	P213D1	6.2
UEL213-208D1W3	P213D1	14
UEL213-209D1W3	P213D1	
UEL214D1W3	P214D1	6.9
UEL214-210D1W3	P214D1	15
UEL214-211D1W3	P214D1	
UEL214-212D1W3	P214D1	
UEL215D1W3	P215D1	7.6
UEL215-213D1W3	P215D1	17
UEL215-214D1W3	P215D1	
UEL215-215D1W3	P215D1	
UEL215-300D1W3	P215D1	

## Pillow block unit, cast housing Eccentric locking collar type

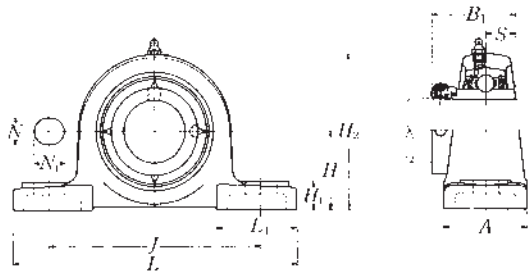

Shaft dia. mm inch	Unit number (1)	Nominal dimensions											Bolt size mm inch
		mm inch											
		H	L	J	A	N	N <sub>1</sub>	H <sub>1</sub>	H <sub>2</sub>	L <sub>1</sub>	B <sub>1</sub>	S	
25 1 <sup>13</sup> / <sub>16</sub> 7 <sup>7</sup> / <sub>8</sub> 1 <sup>15</sup> / <sub>16</sub> 1	UELP305D1W3	45	175	132	45	17	20	15	85	54	46.8	16.7	M14
	UELP305-013D1W3												
	UELP305-014D1W3												
	UELP305-015D1W3	1 <sup>49</sup> / <sub>64</sub>	6 <sup>7</sup> / <sub>8</sub>	5 <sup>3</sup> / <sub>16</sub>	1 <sup>25</sup> / <sub>32</sub>	2 <sup>1</sup> / <sub>32</sub>	2 <sup>25</sup> / <sub>32</sub>	1 <sup>19</sup> / <sub>32</sub>	3 <sup>1</sup> / <sub>32</sub>	2 <sup>1</sup> / <sub>8</sub>	1.843	0.657	1/2
	UELP305-100D1W3												
30 1 <sup>1</sup> / <sub>16</sub> 1 <sup>1</sup> / <sub>8</sub> 1 <sup>3</sup> / <sub>16</sub>	UELP306D1W3	50	180	140	50	17	20	18	95	54	50	17.5	M14
	UELP306-101D1W3												
	UELP306-102D1W3	1 <sup>31</sup> / <sub>32</sub>	7 <sup>3</sup> / <sub>32</sub>	5 <sup>1</sup> / <sub>2</sub>	1 <sup>31</sup> / <sub>32</sub>	2 <sup>1</sup> / <sub>32</sub>	2 <sup>25</sup> / <sub>32</sub>	2 <sup>29</sup> / <sub>32</sub>	3 <sup>3</sup> / <sub>4</sub>	2 <sup>1</sup> / <sub>8</sub>	1.969	0.689	1/2
	UELP306-103D1W3												
35 1 <sup>1</sup> / <sub>4</sub> 1 <sup>5</sup> / <sub>16</sub> 1 <sup>3</sup> / <sub>8</sub> 1 <sup>7</sup> / <sub>16</sub>	UELP307D1W3	56	210	160	56	17	25	20	106	60	51.6	18.3	M14
	UELP307-104D1W3												
	UELP307-105D1W3	2 <sup>13</sup> / <sub>64</sub>	8 <sup>9</sup> / <sub>32</sub>	6 <sup>5</sup> / <sub>16</sub>	2 <sup>7</sup> / <sub>32</sub>	2 <sup>1</sup> / <sub>32</sub>	3 <sup>1</sup> / <sub>32</sub>	2 <sup>25</sup> / <sub>32</sub>	4 <sup>3</sup> / <sub>16</sub>	2 <sup>3</sup> / <sub>8</sub>	2.031	0.720	1/2
	UELP307-106D1W3												
	UELP307-107D1W3												
40 1 <sup>1</sup> / <sub>2</sub> 1 <sup>7</sup> / <sub>16</sub>	UELP308D1W3	60	220	170	60	17	27	22	116	60	57.1	19.8	M14
	UELP308-108D1W3												
	UELP308-109D1W3	2 <sup>23</sup> / <sub>64</sub>	8 <sup>21</sup> / <sub>32</sub>	6 <sup>1</sup> / <sub>16</sub>	2 <sup>3</sup> / <sub>8</sub>	2 <sup>1</sup> / <sub>32</sub>	1 <sup>1</sup> / <sub>16</sub>	7 <sup>7</sup> / <sub>8</sub>	4 <sup>9</sup> / <sub>16</sub>	2 <sup>3</sup> / <sub>8</sub>	2.248	0.780	1/2
45 1 <sup>5</sup> / <sub>8</sub> 1 <sup>11</sup> / <sub>16</sub> 1 <sup>3</sup> / <sub>4</sub>	UELP309D1W3	67	245	190	67	20	30	24	129	65	58.7	19.8	M16
	UELP309-110D1W3												
	UELP309-111D1W3	2 <sup>41</sup> / <sub>64</sub>	9 <sup>21</sup> / <sub>32</sub>	7 <sup>15</sup> / <sub>32</sub>	2 <sup>5</sup> / <sub>8</sub>	2 <sup>25</sup> / <sub>32</sub>	1 <sup>3</sup> / <sub>16</sub>	1 <sup>15</sup> / <sub>16</sub>	5 <sup>3</sup> / <sub>32</sub>	2 <sup>9</sup> / <sub>16</sub>	2.311	0.780	5/8
	UELP309-112D1W3												
50 1 <sup>3</sup> / <sub>16</sub> 1 <sup>1</sup> / <sub>6</sub> 1 <sup>15</sup> / <sub>16</sub>	UELP310D1W3	75	275	212	75	20	35	27	143	75	66.6	24.6	M16
	UELP310-113D1W3												
	UELP310-114D1W3	2 <sup>61</sup> / <sub>64</sub>	10 <sup>13</sup> / <sub>16</sub>	8 <sup>1</sup> / <sub>32</sub>	2 <sup>15</sup> / <sub>16</sub>	2 <sup>25</sup> / <sub>32</sub>	1 <sup>3</sup> / <sub>8</sub>	1 <sup>1</sup> / <sub>16</sub>	5 <sup>5</sup> / <sub>8</sub>	2 <sup>15</sup> / <sub>16</sub>	2.622	0.969	5/8
	UELP310-115D1W3												

Note (1) These numbers indicate relubricatable type. If maintenance free type is needed, please order without suffix "D1".

Remarks Please refer to page A21 for size of grease fitting.

Bearing number	Housing number	Mass of unit
		kg lb
UEL305D1W3	P305D1	1.5
UEL305-013D1W3	P305D1	
UEL305-014D1W3	P305D1	3.3
UEL305-015D1W3	P305D1	
UEL305-100D1W3	P305D1	
UEL306D1W3	P306D1	1.9
UEL306-101D1W3	P306D1	
UEL306-102D1W3	P306D1	4.2
UEL306-103D1W3	P306D1	
UEL307D1W3	P307D1	2.6
UEL307-104D1W3	P307D1	
UEL307-105D1W3	P307D1	5.7
UEL307-106D1W3	P307D1	
UEL307-107D1W3	P307D1	
UEL308D1W3	P308D1	3.2
UEL308-108D1W3	P308D1	7.1
UEL308-109D1W3	P308D1	
UEL309D1W3	P309D1	4.2
UEL309-110D1W3	P309D1	
UEL309-111D1W3	P309D1	9.3
UEL309-112D1W3	P309D1	
UEL310D1W3	P310D1	5.8
UEL310-113D1W3	P310D1	
UEL310-114D1W3	P310D1	13
UEL310-115D1W3	P310D1	



## Pillow block unit, cast housing Eccentric locking collar type

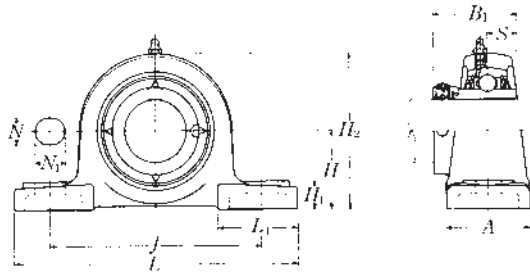

Shaft dia. mm inch	Unit number (1)	Nominal dimensions											Bolt size mm inch
		mm inch											
		H	L	J	A	N	N <sub>1</sub>	H <sub>1</sub>	H <sub>2</sub>	L <sub>1</sub>	B <sub>1</sub>	S	
55 2 2 1/16 2 1/8 2 3/16	<b>UEL311D1W3</b> <b>UEL311-200D1W3</b> <b>UEL311-201D1W3</b> <b>UEL311-202D1W3</b> <b>UEL311-203D1W3</b>	80 3 5/32	310 12 7/32	236 9 9/32	80 3 3/32	20 25/32	38 1 1/2	30 1 3/16	154 6 1/16	85 3 1/32	73 2.874	27.8 1.094	M16 5/8
60 2 1/4 2 5/16 2 3/8 2 7/16	<b>UEL312D1W3</b> <b>UEL312-204D1W3</b> <b>UEL312-205D1W3</b> <b>UEL312-206D1W3</b> <b>UEL312-207D1W3</b>	85 3 1/32	330 13	250 9 27/32	85 3 1/32	25 3 1/32	38 1 1/2	32 1 1/4	165 6 1/2	95 3 3/4	79.4 3.126	30.95 1.219	M20 3/4
65 2 1/2 2 9/16	<b>UEL313D1W3</b> <b>UEL313-208D1W3</b> <b>UEL313-209D1W3</b>	90 3 35/64	340 13 3/8	260 10 1/4	90 3 17/32	25 3 1/32	38 1 1/2	33 1 5/16	176 6 15/16	105 4 1/8	85.7 3.374	32.55 1.281	M20 3/4
70 2 5/8 2 11/16 2 3/4	<b>UEL314D1W3</b> <b>UEL314-210D1W3</b> <b>UEL314-211D1W3</b> <b>UEL314-212D1W3</b>	95 3 47/64	360 14 3/16	280 11 1/32	90 3 17/32	27 1 1/16	40 1 9/16	35 1 3/8	187 7 3/8	105 4 1/8	92.1 3.626	34.15 1.344	M22 7/8
75 2 3/16 2 7/8 2 5/16 3	<b>UEL315D1W3</b> <b>UEL315-213D1W3</b> <b>UEL315-214D1W3</b> <b>UEL315-215D1W3</b> <b>UEL315-300D1W3</b>	100 3 15/16	380 14 31/32	290 11 13/32	100 3 15/16	27 1 1/16	40 1 9/16	35 1 3/8	198 7 25/32	110 4 11/32	100 3.937	37.3 1.469	M22 7/8
80 3 1/16 3 1/8 3 3/16	<b>UEL316D1W3</b> <b>UEL316-301D1W3</b> <b>UEL316-302D1W3</b> <b>UEL316-303D1W3</b>	106 4 11/64	400 15 3/4	300 11 13/16	110 4 11/32	27 1 1/16	40 1 9/16	40 1 9/16	210 8 3/32	110 4 11/32	106.4 4.189	40.5 1.594	M22 7/8

Note (1) These numbers indicate relubricatable type. If maintenance free type is needed, please order without suffix "D1".

Remarks Please refer to page A21 for size of grease fitting.

Bearing number	Housing number	Mass of unit
		kg lb
UEL311D1W3	P311D1	7.6
UEL311-200D1W3	P311D1	17
UEL311-201D1W3	P311D1	
UEL311-202D1W3	P311D1	
UEL311-203D1W3	P311D1	
UEL312D1W3	P312D1	
UEL312-204D1W3	P312D1	21
UEL312-205D1W3	P312D1	
UEL312-206D1W3	P312D1	
UEL312-207D1W3	P312D1	
UEL313D1W3	P313D1	
UEL313-208D1W3	P313D1	24
UEL313-209D1W3	P313D1	
UEL314D1W3	P314D1	12
UEL314-210D1W3	P314D1	26
UEL314-211D1W3	P314D1	
UEL314-212D1W3	P314D1	
UEL315D1W3	P315D1	15
UEL315-213D1W3	P315D1	33
UEL315-214D1W3	P315D1	
UEL315-215D1W3	P315D1	
UEL315-300D1W3	P315D1	
UEL316D1W3	P316D1	
UEL316-301D1W3	P316D1	40
UEL316-302D1W3	P316D1	
UEL316-303D1W3	P316D1	

## Pillow block unit, cast housing Eccentric locking collar type

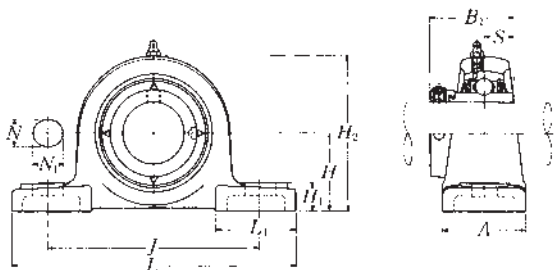

Shaft dia. mm inch	Unit number (1)	Nominal dimensions											Bolt size mm inch
		mm inch											
		H	L	J	A	N	N <sub>1</sub>	H <sub>1</sub>	H <sub>2</sub>	L <sub>1</sub>	B <sub>1</sub>	S	
85 3 1/4	UEL317D1W3	112	420	320	110	33	45	40	220	120	109.5	42.05	M27
3 5/16	UEL317-304D1W3	4 13/32	16 17/32	12 19/32	4 11/32	1 5/16	1 25/32	1 9/16	8 21/32	4 23/32	4.311	1.656	1
3 7/16	UEL317-305D1W3												
3 7/8	UEL317-307D1W3												
90 3 7/16	UEL318D1W3	118	430	330	110	33	45	45	235	120	115.9	43.65	M27
3 1/2	UEL318-307D1W3	4 11/64	16 15/16	13	4 11/32	1 5/16	1 25/32	1 25/32	9 1/4	4 23/32	4.563	1.719	1
	UEL318-308D1W3												
95 3 5/8	UEL319D1W3	125	470	360	120	36	50	45	250	125	122.3	38.9	M30
3 11/16	UEL319-310D1W3	4 59/64	18 1/2	14 3/16	4 23/32	1 13/32	1 31/32	1 25/32	9 27/32	4 29/32	4.815	1.531	1 1/8
3 13/16	UEL319-311D1W3												
3 3/4	UEL319-312D1W3												
100 3 3/8	UEL320D1W3	140	490	380	120	36	50	50	275	130	128.6	50	M30
3 7/8	UEL320-313D1W3												
3 15/16	UEL320-314D1W3	5 33/64	19 9/32	14 31/32	4 23/32	1 13/32	1 31/32	1 31/32	10 13/16	5 1/8	5.063	1.969	1 1/8
4	UEL320-315D1W3												
	UEL320-400D1W3												
105 3 3/8	UEL321D1W3	140	490	380	120	36	50	50	280	130	139.7	48.4	M30
110 4 1/8	UEL322D1W3	150	520	400	140	40	55	55	300	135	141.3	49.2	M33

Note (1) These numbers indicate relubricatable type. If maintenance free type is needed, please order without suffix "D1".

Remarks Please refer to page A21 for size of grease fitting.

Bearing number	Housing number	Mass of unit
		kg lb
UEL317D1W3	P317D1	21
UEL317-304D1W3	P317D1	46
UEL317-305D1W3	P317D1	
UEL317-307D1W3	P317D1	
UEL318D1W3	P318D1	23
UEL318-307D1W3	P318D1	51
UEL318-308D1W3	P318D1	
UEL319D1W3	P319D1	28
UEL319-310D1W3	P319D1	62
UEL319-311D1W3	P319D1	
UEL319-312D1W3	P319D1	
UEL320D1W3	P320D1	35
UEL320-313D1W3	P320D1	77
UEL320-314D1W3	P320D1	
UEL320-315D1W3	P320D1	
UEL320-400D1W3	P320D1	
UEL321D1W3	P321D1	37
UEL322D1W3	P322D1	46

## Pillow block unit, cast housing low center height Eccentric locking collar type

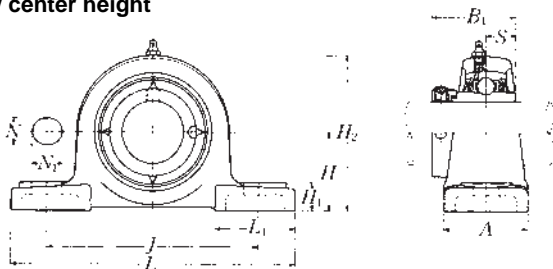

Shaft dia.  mm inch	Unit number <sup>(1)</sup> / <sub>(2)</sub> / <sub>(3)</sub>	Nominal dimensions											Bolt size  mm inch
		mm inch											
		H	L	J	A	N	N <sub>1</sub>	H <sub>1</sub>	H <sub>2</sub>	L <sub>1</sub>	B <sub>1</sub>	S	
20  3/4	UELPL204D1W3	31.75	127	95	38	13	16	14	64	42	43.7	17.1	M10
	UELPL204-012D1W3	1 1/4	5	3 3/4	1 1/2	1/2	5/8	9/16	2 17/32	1 21/32	1.720	0.673	3/8
25  1 13/16 7/8 1 15/16 1	UELPL205D1W3	33.34	140	105	38	13	16	15	68	42	44.4	17.45	M10
	UELPL205-013D1W3												
	UELPL205-014D1W3												
	UELPL205-015D1W3	1 5/16	5 1/2	4 1/8	1 1/2	1/2	5/8	19/32	2 1/16	1 21/32	1.748	0.687	3/8
	UELPL205-100D1W3												
30  1 1/16 1 1/8 1 7/16 1 1/4	UELPL206D1W3	39.69	165	121	48	17	20	17	80	54	48.4	18.25	M14
	UELPL206-101D1W3												
	UELPL206-102D1W3												
	UELPL206-103D1W3	1 9/16	6 1/2	4 3/4	1 7/8	2 1/32	25/32	2 1/32	3 5/32	2 1/8	1.906	0.719	1/2
	UELPL206-104D1W3												
35  1 1/4 1 5/16 1 3/8 1 7/16	UELPL207D1W3	46.04	167	127	48	17	20	18	91	54	51.1	18.8	M14
	UELPL207-104D1W3												
	UELPL207-105D1W3												
	UELPL207-106D1W3	1 13/16	6 9/16	5	1 7/8	2 1/32	25/32	23/32	3 19/32	2 1/8	2.012	0.740	1/2
	UELPL207-107D1W3												
45  1 5/8 1 11/16 1 3/4	UELPL209D1W3	52.39	190	146	54	17	20	20	104	60	56.3	21.4	M14
	UELPL209-110D1W3												
	UELPL209-111D1W3	2 1/16	7 15/32	5 3/4	2 1/8	2 1/32	25/32	25/32	4 3/32	2 3/8	2.217	0.843	1/2
	UELPL209-112D1W3												
50  1 13/16 1 7/8 1 15/16 2	UELPL210D1W3	55.56	206	159	60	20	23	21	112	65	62.7	24.6	M16
	UELPL210-113D1W3												
	UELPL210-114D1W3												
	UELPL210-115D1W3	2 3/16	8 1/8	6 1/4	2 3/8	25/32	29/32	13/16	4 13/32	2 9/16	2.469	0.969	5/8
	UELPL210-200D1W3												

Notes (1) These numbers indicate relubricatable type. If maintenance free type is needed, please order without suffix "D1".

(2) UELPL204 and UELPL205 has solid bases.

(3) UELPL208 has the same dimension as UELP208 shown in page B148.

Remarks Please refer to page A21 for size of grease fitting.

Bearing number	Housing number	Mass of unit
		kg lb
UEL204D1W3	PL204D1	0.8
UEL204-012D1W3	PL204D1	1.8
UEL205D1W3	PL205D1	0.9
UEL205-013D1W3	PL205D1	2.0
UEL205-014D1W3	PL205D1	
UEL205-015D1W3	PL205D1	
UEL205-100D1W3	PL205D1	
UEL206D1W3	PL206D1	1.4
UEL206-101D1W3	PL206D1	3.1
UEL206-102D1W3	PL206D1	
UEL206-103D1W3	PL206D1	
UEL206-104D1W3	PL206D1	
UEL207D1W3	PL207D1	1.7
UEL207-104D1W3	PL207D1	3.7
UEL207-105D1W3	PL207D1	
UEL207-106D1W3	PL207D1	
UEL207-107D1W3	PL207D1	
UEL209D1W3	PL209D1	2.3
UEL209-110D1W3	PL209D1	5.1
UEL209-111D1W3	PL209D1	
UEL209-112D1W3	PL209D1	
UEL210D1W3	PL210D1	3.0
UEL210-113D1W3	PL210D1	6.6
UEL210-114D1W3	PL210D1	
UEL210-115D1W3	PL210D1	
UEL210-200D1W3	PL210D1	

## Pillow block unit, cast housing low center height Eccentric locking collar type

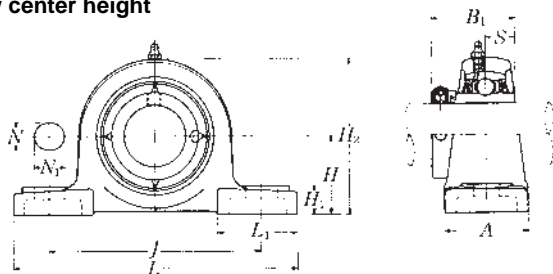

Shaft dia. mm inch	Unit number <sup>(1)</sup>	Nominal dimensions											Bolt size mm inch
		mm inch											
		H	L	J	A	N	N <sub>1</sub>	H <sub>1</sub>	H <sub>2</sub>	L <sub>1</sub>	B <sub>1</sub>	S	
55	<b>UELPL211D1W3</b>	61.91	219	171	60	20	23	23	124	65	71.4	27.75	M16
2	<b>UELPL211-200D1W3</b>												
2 <sup>1</sup> / <sub>16</sub>	<b>UELPL211-201D1W3</b>	2 <sup>7</sup> / <sub>16</sub>	8 <sup>5</sup> / <sub>8</sub>	6 <sup>23</sup> / <sub>32</sub>	2 <sup>3</sup> / <sub>8</sub>	25 <sup>1</sup> / <sub>32</sub>	29 <sup>1</sup> / <sub>32</sub>	29 <sup>1</sup> / <sub>32</sub>	4 <sup>7</sup> / <sub>8</sub>	2 <sup>9</sup> / <sub>16</sub>	2.811	1.093	5 <sup>1</sup> / <sub>8</sub>
2 <sup>1</sup> / <sub>8</sub>	<b>UELPL211-202D1W3</b>												
2 <sup>3</sup> / <sub>16</sub>	<b>UELPL211-203D1W3</b>												
60	<b>UELPL212D1W3</b>	68.26	241	184	70	20	23	25	136	70	77.8	30.95	M16
2 <sup>1</sup> / <sub>4</sub>	<b>UELPL212-204D1W3</b>												
2 <sup>5</sup> / <sub>16</sub>	<b>UELPL212-205D1W3</b>	2 <sup>11</sup> / <sub>16</sub>	9 <sup>1</sup> / <sub>2</sub>	7 <sup>1</sup> / <sub>4</sub>	2 <sup>3</sup> / <sub>4</sub>	25 <sup>1</sup> / <sub>32</sub>	29 <sup>1</sup> / <sub>32</sub>	3 <sup>1</sup> / <sub>32</sub>	5 <sup>11</sup> / <sub>32</sub>	2 <sup>3</sup> / <sub>4</sub>	3.063	1.219	5 <sup>1</sup> / <sub>8</sub>
2 <sup>3</sup> / <sub>8</sub>	<b>UELPL212-206D1W3</b>												
2 <sup>7</sup> / <sub>16</sub>	<b>UELPL212-207D1W3</b>												

Note <sup>(1)</sup> These numbers indicate relubricatable type. If maintenance free type is needed, please order without suffix "D1".

Remarks Please refer to page A21 for size of grease fitting.

Bearing number	Housing number	Mass of unit
		kg lb
UEL211D1W3	PL211D1	3.7
UEL211-200D1W3	PL211D1	8.2
UEL211-201D1W3	PL211D1	
UEL211-202D1W3	PL211D1	
UEL211-203D1W3	PL211D1	
UEL212D1W3	PL212D1	5.0
UEL212-204D1W3	PL212D1	11
UEL212-205D1W3	PL212D1	
UEL212-206D1W3	PL212D1	
UEL212-207D1W3	PL212D1	



## Pillow block unit, cast housing high center height Eccentric locking collar type

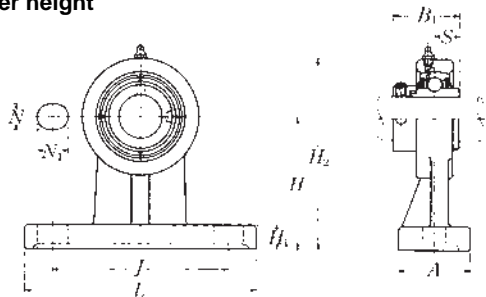

Shaft dia.  mm inch	Unit number (1)	Nominal dimensions										Bolt size  mm inch
		mm inch										
		<i>H</i>	<i>L</i>	<i>J</i>	<i>A</i>	<i>N</i>	<i>N</i> <sub>1</sub>	<i>H</i> <sub>1</sub>	<i>H</i> <sub>2</sub>	<i>B</i> <sub>1</sub>	<i>S</i>	
20  3/4	UELHP204D1W3	70	127	95	40	13	19	13	101	43.7	17.1	M10
	UELHP204-012D1W3	2 3/4	5	3 3/4	1 9/16	1/2	3/4	1/2	3 31/32	1.720	0.673	3/8
25  13/16 7/8 15/16 1	UELHP205D1W3	80	142	105	50	13	19	13	114	44.4	17.45	M10
	UELHP205-013D1W3											
	UELHP205-014D1W3	3 5/32	5 19/32	4 1/8	1 31/32	1/2	3/4	1/2	4 1/2	1.748	0.687	3/8
	UELHP205-015D1W3											
1  30  1 1/16 1 1/8 1 1/16 1 1/4	UELHP206D1W3	90	165	120	50	17	21	16	130	48.4	18.25	M14
	UELHP206-101D1W3											
	UELHP206-102D1W3	3 35/64	6 1/2	4 23/32	1 31/32	2 1/32	1 3/16	5/8	5 1/8	1.906	0.719	1/2
	UELHP206-103D1W3											
	UELHP206-104D1W3											
35  1 1/4 1 5/16 1 3/8 1 7/16	UELHP207D1W3	95	166	127	60	17	21	18	140	51.1	18.8	M14
	UELHP207-104D1W3											
	UELHP207-105D1W3	3 47/64	6 17/32	5	2 3/8	2 1/32	1 3/16	23/32	5 1/2	2.012	0.740	1/2
	UELHP207-106D1W3											
	UELHP207-107D1W3											
40  1 1/2 1 9/16	UELHP208D1W3	100	184	136	70	17	21	20	150	56.3	21.4	M14
	UELHP208-108D1W3	3 15/16	7 1/4	5 11/32	2 3/4	2 1/32	1 3/16	25/32	5 29/32	2.217	0.843	1/2
	UELHP208-109D1W3											
45  1 5/8 1 11/16 1 3/4	UELHP209D1W3	105	190	146	70	17	22	20	158	56.3	21.4	M14
	UELHP209-110D1W3											
	UELHP209-111D1W3	4 9/64	7 5/32	5 3/4	2 3/4	2 1/32	7/8	25/32	6 7/32	2.217	0.843	1/2
	UELHP209-112D1W3											
50  1 13/16 1 7/8 1 5/8 2	UELHP210D1W3	110	206	159	70	20	22	22	165	62.7	24.6	M16
	UELHP210-113D1W3											
	UELHP210-114D1W3	4 21/64	8 1/8	6 1/4	2 3/4	25/32	7/8	7/8	6 1/2	2.469	0.969	5/8
	UELHP210-115D1W3											
2	UELHP210-200D1W3											

Note (1) These numbers indicate relubricatable type. If maintenance free type is needed, please order without suffix "D1".

Remarks Please refer to page A21 for size of grease fitting.

Bearing number	Housing number	Mass of unit
		kg lb
UEL204D1W3	HP204D1	0.9
UEL204-012D1W3	HP204D1	2.0
UEL205D1W3	HP205D1	1.3
UEL205-013D1W3	HP205D1	2.9
UEL205-014D1W3	HP205D1	
UEL205-015D1W3	HP205D1	
UEL205-100D1W3	HP205D1	
UEL206D1W3	HP206D1	1.9
UEL206-101D1W3	HP206D1	4.2
UEL206-102D1W3	HP206D1	
UEL206-103D1W3	HP206D1	
UEL206-104D1W3	HP206D1	
UEL207D1W3	HP207D1	2.4
UEL207-104D1W3	HP207D1	5.3
UEL207-105D1W3	HP207D1	
UEL207-106D1W3	HP207D1	
UEL207-107D1W3	HP207D1	
UEL208D1W3	HP208D1	3.3
UEL208-108D1W3	HP208D1	7.3
UEL208-109D1W3	HP208D1	
UEL209D1W3	HP209D1	3.7
UEL209-110D1W3	HP209D1	8.2
UEL209-111D1W3	HP209D1	
UEL209-112D1W3	HP209D1	
UEL210D1W3	HP210D1	4.1
UEL210-113D1W3	HP210D1	9.0
UEL210-114D1W3	HP210D1	
UEL210-115D1W3	HP210D1	
UEL210-200D1W3	HP210D1	

## Narrow pillow block unit, cast housing Eccentric locking collar type

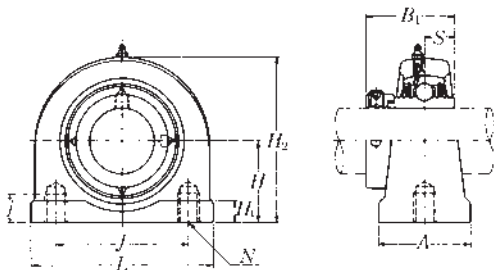

Shaft dia.  mm inch	Unit number (1)	Nominal dimensions									
		mm inch									
		<i>H</i>	<i>L</i>	<i>J</i>	<i>A</i>	<i>j</i>	<i>H</i> <sub>1</sub>	<i>H</i> <sub>2</sub>	<i>B</i> <sub>1</sub>	<i>S</i>	<i>N</i>
20  3/4	UELUP204D1W3	30.2	76	52	38	13	11	62	43.7	17.1	M10×1.5
	UELUP204-012D1W3	1 3/16	3	2 1/16	1 1/2	1/2	7/16	2 7/16	1.720	0.673	M10×1.5
25  13/16 7/8 15/16	UELUP205D1W3	36.5	84	56	38	15	12	72	44.4	17.45	M10×1.5
	UELUP205-013D1W3										
	UELUP205-014D1W3	1 7/16	3 5/16	2 7/32	1 1/2	19/32	15/32	2 27/32	1.748	0.687	M10×1.5
	UELUP205-015D1W3										
1	UELUP205-100D1W3										
30  1 1/16 1 1/8 1 7/16 1 1/4	UELUP206D1W3	42.9	94	66	48	18	12	84	48.4	18.25	M14×2
	UELUP206-101D1W3										
	UELUP206-102D1W3	1 11/16	3 11/16	2 19/32	1 7/8	29/32	15/32	3 5/16	1.906	0.719	M14×2
	UELUP206-103D1W3										
	UELUP206-104D1W3										
35  1 1/4 1 5/16 1 3/8 1 7/16	UELUP207D1W3	47.6	110	80	48	20	13	95	51.1	18.8	M14×2
	UELUP207-104D1W3										
	UELUP207-105D1W3	1 7/8	4 11/32	3 5/32	1 7/8	25/32	1/2	3 3/4	2.012	0.740	M14×2
	UELUP207-106D1W3										
	UELUP207-107D1W3										
40  1 1/2 1 9/16	UELUP208D1W3	49.2	116	84	54	20	13	100	56.3	21.4	M14×2
	UELUP208-108D1W3	1 15/16	4 9/16	3 5/16	2 1/8	25/32	1/2	3 15/16	2.217	0.843	M14×2
	UELUP208-109D1W3										
45  1 5/8 1 11/16 1 3/4	UELUP209D1W3	54.2	120	90	54	25	13	108	56.3	21.4	M14×2
	UELUP209-110D1W3										
	UELUP209-111D1W3	2 9/64	4 23/32	3 17/32	2 1/8	31/32	1/2	4 1/4	2.217	0.843	M14×2
	UELUP209-112D1W3										
50  1 3/16 1 7/8 1 5/16 2	UELUP210D1W3	57.2	130	94	60	25	14	116	62.7	24.6	M16×2
	UELUP210-113D1W3										
	UELUP210-114D1W3	2 1/4	5 1/8	3 11/16	2 3/8	31/32	9/16	4 9/16	2.469	0.969	M16×2
	UELUP210-115D1W3										
2	UELUP210-200D1W3										

Note (1) These numbers indicate relubricatable type. If maintenance free type is needed, please order without suffix "D1".

Remarks Please refer to page A21 for size of grease fitting.

Bearing number	Housing number	Mass of unit
		kg lb
UEL204D1W3	UP204D1	0.6
UEL204-012D1W3	UP204D1	1.3
UEL205D1W3	UP205D1	0.8
UEL205-013D1W3	UP205D1	1.8
UEL205-014D1W3	UP205D1	
UEL205-015D1W3	UP205D1	
UEL205-100D1W3	UP205D1	
UEL206D1W3	UP206D1	1.3
UEL206-101D1W3	UP206D1	2.9
UEL206-102D1W3	UP206D1	
UEL206-103D1W3	UP206D1	
UEL206-104D1W3	UP206D1	
UEL207D1W3	UP207D1	1.7
UEL207-104D1W3	UP207D1	3.7
UEL207-105D1W3	UP207D1	
UEL207-106D1W3	UP207D1	
UEL207-107D1W3	UP207D1	
UEL208D1W3	UP208D1	2.0
UEL208-108D1W3	UP208D1	4.4
UEL208-109D1W3	UP208D1	
UEL209D1W3	UP209D1	2.3
UEL209-110D1W3	UP209D1	5.1
UEL209-111D1W3	UP209D1	
UEL209-112D1W3	UP209D1	
UEL210D1W3	UP210D1	2.8
UEL210-113D1W3	UP210D1	6.2
UEL210-114D1W3	UP210D1	
UEL210-115D1W3	UP210D1	
UEL210-200D1W3	UP210D1	

## Pillow block unit, cast housing low center height Eccentric locking collar type

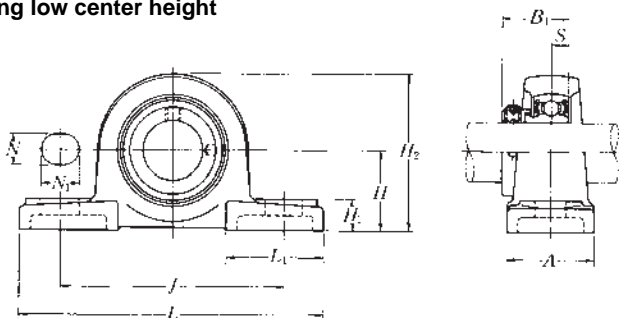

Shaft dia. mm inch	Unit number <sup>(1)</sup> ( <sup>2</sup> )	Nominal dimensions											Bolt size mm inch
		mm inch											
		H	L	J	A	N	N <sub>1</sub>	H <sub>1</sub>	H <sub>2</sub>	L <sub>1</sub>	B <sub>1</sub>	S	
12 1/2	<b>AELPL201W3</b>	26.99	121	89	35	11	14	13	54	40	28.6	6.5	M10
	<b>AELPL201-008W3</b>	1 1/16	4 3/4	3 1/2	1 3/8	7/16	9/16	1/2	2 1/8	1 9/16	1.126	0.256	3/8
15 9/16 5/8	<b>AELPL202W3</b>	26.99	121	89	35	11	14	13	54	40	28.6	6.5	M10
	<b>AELPL202-009W3</b> <b>AELPL202-010W3</b>	1 1/16	4 3/4	3 1/2	1 3/8	7/16	9/16	1/2	2 1/8	1 9/16	1.126	0.256	3/8
17 11/16	<b>AELPL203W3</b>	26.99	121	89	35	11	14	13	54	40	28.6	6.5	M10
	<b>AELPL203-011W3</b>	1 1/16	4 3/4	3 1/2	1 3/8	7/16	9/16	1/2	2 1/8	1 9/16	1.126	0.256	3/8
20 3/4	<b>AELPL204W3</b>	31.75	127	95	38	13	16	14	64	42	31	7.5	M10
	<b>AELPL204-012W3</b>	1 1/4	5	3 3/4	1 1/2	1/2	5/8	9/16	2 17/32	1 21/32	1.220	0.295	3/8
25 13/16 7/8 15/16 1	<b>AELPL205W3</b>	33.34	140	105	38	13	16	15	68	42	31	7.5	M10
	<b>AELPL205-013W3</b>												
	<b>AELPL205-014W3</b>	1 5/16	5 1/2	4 1/8	1 1/2	1/2	5/8	19/32	2 1/16	1 21/32	1.220	0.295	3/8
	<b>AELPL205-015W3</b> <b>AELPL205-100W3</b>												
30 1 1/16 1 1/8 1 3/16 1 1/4	<b>AELPL206W3</b>	39.69	165	121	48	17	20	17	80	54	35.7	9	M14
	<b>AELPL206-101W3</b>												
	<b>AELPL206-102W3</b>	1 9/16	6 1/2	4 3/4	1 7/8	21/32	25/32	21/32	3 5/32	2 1/8	1.406	0.354	1/2
	<b>AELPL206-103W3</b> <b>AELPL206-104W3</b>												
35 1 1/4 1 5/16 1 3/8 1 7/16	<b>AELPL207W3</b>	46.04	167	127	48	17	20	18	91	54	38.9	9.5	M14
	<b>AELPL207-104W3</b>												
	<b>AELPL207-105W3</b>	1 13/16	6 9/16	5	1 7/8	21/32	25/32	23/32	3 19/32	2 1/8	1.531	0.374	1/2
	<b>AELPL207-106W3</b> <b>AELPL207-107W3</b>												

Notes <sup>(1)</sup> AELPL201 to AELPL205 has solid base.

<sup>(2)</sup> If relubricatable type is needed, please order with suffix "D1".

Bearing number	Housing number	Mass of unit
		kg lb
AEL201W3 AEL201-008W3	PL201 PL201	0.5 1.1
AEL202W3 AEL202-009W3 AEL202-010W3	PL201 PL201 PL201	0.5 1.1
AEL203W3 AEL203-011W3	PL201 PL201	0.5 1.1
AEL204W3 AEL204-012W3	PL204 PL204	0.7 1.5
AEL205W3 AEL205-013W3 AEL205-014W3 AEL205-015W3 AEL205-100W3	PL205 PL205 PL205 PL205 PL205	0.8 1.8
AEL206W3 AEL206-101W3 AEL206-102W3 AEL206-103W3 AEL206-104W3	PL206 PL206 PL206 PL206 PL206	1.3 2.9
AEL207W3 AEL207-104W3 AEL207-105W3 AEL207-106W3 AEL207-107W3	PL207 PL207 PL207 PL207 PL207	1.6 3.5

## Pillow block unit, cast housing low center height Eccentric locking collar type

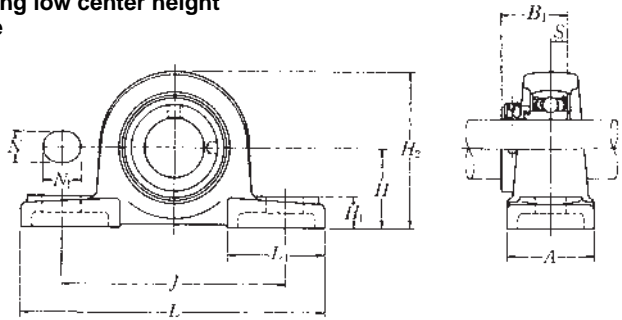

Shaft dia. mm inch	Unit number <sup>(1)</sup> ( <sup>2</sup> )	Nominal dimensions											Bolt size mm inch
		mm inch											
		H	L	J	A	N	N <sub>1</sub>	H <sub>1</sub>	H <sub>2</sub>	L <sub>1</sub>	B <sub>1</sub>	S	
12 ½	JELPL201W3	26.99	121	89	35	11	14	13	54	40	28.6	6.5	M10
	JELPL201-008W3	1 ⅛	4 ¾	3 ½	1 ⅜	⅞	⅝	½	2 ⅛	1 ⅞	1.126	0.256	⅜
15 9/16 5/8	JELPL202W3	26.99	121	89	35	11	14	13	54	40	28.6	6.5	M10
	JELPL202-009W3 JELPL202-010W3	1 ⅛	4 ¾	3 ½	1 ⅜	⅞	⅝	½	2 ⅛	1 ⅞	1.126	0.256	⅜
17 1 1/16	JELPL203W3	26.99	121	89	35	11	14	13	54	40	28.6	6.5	M10
	JELPL203-011W3	1 ⅛	4 ¾	3 ½	1 ⅜	⅞	⅝	½	2 ⅛	1 ⅞	1.126	0.256	⅜
20 ¾	JELPL204W3	31.75	127	95	38	13	16	14	64	42	31	7.5	M10
	JELPL204-012W3	1 ¼	5	3 ¾	1 ½	½	⅝	⅞	2 17/32	1 21/32	1.220	0.295	⅜
25 1 13/16 7/8 15/16 1	JELPL205W3	33.34	140	105	38	13	16	15	68	42	31	7.5	M10
	JELPL205-013W3												
	JELPL205-014W3 JELPL205-015W3	1 5/16	5 ½	4 ⅞	1 ½	½	⅝	19/32	2 1/16	1 21/32	1.220	0.295	⅜
	JELPL205-100W3												
30 1 1/16 1 1/8 1 3/16 1 ¼	JELPL206W3	39.69	165	121	48	17	20	17	80	54	35.7	9	M14
	JELPL206-101W3												
	JELPL206-102W3 JELPL206-103W3 JELPL206-104W3	1 9/16	6 ½	4 ¾	1 7/8	2 1/32	25/32	2 1/32	3 5/32	2 ⅛	1.406	0.354	½
35 1 ¼ 1 5/16 1 3/8 1 7/16	JELPL207W3	46.04	167	127	48	17	20	18	91	54	38.9	9.5	M14
	JELPL207-104W3												
	JELPL207-105W3 JELPL207-106W3 JELPL207-107W3	1 13/16	6 9/16	5	1 7/8	2 1/32	25/32	23/32	3 19/32	2 ⅛	1.531	0.374	½

Notes <sup>(1)</sup> JELPL201 to JELPL205 have solid bases.

<sup>(2)</sup> If relubricatable type is needed, please order with suffix "D1".

Bearing number	Housing number	Mass of unit
		kg lb
JEL201W3 JEL201-008W3	PL201 PL201	0.5 1.1
JEL202W3 JEL202-009W3 JEL202-010W3	PL201 PL201 PL201	0.5 1.1
JEL203W3 JEL203-011W3	PL201 PL201	0.5 1.1
JEL204W3 JEL204-012W3	PL204 PL204	0.7 1.5
JEL205W3 JEL205-013W3 JEL205-014W3 JEL205-015W3 JEL205-100W3	PL205 PL205 PL205 PL205 PL205	0.8 1.8
JEL206W3 JEL206-101W3 JEL206-102W3 JEL206-103W3 JEL206-104W3	PL206 PL206 PL206 PL206 PL206	1.3 2.9
JEL207W3 JEL207-104W3 JEL207-105W3 JEL207-106W3 JEL207-107W3	PL207 PL207 PL207 PL207 PL207	1.6 3.5



## Pillow block unit, pressed steel housing Eccentric locking collar type

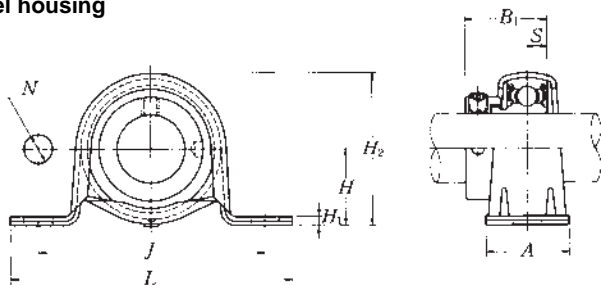

Shaft dia. mm inch	Unit number	Nominal dimensions									Bolt size mm inch
		mm inch									
		<i>H</i>	<i>L</i>	<i>J</i>	<i>A</i>	<i>N</i>	<i>H</i> <sub>1</sub>	<i>H</i> <sub>2</sub>	<i>B</i> <sub>1</sub>	<i>S</i>	
12 1/2	<b>AELPP201W3</b>	22.2	86	68	25	9.5	3.2	43.8	28.6	6.5	M8
	<b>AELPP201-008W3</b>	7/8	3 3/8	2 11/16	31/32	3/8	0.126	1 23/32	1.126	0.256	5/16
15 9/16 5/8	<b>AELPP202W3</b>	22.2	86	68	25	9.5	3.2	43.8	28.6	6.5	M8
	<b>AELPP202-009W3</b> <b>AELPP202-010W3</b>	7/8	3 3/8	2 11/16	31/32	3/8	0.126	1 23/32	1.126	0.256	5/16
17 1 1/16	<b>AELPP203W3</b>	22.2	86	68	25	9.5	3.2	43.8	28.6	6.5	M8
	<b>AELPP203-011W3</b>	7/8	3 3/8	2 11/16	31/32	3/8	0.126	1 23/32	1.126	0.256	5/16
20 3/4	<b>AELPP204W3</b>	25.4	98	76	32	9.5	3.2	50.5	31	7.5	M8
	<b>AELPP204-012W3</b>	1	3 27/32	3	1 1/4	3/8	0.126	2	1.220	0.295	5/16
25 13/16 7/8 15/16 1	<b>AELPP205W3</b>	28.6	108	86	32	11.5	4	56.6	31	7.5	M10
	<b>AELPP205-013W3</b>										
	<b>AELPP205-014W3</b> <b>AELPP205-015W3</b>	1 1/8	4 1/4	3 3/8	1 1/4	29/64	0.157	2 7/32	1.220	0.295	3/8
	<b>AELPP205-100W3</b>										
30 1 1/16 1 1/8 1 3/16 1 1/4	<b>AELPP206W3</b>	33.3	117	95	38	11.5	4	66.3	35.7	9	M10
	<b>AELPP206-101W3</b>										
	<b>AELPP206-102W3</b> <b>AELPP206-103W3</b>	1 5/16	4 19/32	3 3/4	1 1/2	29/64	0.157	2 5/8	1.406	0.354	3/8
	<b>AELPP206-104W3</b>										
35 1 1/4 1 5/16 1 3/8 1 1/16	<b>AELPP207W3</b>	39.7	129	106	42	11.5	4.6	78	38.9	9.5	M10
	<b>AELPP207-104W3</b>										
	<b>AELPP207-105W3</b> <b>AELPP207-106W3</b>	1 9/16	5 3/32	4 3/16	1 21/32	29/64	0.181	3 1/16	1.531	0.374	3/8
	<b>AELPP207-107W3</b>										

Note (1) The permissible load only applies in applications where the load is stable and the speed is 2400 min<sup>-1</sup> or less.  
The mounting surface should be flat.

<b>Max. load (1)</b>		<b>Bearing number</b>	<b>Housing number</b>	<b>Mass of unit</b>	
<b>recommended</b>				<b>kg</b>	<b>lb</b>
<b>N lbf</b>					
radial	axial				
2 000	800	AEL201W3	PP203	0.2	
440	160	AEL201-008W3	PP203	0.4	
2 000	800	AEL202W3	PP203	0.2	
440	160	AEL202-009W3	PP203	0.4	
		AEL202-010W3	PP203		
2 000	800	AEL203W3	PP203	0.2	
440	160	AEL203-011W3	PP203	0.4	
2 500	1 000	AEL204W3	PP204	0.3	
550	200	AEL204-012W3	PP204	0.7	
3 500	1 400	AEL205W3	PP205	0.3	
		AEL205-013W3	PP205		
770	280	AEL205-014W3	PP205	0.7	
		AEL205-015W3	PP205		
		AEL205-100W3	PP205		
4 000	1 600	AEL206W3	PP206	0.5	
		AEL206-101W3	PP206		
880	320	AEL206-102W3	PP206	1.1	
		AEL206-103W3	PP206		
		AEL206-104W3	PP206		
4 500	1 800	AEL207W3	PP207	0.8	
		AEL207-104W3	PP207		
990	360	AEL207-105W3	PP207	1.8	
		AEL207-106W3	PP207		
		AEL207-107W3	PP207		

## Pillow block unit, pressed steel housing with rubber ring Eccentric locking collar type

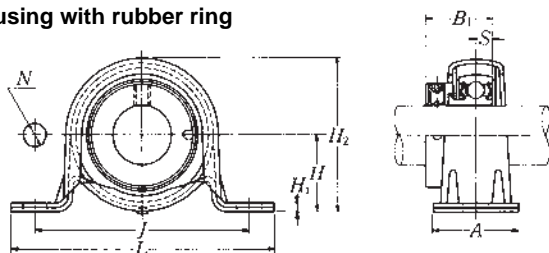

Shaft dia. mm inch	Unit number	Nominal dimensions									Bolt size mm inch
		mm inch									
		<i>H</i>	<i>L</i>	<i>J</i>	<i>A</i>	<i>N</i>	<i>H</i> <sub>1</sub>	<i>H</i> <sub>2</sub>	<i>B</i> <sub>1</sub>	<i>S</i>	
12 1/2	<b>AELRPP201W3</b>	25.4	98	76	32	9.5	3.2	50.5	28.6	6.5	M8
	<b>AELRPP201-008W3</b>	1	3 <sup>27</sup> / <sub>32</sub>	3	1 <sup>1</sup> / <sub>4</sub>	<sup>3</sup> / <sub>8</sub>	0.126	2	1.126	0.256	<sup>5</sup> / <sub>16</sub>
15 9/16 5/8	<b>AELRPP202W3</b>	25.4	98	76	32	9.5	3.2	50.5	28.6	6.5	M8
	<b>AELRPP202-009W3</b> <b>AELRPP202-010W3</b>	1	3 <sup>27</sup> / <sub>32</sub>	3	1 <sup>1</sup> / <sub>4</sub>	<sup>3</sup> / <sub>8</sub>	0.126	2	1.126	0.256	<sup>5</sup> / <sub>16</sub>
17 11/16	<b>AELRPP203W3</b>	25.4	98	76	32	9.5	3.2	50.5	28.6	6.5	M8
	<b>AELRPP203-011W3</b>	1	3 <sup>27</sup> / <sub>32</sub>	3	1 <sup>1</sup> / <sub>4</sub>	<sup>3</sup> / <sub>8</sub>	0.126	2	1.126	0.256	<sup>5</sup> / <sub>16</sub>
20 3/4	<b>AELRPP204W3</b>	28.6	108	86	32	11.5	4	56.6	31	7.5	M10
	<b>AELRPP204-012W3</b>	1 <sup>1</sup> / <sub>8</sub>	4 <sup>1</sup> / <sub>4</sub>	3 <sup>3</sup> / <sub>8</sub>	1 <sup>1</sup> / <sub>4</sub>	<sup>29</sup> / <sub>64</sub>	0.157	2 <sup>7</sup> / <sub>32</sub>	1.220	0.295	<sup>3</sup> / <sub>8</sub>
25 13/16 7/8 15/16 1	<b>AELRPP205W3</b>	33.3	117	95	38	11.5	4	66.3	31	7.5	M10
	<b>AELRPP205-013W3</b>										
	<b>AELRPP205-014W3</b>	1 <sup>5</sup> / <sub>16</sub>	4 <sup>19</sup> / <sub>32</sub>	3 <sup>3</sup> / <sub>4</sub>	1 <sup>1</sup> / <sub>2</sub>	<sup>29</sup> / <sub>64</sub>	0.157	2 <sup>5</sup> / <sub>8</sub>	1.220	0.295	<sup>3</sup> / <sub>8</sub>
	<b>AELRPP205-015W3</b> <b>AELRPP205-100W3</b>										
30 1 1/16 1 1/8 1 3/16 1 1/4	<b>AELRPP206W3</b>	39.7	129	106	42	11.5	4.6	78	35.7	9	M10
	<b>AELRPP206-101W3</b>										
	<b>AELRPP206-102W3</b>	1 <sup>9</sup> / <sub>16</sub>	5 <sup>3</sup> / <sub>32</sub>	4 <sup>3</sup> / <sub>16</sub>	1 <sup>21</sup> / <sub>32</sub>	<sup>29</sup> / <sub>64</sub>	0.181	3 <sup>1</sup> / <sub>16</sub>	1.406	0.354	<sup>3</sup> / <sub>8</sub>
	<b>AELRPP206-103W3</b> <b>AELRPP206-104W3</b>										

**Note** (1) The permissible load only applies in applications where the load is stable and the speed is 2400 min<sup>-1</sup> or less. The mounting surface should be flat.

**Remarks** When an anti-vibration rubber ring is used, the self alignment capability will be reduce.

Max. load (1) recommended		Bearing number	Housing number		Mass of unit
			rubber ring	steel	
N lbf					kg lb
radial	axial				
1 000	200	AEL201W3	R201	PP204	0.2
220	40	AEL201-008W3	R201	PP204	0.4
1 000	200	AEL202W3	R202	PP204	0.2
220	40	AEL202-009W3	R202	PP204	0.4
		AEL202-010W3	R202	PP204	
1 000	200	AEL203W3	R203	PP204	0.2
220	40	AEL203-011W3	R203	PP204	0.4
1 150	200	AEL204W3	R204	PP205	0.3
250	40	AEL204-012W3	R204	PP205	0.7
1 300	200	AEL205W3	R205	PP206	0.4
		AEL205-013W3	R205	PP206	
280	40	AEL205-014W3	R205	PP206	0.9
		AEL205-015W3	R205	PP206	
		AEL205-100W3	R205	PP206	
1 500	200	AEL206W3	R206	PP207	0.6
		AEL206-101W3	R206	PP207	
330	40	AEL206-102W3	R206	PP207	1.3
		AEL206-103W3	R206	PP207	
		AEL206-104W3	R206	PP207	

## Square flanged unit, cast housing Eccentric locking collar type

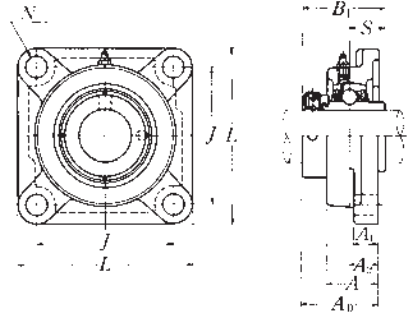

Shaft dia. mm inch	Unit number (1)	Nominal dimensions										Bolt size mm inch
		mm inch										
		L	J	A <sub>2</sub>	A <sub>1</sub>	A	N	A <sub>0</sub>	B <sub>1</sub>	S	F min.	
20 3/4	UELF204D1W3	86	64	15	11	25.5	12	41.6	43.7	17.1	34	M10
	UELF204-012D1W3	3 3/8	2 33/64	19/32	7/16	1	15/32	1 41/64	1.720	0.673	1.339	3/8
25 13/16 7/8 15/16 1	UELF205D1W3	95	70	16	13	27	12	42.95	44.4	17.45	38	M10
	UELF205-013D1W3											
	UELF205-014D1W3	3 3/4	2 3/4	5/8	1/2	1 1/16	15/32	1 11/16	1.748	0.687	1.496	3/8
	UELF205-015D1W3											
30 1 1/16 1 1/8 1 7/16 1 1/4	UELF206D1W3	108	83	18	13	31	12	48.15	48.4	18.25	45	M10
	UELF206-101D1W3											
	UELF206-102D1W3	4 1/4	3 17/64	45/64	1/2	1 7/32	15/32	1 57/64	1.906	0.719	1.772	3/8
	UELF206-103D1W3											
	UELF206-104D1W3											
35 1 1/4 1 5/16 1 3/8 1 7/16	UELF207D1W3	117	92	19	15	34	14	51.3	51.1	18.8	51	M12
	UELF207-104D1W3											
	UELF207-105D1W3	4 19/32	3 5/8	3/4	19/32	1 11/32	35/64	2 1/64	2.012	0.740	2.008	7/16
	UELF207-106D1W3											
	UELF207-107D1W3											
40 1 1/2 1 9/16	UELF208D1W3	130	102	21	15	36	16	55.9	56.3	21.4	57	M14
	UELF208-108D1W3	5 1/8	4 1/64	53/64	19/32	1 13/32	5/8	2 13/64	2.217	0.843	2.244	1/2
	UELF208-109D1W3											
45 1 5/8 1 11/16 1 3/4	UELF209D1W3	137	105	22	16	38	16	56.9	56.3	21.4	62	M14
	UELF209-110D1W3											
	UELF209-111D1W3	5 13/32	4 3/64	55/64	5/8	1 1/2	5/8	2 15/64	2.217	0.843	2.441	1/2
	UELF209-112D1W3											
50 1 13/16 1 7/8 1 5/8 2	UELF210D1W3	143	111	22	16	40	16	60.1	62.7	24.6	67	M14
	UELF210-113D1W3											
	UELF210-114D1W3	5 5/8	4 3/8	55/64	5/8	1 9/16	5/8	2 23/64	2.469	0.969	2.638	1/2
	UELF210-115D1W3											
	UELF210-200D1W3											

Note (1) These numbers indicate relubricatable type. If maintenance free type is needed, please order without suffix "D1".

Remarks Please refer to page A21 for size of grease fitting

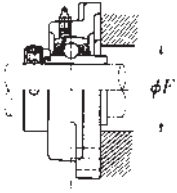

Bearing number	Housing number	Mass of unit	
		kg	lb
UEL204D1W3	F204D1	0.6	
UEL204-012D1W3	F204D1	1.3	
UEL205D1W3	F205D1	0.9	
UEL205-013D1W3	F205D1		
UEL205-014D1W3	F205D1	2.0	
UEL205-015D1W3	F205D1		
UEL205-100D1W3	F205D1		
UEL206D1W3	F206D1	1.2	
UEL206-101D1W3	F206D1		
UEL206-102D1W3	F206D1	2.6	
UEL206-103D1W3	F206D1		
UEL206-104D1W3	F206D1		
UEL207D1W3	F207D1	1.6	
UEL207-104D1W3	F207D1		
UEL207-105D1W3	F207D1	3.5	
UEL207-106D1W3	F207D1		
UEL207-107D1W3	F207D1		
UEL208D1W3	F208D1	1.9	
UEL208-108D1W3	F208D1	4.2	
UEL208-109D1W3	F208D1		
UEL209D1W3	F209D1	2.3	
UEL209-110D1W3	F209D1		
UEL209-111D1W3	F209D1	5.1	
UEL209-112D1W3	F209D1		
UEL210D1W3	F210D1	2.7	
UEL210-113D1W3	F210D1		
UEL210-114D1W3	F210D1	6.0	
UEL210-115D1W3	F210D1		
UEL210-200D1W3	F210D1		

## Square flanged unit, cast housing Eccentric locking collar type

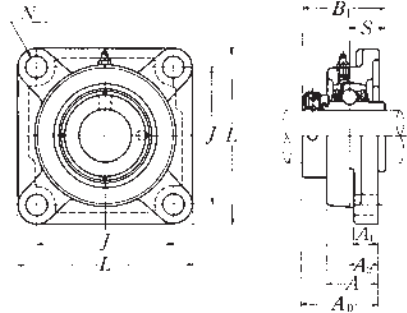

Shaft dia. mm inch	Unit number (1)	Nominal dimensions										Bolt size mm inch
		<i>L</i>	<i>J</i>	<i>A</i> <sub>2</sub>	<i>A</i> <sub>1</sub>	<i>A</i>	<i>N</i>	<i>A</i> <sub>0</sub>	<i>B</i> <sub>1</sub>	<i>S</i>	<i>F</i> <sub>min.</sub>	
55 2 2 1/16 2 1/8 2 3/16	<b>UELF211D1W3</b> <b>UELF211-200D1W3</b> <b>UELF211-201D1W3</b> <b>UELF211-202D1W3</b> <b>UELF211-203D1W3</b>	162 6 3/8	130 5 1/8	25 63/64	18 23/32	43 1 11/16	19 3/4	68.65 2 45/64	71.4	27.75	73	M16 5/8
60 2 1/4 2 5/16 2 3/8 2 7/16	<b>UELF212D1W3</b> <b>UELF212-204D1W3</b> <b>UELF212-205D1W3</b> <b>UELF212-206D1W3</b> <b>UELF212-207D1W3</b>	175 6 7/8	143 5 5/8	29 1 9/64	18 23/32	48 1 7/8	19 3/4	75.85 2 63/64	77.8	30.95	81	M16 5/8
65 2 1/2 2 5/16	<b>UELF213D1W3</b> <b>UELF213-208D1W3</b> <b>UELF213-209D1W3</b>	187 7 3/8	149 5 55/64	30 1 3/16	22 7/8	50 1 31/32	19 3/4	81.55 3 13/64	85.7	34.15	87	M16 5/8
70 2 5/8 2 11/16 2 3/4	<b>UELF214D1W3</b> <b>UELF214-210D1W3</b> <b>UELF214-211D1W3</b> <b>UELF214-212D1W3</b>	193 7 19/32	152 5 63/64	31 1 7/32	22 7/8	54 2 1/8	19 3/4	82.55 3 3/4	85.7	34.15	91	M16 5/8
75 2 13/16 2 7/8 2 5/16 3	<b>UELF215D1W3</b> <b>UELF215-213D1W3</b> <b>UELF215-214D1W3</b> <b>UELF215-215D1W3</b> <b>UELF215-300D1W3</b>	200 7 7/8	159 6 17/64	34 1 11/32	22 7/8	56 2 7/32	19 3/4	88.7 3 31/64	92	37.3	97	M16 5/8

Note (1) These numbers indicate relubricatable type. If maintenance free type is needed, please order without suffix "D1".

Remarks Please refer to page A21 for size of grease fitting.

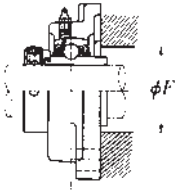

Bearing number	Housing number	Mass of unit
		kg lb
UEL211D1W3	F211D1	3.6
UEL211-200D1W3	F211D1	7.9
UEL211-201D1W3	F211D1	
UEL211-202D1W3	F211D1	
UEL211-203D1W3	F211D1	
UEL212D1W3	F212D1	4.2
UEL212-204D1W3	F212D1	9.3
UEL212-205D1W3	F212D1	
UEL212-206D1W3	F212D1	
UEL212-207D1W3	F212D1	
UEL213D1W3	F213D1	6.1
UEL213-208D1W3	F213D1	13
UEL213-209D1W3	F213D1	
UEL214D1W3	F214D1	6.6
UEL214-210D1W3	F214D1	15
UEL214-211D1W3	F214D1	
UEL214-212D1W3	F214D1	
UEL215D1W3	F215D1	6.9
UEL215-213D1W3	F215D1	15
UEL215-214D1W3	F215D1	
UEL215-215D1W3	F215D1	
UEL215-300D1W3	F215D1	



## Square flanged unit, cast housing Eccentric locking collar type

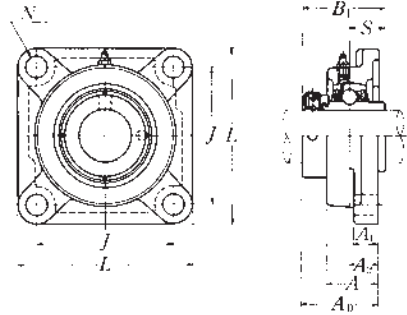

Shaft dia.  mm inch	Unit number <sup>(1)</sup> ( <sup>2</sup> )	Nominal dimensions										Bolt size  mm inch
		mm inch										
		L	J	A <sub>2</sub>	A <sub>1</sub>	A	N	A <sub>0</sub>	B <sub>1</sub>	S	F min.	
25  1 <sup>3</sup> / <sub>16</sub>  7 <sub>8</sub>  1 <sup>5</sup> / <sub>16</sub>  1	UELF305D1W3	110	80	16	13	29	16	46.1	46.8	16.7	41	M14    1/2
	UELF305-013D1W3	4 <sup>1</sup> / <sub>32</sub>	3 <sup>5</sup> / <sub>32</sub>	5 8	1 2	1 <sup>5</sup> / <sub>32</sub>	5 8	1 <sup>13</sup> / <sub>16</sub>	1.843	0.657	1.614	
	UELF305-014D1W3											
	UELF305-015D1W3											
	UELF305-100D1W3											
30  1 <sup>1</sup> / <sub>16</sub>  1 <sup>1</sup> / <sub>8</sub>  1 <sup>3</sup> / <sub>16</sub>	UELF306D1W3	125	95	18	15	32	16	50.5	50	17.5	49	M14    1/2
	UELF306-101D1W3	4 <sup>29</sup> / <sub>32</sub>	3 <sup>47</sup> / <sub>64</sub>	4 <sup>5</sup> / <sub>64</sub>	1 <sup>9</sup> / <sub>32</sub>	1 <sup>1</sup> / <sub>4</sub>	5 8	1 <sup>63</sup> / <sub>64</sub>	1.969	0.689	1.929	
	UELF306-102D1W3											
	UELF306-103D1W3											
35  1 <sup>1</sup> / <sub>4</sub>  1 <sup>5</sup> / <sub>16</sub>  1 <sup>3</sup> / <sub>8</sub>  1 <sup>7</sup> / <sub>16</sub>	UELF307D1W3	135	100	20	16	36	19	53.3	51.6	18.3	–	M16     5/8
	UELF307-104D1W3	5 <sup>5</sup> / <sub>16</sub>	3 <sup>15</sup> / <sub>16</sub>	2 <sup>5</sup> / <sub>32</sub>	5 8	1 <sup>13</sup> / <sub>32</sub>	3 4	2 <sup>3</sup> / <sub>32</sub>	2.031	0.720	–	
	UELF307-105D1W3											
	UELF307-106D1W3											
	UELF307-107D1W3											
40  1 <sup>1</sup> / <sub>2</sub>  1 <sup>7</sup> / <sub>16</sub>	UELF308D1W3	150	112	23	17	40	19	60.3	57.1	19.8	–	M16    5/8
	UELF308-108D1W3	5 <sup>29</sup> / <sub>32</sub>	4 <sup>13</sup> / <sub>32</sub>	2 <sup>9</sup> / <sub>32</sub>	2 <sup>1</sup> / <sub>32</sub>	1 <sup>9</sup> / <sub>16</sub>	3 4	2 <sup>3</sup> / <sub>8</sub>	2.248	0.780	–	
	UELF308-109D1W3											
45  1 <sup>5</sup> / <sub>8</sub>  1 <sup>1</sup> / <sub>16</sub>  1 <sup>3</sup> / <sub>4</sub>	UELF309D1W3	160	125	25	18	44	19	63.9	58.7	19.8	–	M16     5/8
	UELF309-110D1W3	6 <sup>5</sup> / <sub>16</sub>	4 <sup>59</sup> / <sub>64</sub>	6 <sup>3</sup> / <sub>64</sub>	2 <sup>3</sup> / <sub>32</sub>	1 <sup>23</sup> / <sub>32</sub>	3 4	2 <sup>33</sup> / <sub>64</sub>	2.311	0.780	–	
	UELF309-111D1W3											
	UELF309-112D1W3											
50  1 <sup>3</sup> / <sub>16</sub>  1 <sup>1</sup> / <sub>6</sub>  1 <sup>15</sup> / <sub>16</sub>	UELF310D1W3	175	132	28	19	48	23	70	66.6	24.6	–	M20     3/4
	UELF310-113D1W3	6 <sup>7</sup> / <sub>8</sub>	5 <sup>13</sup> / <sub>64</sub>	1 <sup>7</sup> / <sub>64</sub>	3 4	1 <sup>7</sup> / <sub>8</sub>	2 <sup>9</sup> / <sub>32</sub>	2 <sup>3</sup> / <sub>4</sub>	2.622	0.969	–	
	UELF310-114D1W3											
	UELF310-115D1W3											

Notes <sup>(1)</sup> These numbers indicate relubricatable type. If maintenance free type is needed, please order without suffix "D1".

<sup>(2)</sup> Inner race face does not protrude from the housing face except UELF305 and UELF316.

Remarks Please refer to page A21 for size of grease fitting

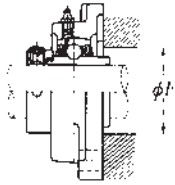

Bearing number	Housing number	Mass of unit
		kg lb
UEL305D1W3	F305D1	1.2
UEL305-013D1W3	F305D1	
UEL305-014D1W3	F305D1	2.6
UEL305-015D1W3	F305D1	
UEL305-100D1W3	F305D1	
UEL306D1W3	F306D1	1.8
UEL306-101D1W3	F306D1	
UEL306-102D1W3	F306D1	4.0
UEL306-103D1W3	F306D1	
UEL307D1W3	F307D1	2.2
UEL307-104D1W3	F307D1	
UEL307-105D1W3	F307D1	4.9
UEL307-106D1W3	F307D1	
UEL307-107D1W3	F307D1	
UEL308D1W3	F308D1	2.9
UEL308-108D1W3	F308D1	6.4
UEL308-109D1W3	F308D1	
UEL309D1W3	F309D1	3.6
UEL309-110D1W3	F309D1	
UEL309-111D1W3	F309D1	7.9
UEL309-112D1W3	F309D1	
UEL310D1W3	F310D1	4.6
UEL310-113D1W3	F310D1	
UEL310-114D1W3	F310D1	10
UEL310-115D1W3	F310D1	

## Square flanged unit, cast housing Eccentric locking collar type

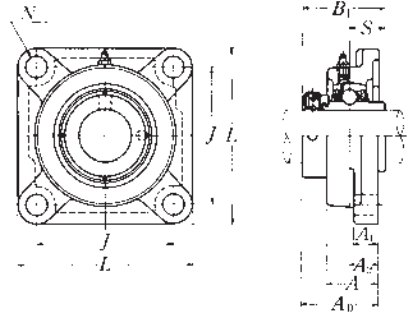

Shaft dia. mm inch	Unit number <sup>(1)</sup> ( <sup>2</sup> )	Nominal dimensions										Bolt size mm inch
		L	J	A <sub>2</sub>	A <sub>1</sub>	A	N	A <sub>0</sub>	B <sub>1</sub>	S	F min.	
55	<b>UELF311D1W3</b>	185	140	30	20	52	23	75.2	73	27.8	–	M20
2	<b>UELF311-200D1W3</b>											
2 1/16	<b>UELF311-201D1W3</b>											
2 1/8	<b>UELF311-202D1W3</b>	7 9/32	5 33/64	1 3/16	25/32	2 1/16	29/32	2 61/64	2.874	1.094	–	3/4
2 3/16	<b>UELF311-203D1W3</b>											
60	<b>UELF312D1W3</b>	195	150	33	22	56	23	81.45	79.4	30.95	–	M20
2 1/4	<b>UELF312-204D1W3</b>											
2 5/16	<b>UELF312-205D1W3</b>											
2 3/8	<b>UELF312-206D1W3</b>	7 1/16	5 29/32	1 19/64	7/8	2 7/32	29/32	3 13/64	3.126	1.219	–	3/4
2 7/16	<b>UELF312-207D1W3</b>											
65	<b>UELF313D1W3</b>	208	166	33	22	58	23	86.15	85.7	32.55	93	M20
2 1/2	<b>UELF313-208D1W3</b>											
2 5/16	<b>UELF313-209D1W3</b>	8 3/16	6 17/32	1 19/64	7/8	2 9/32	29/32	3 25/64	3.374	1.281	3.661	3/4
70	<b>UELF314D1W3</b>	226	178	36	25	61	25	93.95	92.1	34.15	–	M22
2 5/8	<b>UELF314-210D1W3</b>											
2 11/16	<b>UELF314-211D1W3</b>											
2 3/4	<b>UELF314-212D1W3</b>	8 29/32	6 1/64	1 27/64	31/32	2 13/32	63/64	3 45/64	3.626	1.344	–	7/8
75	<b>UELF315D1W3</b>	236	184	39	25	66	25	101.7	100	37.3	106	M22
2 3/8	<b>UELF315-213D1W3</b>											
2 7/8	<b>UELF315-214D1W3</b>											
2 5/16	<b>UELF315-215D1W3</b>	9 9/32	7 1/4	1 17/32	31/32	2 19/32	63/64	4	3.937	1.469	4.173	7/8
3	<b>UELF315-300D1W3</b>											
80	<b>UELF316D1W3</b>	250	196	38	27	68	31	103.9	106.4	40.5	112	M27
3 1/16	<b>UELF316-301D1W3</b>											
3 3/8	<b>UELF316-302D1W3</b>											
3 3/16	<b>UELF316-303D1W3</b>	9 27/32	7 29/32	1 1/2	1 1/16	2 11/16	1 7/32	4 3/32	4.189	1.594	4.409	1

Notes <sup>(1)</sup> These numbers indicate relubricatable type. If maintenance free type is needed, please order without suffix "D1".

<sup>(2)</sup> Inner race face does not protrude from the housing face except UELF305 and UELF316.

Remarks Please refer to page A21 for size of grease fitting

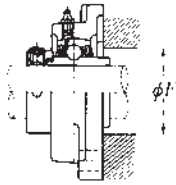

Bearing number	Housing number	Mass of unit
		kg lb
UEL311D1W3	F311D1	5.6
UEL311-200D1W3	F311D1	12
UEL311-201D1W3	F311D1	
UEL311-202D1W3	F311D1	
UEL311-203D1W3	F311D1	
UEL312D1W3	F312D1	
UEL312-204D1W3	F312D1	15
UEL312-205D1W3	F312D1	
UEL312-206D1W3	F312D1	
UEL312-207D1W3	F312D1	
UEL313D1W3	F313D1	
UEL313-208D1W3	F313D1	19
UEL313-209D1W3	F313D1	
UEL314D1W3	F314D1	10
UEL314-210D1W3	F314D1	22
UEL314-211D1W3	F314D1	
UEL314-212D1W3	F314D1	
UEL315D1W3	F315D1	12
UEL315-213D1W3	F315D1	26
UEL315-214D1W3	F315D1	
UEL315-215D1W3	F315D1	
UEL315-300D1W3	F315D1	
UEL316D1W3	F316D1	
UEL316-301D1W3	F316D1	33
UEL316-302D1W3	F316D1	
UEL316-303D1W3	F316D1	

# UELF3

## Square flanged unit, cast housing Eccentric locking collar type

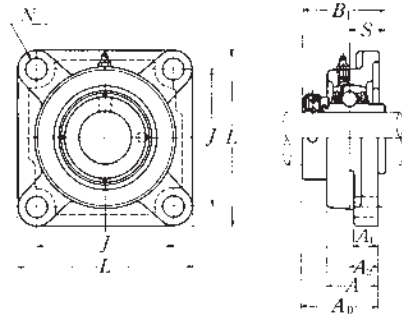

Shaft dia.  mm inch	Unit number <sup>(1)</sup> ( <sup>2</sup> )	Nominal dimensions										Bolt size  mm inch
		mm inch										
		L	J	A <sub>2</sub>	A <sub>1</sub>	A	N	A <sub>0</sub>	B <sub>1</sub>	S	F min.	
85 3 3/4 3 5/16 3 7/16	UELF317D1W3 UELF317-304D1W3 UELF317-305D1W3 UELF317-307D1W3	260 10 3/4	204 8 1/2	44 1 47/64	27 1 1/16	74 2 29/32	31 1 1/32	111.45 4 25/64	109.5 4.311	42.05 1.656	119 4.685	M27 1
90 3 7/16 3 1/2	UELF318D1W3 UELF318-307D1W3 UELF318-308D1W3	280 11 1/2	216 8 1/2	44 1 47/64	30 1 1/16	76 3	35 1 3/8	116.25 4 37/64	115.9 4.563	43.65 1.719	125 4.921	M30 1 1/8
95 3 5/8 3 11/16 3 3/4	UELF319D1W3 UELF319-310D1W3 UELF319-311D1W3 UELF319-312D1W3	290 11 13/32	228 8 31/32	59 2 21/64	30 1 3/16	94 3 11/16	35 1 3/8	142.4 5 39/64	122.3 4.815	38.9 1.531	– –	M30 1 1/8
100 3 3/8 3 7/8 3 15/16 4	UELF320D1W3 UELF320-313D1W3 UELF320-314D1W3 UELF320-315D1W3 UELF320-400D1W3	310 12 7/32	242 9 7/32	59 2 21/64	32 1 1/4	94 3 11/16	38 1 1/2	137.6 5 27/64	128.6 5.063	50 1.969	– –	M33 1 1/4
105	UELF321D1W3	310	242	59	32	94	38	150.3	139.7	48.4	–	M33
110	UELF322D1W3	340	266	60	35	96	41	152.1	141.3	49.2	–	M36

Notes <sup>(1)</sup> These numbers indicate relubricatable type. If maintenance free type is needed, please order without suffix "D1".

<sup>(2)</sup> Inner race face does not protrude from the housing face except UELF305 and UELF316.

Remarks Please refer to page A21 for size of grease fitting

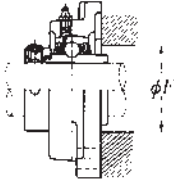

Bearing number	Housing number	Mass of unit
		kg lb
UEL317D1W3	F317D1	16
UEL317-304D1W3	F317D1	35
UEL317-305D1W3	F317D1	
UEL317-307D1W3	F317D1	
UEL318D1W3	F318D1	
UEL318-308D1W3	F318D1	44
UEL318-308D1W3	F318D1	
UEL319D1W3	F319D1	24
UEL319-310D1W3	F319D1	53
UEL319-311D1W3	F319D1	
UEL319-312D1W3	F319D1	
UEL320D1W3	F320D1	
UEL320-313D1W3	F320D1	64
UEL320-314D1W3	F320D1	
UEL320-315D1W3	F320D1	
UEL320-400D1W3	F320D1	
UEL321D1W3	F321D1	
UEL322D1W3	F322D1	37

## Square flanged unit, cast housing Eccentric locking collar type

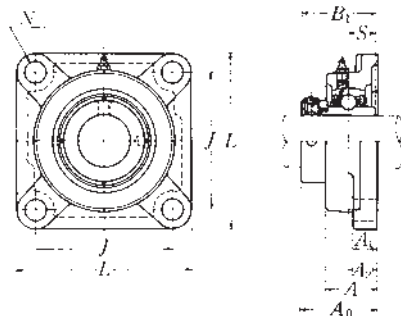

Shaft dia. mm inch	Unit number (1)	Nominal dimensions									Bolt size mm inch
		mm inch									
		L	J	A <sub>2</sub>	A <sub>1</sub>	A	N	A <sub>0</sub>	B <sub>1</sub>	S	
20 3/4	UELFU204D1W3	86	63.5	19	15	29.5	11.5	45.6	43.7	17.1	M10
	UELFU204-012D1W3	3 3/8	2 1/2	3/4	19/32	1 5/32	29/64	1 51/64	1.720	0.673	3/8
25 1 3/16 7/8 15/16 1	UELFU205D1W3	96	70	19	15	30	11.5	45.95	44.4	17.45	M10
	UELFU205-013D1W3										
	UELFU205-014D1W3										
	UELFU205-015D1W3	3 25/32	2 3/4	3/4	19/32	1 3/16	29/64	1 13/16	1.748	0.687	3/8
	UELFU205-100D1W3										
30 1 1/16 1 1/8 1 1/16 1 1/4	UELFU206D1W3	109	82.5	20	16	33	11.5	50.15	48.4	18.25	M10
	UELFU206-101D1W3										
	UELFU206-102D1W3										
	UELFU206-103D1W3	4 9/32	3 1/4	25/32	5/8	1 5/16	29/64	1 31/32	1.906	0.719	3/8
	UELFU206-104D1W3										
35 1 1/4 1 1/16 1 3/8 1 1/16	UELFU207D1W3	118	92	21	17	36	14	53.3	51.1	18.8	M12
	UELFU207-104D1W3										
	UELFU207-105D1W3										
	UELFU207-106D1W3	4 21/32	3 5/8	53/64	21/32	1 13/32	35/64	2 3/32	2.012	0.740	1/2
	UELFU207-107D1W3										
40 1 1/2 1 9/16	UELFU208D1W3	131	101.5	24	17	39	14	58.9	56.3	21.4	M12
	UELFU208-108D1W3										
	UELFU208-109D1W3	5 5/32	4	15/16	21/32	1 17/32	35/64	2 5/16	2.217	0.843	1/2
45 1 5/8 1 1/16 1 3/4	UELFU209D1W3	137	105	24	18	40	16	58.9	56.3	21.4	M14
	UELFU209-110D1W3										
	UELFU209-111D1W3										
	UELFU209-112D1W3	5 13/32	4 9/64	15/16	23/32	1 9/16	5/8	2 5/16	2.217	0.843	1/2
50 1 13/16 1 7/8 1 15/16 2	UELFU210D1W3	144	111	28	20	46	18	66.1	62.7	24.6	M16
	UELFU210-113D1W3										
	UELFU210-114D1W3										
	UELFU210-115D1W3	5 21/32	4 3/8	1 7/64	25/32	1 13/16	45/64	2 39/64	2.469	0.969	5/8
	UELFU210-200D1W3										

Note (1) These numbers indicate relubricatable type. If maintenance free type is needed, please order without suffix "D1".

Remarks Please refer to page A21 for size of grease fitting.

Bearing number	Housing number	Mass of unit	
		kg	lb
UEL204D1W3	FU204D1	0.8	
UEL204-012D1W3	FU204D1	1.8	
UEL205D1W3	FU205D1	1.0	
UEL205-013D1W3	FU205D1		
UEL205-014D1W3	FU205D1	2.2	
UEL205-015D1W3	FU205D1		
UEL205-100D1W3	FU205D1		
UEL206D1W3	FU206D1	1.4	
UEL206-101D1W3	FU206D1		
UEL206-102D1W3	FU206D1	3.1	
UEL206-103D1W3	FU206D1		
UEL206-104D1W3	FU206D1		
UEL207D1W3	FU207D1	1.7	
UEL207-104D1W3	FU207D1		
UEL207-105D1W3	FU207D1	3.7	
UEL207-106D1W3	FU207D1		
UEL207-107D1W3	FU207D1		
UEL208D1W3	FU208D1	2.2	
UEL208-108D1W3	FU208D1	4.9	
UEL208-109D1W3	FU208D1		
UEL209D1W3	FU209D1	2.4	
UEL209-110D1W3	FU209D1		
UEL209-111D1W3	FU209D1	5.3	
UEL209-112D1W3	FU209D1		
UEL210D1W3	FU210D1	2.9	
UEL210-113D1W3	FU210D1		
UEL210-114D1W3	FU210D1	6.4	
UEL210-115D1W3	FU210D1		
UEL210-200D1W3	FU210D1		



## Square flanged unit, cast housing Eccentric locking collar type

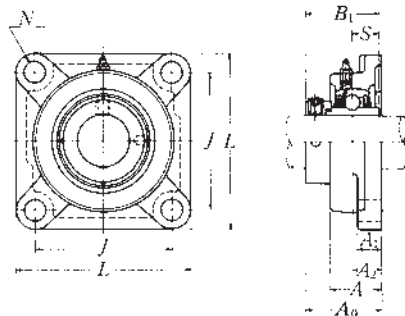

Shaft dia. mm inch	Unit number (1)	Nominal dimensions									Bolt size mm inch
		mm inch									
		L	J	A <sub>2</sub>	A <sub>1</sub>	A	N	A <sub>0</sub>	B <sub>1</sub>	S	
55	<b>UELFU211D1W3</b>	163	130	31	21	49	18	74.65	71.4	27.75	M16
2	<b>UELFU211-200D1W3</b>										
2 <sup>1</sup> / <sub>16</sub>	<b>UELFU211-201D1W3</b>	6 <sup>13</sup> / <sub>32</sub>	5 <sup>1</sup> / <sub>8</sub>	1 <sup>7</sup> / <sub>32</sub>	1 <sup>3</sup> / <sub>16</sub>	1 <sup>15</sup> / <sub>16</sub>	4 <sup>5</sup> / <sub>64</sub>	2 <sup>15</sup> / <sub>16</sub>	2.811	1.093	5/8
2 <sup>1</sup> / <sub>8</sub>	<b>UELFU211-202D1W3</b>										
2 <sup>3</sup> / <sub>16</sub>	<b>UELFU211-203D1W3</b>										
60	<b>UELFU212D1W3</b>	175	143	34	21	53	18	80.85	77.8	30.95	M16
2 <sup>1</sup> / <sub>4</sub>	<b>UELFU212-204D1W3</b>										
2 <sup>5</sup> / <sub>16</sub>	<b>UELFU212-205D1W3</b>	6 <sup>7</sup> / <sub>8</sub>	5 <sup>5</sup> / <sub>8</sub>	1 <sup>11</sup> / <sub>32</sub>	1 <sup>3</sup> / <sub>16</sub>	2 <sup>3</sup> / <sub>32</sub>	4 <sup>5</sup> / <sub>64</sub>	3 <sup>3</sup> / <sub>16</sub>	3.063	1.219	5/8
2 <sup>3</sup> / <sub>8</sub>	<b>UELFU212-206D1W3</b>										
2 <sup>1</sup> / <sub>16</sub>	<b>UELFU212-207D1W3</b>										
65	<b>UELFU213D1W3</b>	187	149	38	22	59	20.5	89.55	85.7	34.15	M18
2 <sup>1</sup> / <sub>2</sub>	<b>UELFU213-208D1W3</b>										
2 <sup>1</sup> / <sub>16</sub>	<b>UELFU213-209D1W3</b>	7 <sup>3</sup> / <sub>8</sub>	5 <sup>55</sup> / <sub>64</sub>	1 <sup>1</sup> / <sub>2</sub>	7/8	2 <sup>5</sup> / <sub>16</sub>	1 <sup>3</sup> / <sub>16</sub>	3 <sup>17</sup> / <sub>32</sub>	3.374	1.344	5/8
70	<b>UELFU214D1W3</b>	193	152	38	22	62	20.5	89.55	85.7	34.15	M18
2 <sup>5</sup> / <sub>8</sub>	<b>UELFU214-210D1W3</b>										
2 <sup>1</sup> / <sub>16</sub>	<b>UELFU214-211D1W3</b>	7 <sup>19</sup> / <sub>32</sub>	5 <sup>63</sup> / <sub>64</sub>	1 <sup>1</sup> / <sub>2</sub>	7/8	2 <sup>7</sup> / <sub>16</sub>	1 <sup>3</sup> / <sub>16</sub>	3 <sup>17</sup> / <sub>32</sub>	3.374	1.344	5/8
2 <sup>3</sup> / <sub>4</sub>	<b>UELFU214-212D1W3</b>										
75	<b>UELFU215D1W3</b>	200	159	41	22	64	20.5	95.7	92	37.3	M18
2 <sup>13</sup> / <sub>16</sub>	<b>UELFU215-213D1W3</b>										
2 <sup>7</sup> / <sub>8</sub>	<b>UELFU215-214D1W3</b>	7 <sup>7</sup> / <sub>8</sub>	6 <sup>17</sup> / <sub>64</sub>	1 <sup>39</sup> / <sub>64</sub>	7/8	2 <sup>33</sup> / <sub>64</sub>	1 <sup>1</sup> / <sub>16</sub>	3 <sup>49</sup> / <sub>64</sub>	3.622	1.469	5/8
2 <sup>15</sup> / <sub>16</sub>	<b>UELFU215-215D1W3</b>										
3	<b>UELFU215-300D1W3</b>										

Note (1) These numbers indicate relubricatable type. If maintenance free type is needed, please order without suffix "D1".

Remarks Please refer to page A21 for size of grease fitting.

Bearing number	Housing number	Mass of unit
		kg lb
UEL211D1W3	FU211D1	3.9
UEL211-200D1W3	FU211D1	8.6
UEL211-201D1W3	FU211D1	
UEL211-202D1W3	FU211D1	
UEL211-203D1W3	FU211D1	
UEL212D1W3	FU212D1	4.7
UEL212-204D1W3	FU212D1	10
UEL212-205D1W3	FU212D1	
UEL212-206D1W3	FU212D1	
UEL212-207D1W3	FU212D1	
UEL213D1W3	FU213D1	6.3
UEL213-208D1W3	FU213D1	14
UEL213-209D1W3	FU213D1	
UEL214D1W3	FU214D1	6.7
UEL214-210D1W3	FU214D1	15
UEL214-211D1W3	FU214D1	
UEL214-212D1W3	FU214D1	
UEL215D1W3	FU215D1	7.0
UEL215-213D1W3	FU215D1	15
UEL215-214D1W3	FU215D1	
UEL215-215D1W3	FU215D1	
UEL215-300D1W3	FU215D1	

## Square flanged unit, cast housing with spigot joint Eccentric locking collar type

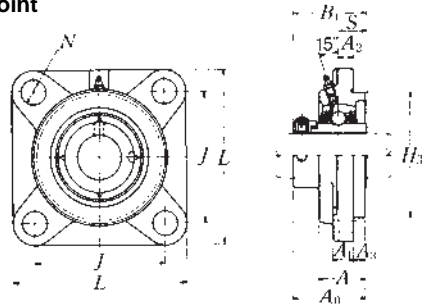

Shaft dia. mm inch	Unit number (1)	Nominal dimensions											Bolt size mm inch
		mm inch											
		L	J	A <sub>2</sub>	N	A <sub>3</sub>	A <sub>1</sub>	A	H <sub>3</sub>	A <sub>0</sub>	B <sub>1</sub>	S	
25 1 3/16 7/8 1 1/16 1	UELFS305D1W3	110	80	9	16	7	13	29	80	46.1	46.8	16.7	M14
	UELFS305-013D1W3												
	UELFS305-014D1W3	4 11/32	3 5/32	23/64	5/8	9/32	1/2	1 9/64	3.1496	1 19/16	1.843	0.657	1/2
	UELFS305-015D1W3												
	UELFS305-100D1W3												
30 1 1/16 1 1/8 1 3/16	UELFS306D1W3	125	95	10	16	8	15	32	90	50.5	50	17.5	M14
	UELFS306-101D1W3												
	UELFS306-102D1W3	4 29/32	3 47/64	25/64	5/8	5/16	19/32	1 17/64	3.5433	1 63/64	1.969	0.689	1/2
	UELFS306-103D1W3												
35 1 1/4 1 5/16 1 3/8 1 7/16	UELFS307D1W3	135	100	11	19	9	16	36	100	53.3	51.6	18.3	M16
	UELFS307-104D1W3												
	UELFS307-105D1W3	5 5/16	3 15/16	7/16	3/4	23/64	5/8	1 13/32	3.9370	2 3/32	2.031	0.720	5/8
	UELFS307-106D1W3												
	UELFS307-107D1W3												
40 1 1/2 1 7/16	UELFS308D1W3	150	112	13	19	10	17	40	115	60.3	57.1	19.8	M16
	UELFS308-108D1W3												
	UELFS308-109D1W3	5 29/32	4 15/32	33/64	3/4	25/64	21/32	1 9/16	4.5276	2 3/8	2.248	0.780	5/8
45 1 5/8 1 11/16 1 3/4	UELFS309D1W3	160	125	14	19	11	18	44	125	63.9	58.7	19.8	M16
	UELFS309-110D1W3												
	UELFS309-111D1W3	6 5/16	4 59/64	35/64	3/4	7/16	23/32	1 47/64	4.9213	2 33/64	2.311	0.780	5/8
	UELFS309-112D1W3												
50 1 3/16 1 1/6 1 5/16	UELFS310D1W3	175	132	16	23	12	19	48	140	70	66.6	24.6	M20
	UELFS310-113D1W3												
	UELFS310-114D1W3	6 7/8	5 19/64	5/8	29/32	15/32	3/4	1 57/64	5.5118	2 3/4	2.622	0.969	3/4
	UELFS310-115D1W3												

Note (1) These numbers indicate relubricatable type. If maintenance free type is needed, please order without suffix "D1".

Remarks Please refer to page A21 for size of grease fitting.

Bearing number	Housing number	Mass of unit
		kg lb
UEL305D1W3	FS305D1	1.3
UEL305-013D1W3	FS305D1	
UEL305-014D1W3	FS305D1	2.9
UEL305-015D1W3	FS305D1	
UEL305-100D1W3	FS305D1	
UEL306D1W3	FS306D1	1.9
UEL306-101D1W3	FS306D1	
UEL306-102D1W3	FS306D1	4.2
UEL306-103D1W3	FS306D1	
UEL307D1W3	FS307D1	2.3
UEL307-104D1W3	FS307D1	
UEL307-105D1W3	FS307D1	5.1
UEL307-106D1W3	FS307D1	
UEL307-107D1W3	FS307D1	
UEL308D1W3	FS308D1	3.3
UEL308-108D1W3	FS308D1	7.3
UEL308-109D1W3	FS308D1	
UEL309D1W3	FS309D1	4.0
UEL309-110D1W3	FS309D1	
UEL309-111D1W3	FS309D1	8.8
UEL309-112D1W3	FS309D1	
UEL310D1W3	FS310D1	5.2
UEL310-113D1W3	FS310D1	
UEL310-114D1W3	FS310D1	11
UEL310-115D1W3	FS310D1	

## Square flanged unit, cast housing with spigot joint Eccentric locking collar type

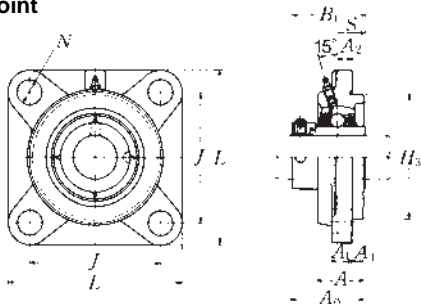

Shaft dia. mm inch	Unit number (1)	Nominal dimensions											Bolt size mm inch
		mm inch											
		<i>L</i>	<i>J</i>	<i>A</i> <sub>2</sub>	<i>N</i>	<i>A</i> <sub>3</sub>	<i>A</i> <sub>1</sub>	<i>A</i>	<i>H</i> <sub>3</sub>	<i>A</i> <sub>0</sub>	<i>B</i> <sub>1</sub>	<i>S</i>	
55 2 2 1/16 2 1/8 2 3/16	UELFS311D1W3 UELFS311-200D1W3 UELFS311-201D1W3 UELFS311-202D1W3 UELFS311-203D1W3	185 7 9/32	140 5 33/64	17 43/64	23 29/32	13 33/64	20 25/32	52 2 3/64	150 5.9055	75.2 2 61/64	73 2.874	27.8 1.094	M20 3/4
60 2 1/4 2 5/16 2 3/8 2 7/16	UELFS312D1W3 UELFS312-204D1W3 UELFS312-205D1W3 UELFS312-206D1W3 UELFS312-207D1W3	195 7 11/16	150 5 29/32	19 3/4	23 29/32	14 35/64	22 7/8	56 2 13/16	160 6.2992	81.45 3 13/64	79.4 3.126	30.95 1.219	M20 3/4
65 2 1/2 2 9/16	UELFS313D1W3 UELFS313-208D1W3 UELFS313-209D1W3	208 8 3/16	166 6 17/32	15 19/32	23 29/32	18 45/64	22 7/8	58 2 9/32	175 6.8898	86.15 3 25/64	85.7 3.374	32.55 1.281	M20 3/4
70 2 5/8 2 11/16 2 3/4	UELFS314D1W3 UELFS314-210D1W3 UELFS314-211D1W3 UELFS314-212D1W3	226 8 29/32	178 7 1/64	18 45/64	25 63/64	18 45/64	25 31/32	61 2 13/32	185 7.2835	93.95 3 45/64	92.1 3.626	34.15 1.344	M22 7/8
75 2 3/16 2 7/8 2 5/16 3	UELFS315D1W3 UELFS315-213D1W3 UELFS315-214D1W3 UELFS315-215D1W3 UELFS315-300D1W3	236 9 9/32	184 7 1/4	21 53/64	25 63/64	18 45/64	25 31/32	66 2 19/32	200 7.8740	101.7 4	100 3.937	37.3 1.469	M22 7/8
80 3 1/16 3 1/8 3 3/16	UELFS316D1W3 UELFS316-301D1W3 UELFS316-302D1W3 UELFS316-303D1W3	250 9 27/32	196 7 23/32	18 45/64	31 1 7/32	20 25/32	27 1 1/16	68 2 43/64	210 8.2677	103.9 4 3/32	106.4 4.189	40.5 1.594	M27 1

Note (1) These numbers indicate relubricatable type. If maintenance free type is needed, please order without suffix "D1".

Remarks Please refer to page A21 for size of grease fitting.

Bearing number	Housing number	Mass of unit
		kg lb
UEL311D1W3	FS311D1	6.2
UEL311-200D1W3	FS311D1	14
UEL311-201D1W3	FS311D1	
UEL311-202D1W3	FS311D1	
UEL311-203D1W3	FS311D1	
UEL312D1W3	FS312D1	7.4
UEL312-204D1W3	FS312D1	16
UEL312-205D1W3	FS312D1	
UEL312-206D1W3	FS312D1	
UEL312-207D1W3	FS312D1	
UEL313D1W3	FS313D1	9.0
UEL313-208D1W3	FS313D1	20
UEL313-209D1W3	FS313D1	
UEL314D1W3	FS314D1	11
UEL314-210D1W3	FS314D1	24
UEL314-211D1W3	FS314D1	
UEL314-212D1W3	FS314D1	
UEL315D1W3	FS315D1	13
UEL315-213D1W3	FS315D1	29
UEL315-214D1W3	FS315D1	
UEL315-215D1W3	FS315D1	
UEL315-300D1W3	FS315D1	
UEL316D1W3	FS316D1	16
UEL316-301D1W3	FS316D1	35
UEL316-302D1W3	FS316D1	
UEL316-303D1W3	FS316D1	

## Square flanged unit, cast housing with spigot joint Eccentric locking collar type

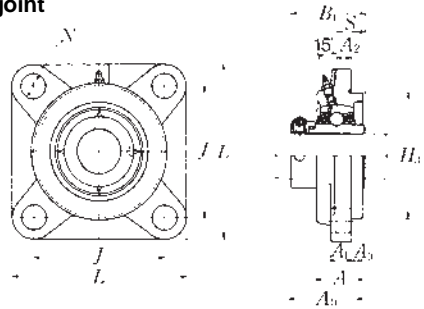

Shaft dia. mm inch	Unit number (1)	Nominal dimensions											Bolt size mm inch
		mm inch											
		<i>L</i>	<i>J</i>	<i>A</i> <sub>2</sub>	<i>N</i>	<i>A</i> <sub>3</sub>	<i>A</i> <sub>1</sub>	<i>A</i>	<i>H</i> <sub>3</sub>	<i>A</i> <sub>0</sub>	<i>B</i> <sub>1</sub>	<i>S</i>	
85 3 1/4	UELFS317D1W3	260	204	24	31	20	27	74	220	111.45	109.5	42.05	M27
3 5/16	UELFS317-304D1W3	10 1/4	8 1/2	1 5/16	1 1/32	25/32	1 1/16	2 29/32	8.6614	4 25/64	4.311	1.656	1
3 7/16	UELFS317-305D1W3												
3 7/8	UELFS317-307D1W3												
90 3 7/16	UELFS318D1W3	280	216	24	35	20	30	76	240	116.25	115.9	43.65	M30
3 1/2	UELFS318-307D1W3	11 1/32	8 1/2	1 5/16	1 3/8	25/32	1 3/16	2 53/64	9.4488	4 37/64	4.563	1.719	1 1/8
3 7/8	UELFS318-308D1W3												
95 3 5/8	UELFS319D1W3	290	228	39	35	20	30	94	250	142.4	122.3	38.9	M30
3 11/16	UELFS319-310D1W3	11 13/32	8 31/32	1 7/32	1 3/8	25/32	1 3/16	3 45/64	9.8425	5 39/64	4.815	1.531	1 1/8
3 3/4	UELFS319-311D1W3												
3 7/8	UELFS319-312D1W3												
100 3 3/8	UELFS320D1W3	310	242	39	38	20	32	94	260	137.6	128.6	50	M33
3 7/8	UELFS320-313D1W3	12 7/32	9 17/32	1 17/32	1 1/2	25/32	1 1/4	3 45/64	10.2362	5 27/64	5.063	1.969	1 1/4
3 15/16	UELFS320-314D1W3												
3 7/8	UELFS320-315D1W3												
4	UELFS320-400D1W3												
105 3 3/8	UELFS321D1W3	310	242	39	38	20	32	94	260	150.3	139.7	48.4	M33
110 4 1/8	UELFS322D1W3	340	266	35	41	25	35	96	300	152.1	141.3	49.2	M36

Note (1) These numbers indicate relubricatable type. If maintenance free type is needed, please order without suffix "D1".

Remarks Please refer to page A21 for size of grease fitting.

Bearing number	Housing number	Mass of unit
		kg lb
UEL317D1W3	FS317D1	18
UEL317-304D1W3	FS317D1	40
UEL317-305D1W3	FS317D1	
UEL317-307D1W3	FS317D1	
UEL318D1W3	FS318D1	22
UEL318-307D1W3	FS318D1	49
UEL318-308D1W3	FS318D1	
UEL319D1W3	FS319D1	26
UEL319-310D1W3	FS319D1	57
UEL319-311D1W3	FS319D1	
UEL319-312D1W3	FS319D1	
UEL320D1W3	FS320D1	31
UEL320-313D1W3	FS320D1	68
UEL320-314D1W3	FS320D1	
UEL320-315D1W3	FS320D1	
UEL320-400D1W3	FS320D1	
UEL321D1W3	FS321D1	31
UEL322D1W3	FS322D1	41



## Round flanged unit, cast housing with spigot joint Eccentric locking collar type

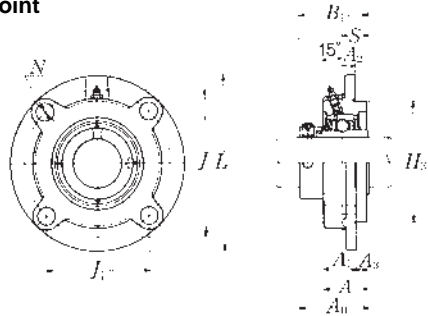

Shaft dia. mm inch	Unit number (1)	Nominal dimensions												Bolt size mm inch
		mm inch												
		L	J	(J <sub>1</sub> )	A <sub>2</sub>	N	A <sub>3</sub>	A <sub>1</sub>	A	H <sub>3</sub>	A <sub>0</sub>	B <sub>1</sub>	S	
20 3/4	UELFC204D1W3	100	78	55.2	10	12	5	20.5	25.5	62	41.6	43.7	17.1	M10
	UELFC204-012D1W3	3 <sup>15</sup> / <sub>16</sub>	3 <sup>5</sup> / <sub>64</sub>	2 <sup>11</sup> / <sub>64</sub>	<sup>25</sup> / <sub>64</sub>	<sup>15</sup> / <sub>32</sub>	<sup>13</sup> / <sub>64</sub>	<sup>13</sup> / <sub>16</sub>	1	2.4409	1 <sup>41</sup> / <sub>64</sub>	1.720	0.673	<sup>3</sup> / <sub>8</sub>
25 13/16 7/8 15/16 1	UELFC205D1W3	115	90	63.6	10	12	6	21	27	70	42.95	44.4	17.45	M10
	UELFC205-013D1W3													
	UELFC205-014D1W3	4 <sup>17</sup> / <sub>32</sub>	3 <sup>35</sup> / <sub>64</sub>	2 <sup>1</sup> / <sub>2</sub>	<sup>25</sup> / <sub>64</sub>	<sup>15</sup> / <sub>32</sub>	<sup>15</sup> / <sub>64</sub>	<sup>13</sup> / <sub>16</sub>	1 <sup>1</sup> / <sub>16</sub>	2.7559	1 <sup>11</sup> / <sub>16</sub>	1.748	0.687	<sup>3</sup> / <sub>8</sub>
	UELFC205-015D1W3													
	UELFC205-100D1W3													
30 1 1/16 1 1/8 1 1/16 1 1/4	UELFC206D1W3	125	100	70.7	10	12	8	23	31	80	48.15	48.4	18.25	M10
	UELFC206-101D1W3													
	UELFC206-102D1W3	4 <sup>29</sup> / <sub>32</sub>	3 <sup>15</sup> / <sub>16</sub>	2 <sup>25</sup> / <sub>32</sub>	<sup>25</sup> / <sub>64</sub>	<sup>15</sup> / <sub>32</sub>	<sup>5</sup> / <sub>16</sub>	<sup>29</sup> / <sub>32</sub>	1 <sup>7</sup> / <sub>32</sub>	3.1496	1 <sup>57</sup> / <sub>64</sub>	1.906	0.719	<sup>3</sup> / <sub>8</sub>
	UELFC206-103D1W3													
	UELFC206-104D1W3													
35 1 1/4 1 1/16 1 3/8 1 1/16	UELFC207D1W3	135	110	77.8	11	14	8	26	34	90	51.3	51.1	18.8	M12
	UELFC207-104D1W3													
	UELFC207-105D1W3	5 <sup>5</sup> / <sub>16</sub>	4 <sup>21</sup> / <sub>64</sub>	3 <sup>1</sup> / <sub>16</sub>	<sup>7</sup> / <sub>16</sub>	<sup>35</sup> / <sub>64</sub>	<sup>5</sup> / <sub>16</sub>	1 <sup>1</sup> / <sub>32</sub>	1 <sup>11</sup> / <sub>32</sub>	3.5433	2 <sup>1</sup> / <sub>64</sub>	2.012	0.740	<sup>7</sup> / <sub>16</sub>
	UELFC207-106D1W3													
	UELFC207-107D1W3													
40 1 1/2 1 1/16	UELFC208D1W3	145	120	84.9	11	14	10	26	36	100	55.9	56.3	21.4	M12
	UELFC208-108D1W3	5 <sup>23</sup> / <sub>32</sub>	4 <sup>23</sup> / <sub>32</sub>	3 <sup>11</sup> / <sub>32</sub>	<sup>7</sup> / <sub>16</sub>	<sup>35</sup> / <sub>64</sub>	<sup>25</sup> / <sub>64</sub>	1 <sup>1</sup> / <sub>32</sub>	1 <sup>27</sup> / <sub>64</sub>	3.9370	2 <sup>13</sup> / <sub>64</sub>	2.217	0.843	<sup>7</sup> / <sub>16</sub>
	UELFC208-109D1W3													
45 1 5/8 1 1/16 1 3/4	UELFC209D1W3	160	132	93.3	10	16	12	26	38	105	56.9	56.3	21.4	M14
	UELFC209-110D1W3													
	UELFC209-111D1W3	6 <sup>5</sup> / <sub>16</sub>	5 <sup>13</sup> / <sub>64</sub>	3 <sup>43</sup> / <sub>64</sub>	<sup>25</sup> / <sub>64</sub>	<sup>5</sup> / <sub>8</sub>	<sup>15</sup> / <sub>32</sub>	1 <sup>1</sup> / <sub>32</sub>	1 <sup>1</sup> / <sub>2</sub>	4.1339	2 <sup>15</sup> / <sub>64</sub>	2.217	0.843	<sup>1</sup> / <sub>2</sub>
	UELFC209-112D1W3													
50 1 13/16 1 7/8 1 15/16 2	UELFC210D1W3	165	138	97.6	10	16	12	28	40	110	60.1	62.7	24.6	M14
	UELFC210-113D1W3													
	UELFC210-114D1W3	6 <sup>1</sup> / <sub>2</sub>	5 <sup>7</sup> / <sub>16</sub>	3 <sup>27</sup> / <sub>32</sub>	<sup>25</sup> / <sub>64</sub>	<sup>5</sup> / <sub>8</sub>	<sup>15</sup> / <sub>32</sub>	1 <sup>3</sup> / <sub>32</sub>	1 <sup>37</sup> / <sub>64</sub>	4.3307	2 <sup>23</sup> / <sub>64</sub>	2.469	0.969	<sup>1</sup> / <sub>2</sub>
	UELFC210-115D1W3													
	UELFC210-200D1W3													

Note (1) These numbers indicate relubricatable type. If maintenance free type is needed, please order without suffix "D1".

Remarks Please refer to page A21 for size of grease fitting.

Bearing number	Housing number	Mass of unit
		kg lb
UEL204D1W3	FC204D1	0.8
UEL204-012D1W3	FC204D1	1.8
UEL205D1W3	FC205D1	1.1
UEL205-013D1W3	FC205D1	2.4
UEL205-014D1W3	FC205D1	
UEL205-015D1W3	FC205D1	
UEL205-100D1W3	FC205D1	
UEL206D1W3	FC206D1	1.4
UEL206-101D1W3	FC206D1	3.1
UEL206-102D1W3	FC206D1	
UEL206-103D1W3	FC206D1	
UEL206-104D1W3	FC206D1	
UEL207D1W3	FC207D1	1.8
UEL207-104D1W3	FC207D1	4.0
UEL207-105D1W3	FC207D1	
UEL207-106D1W3	FC207D1	
UEL207-107D1W3	FC207D1	
UEL208D1W3	FC208D1	2.1
UEL208-108D1W3	FC208D1	4.6
UEL208-109D1W3	FC208D1	
UEL209D1W3	FC209D1	2.8
UEL209-110D1W3	FC209D1	6.2
UEL209-111D1W3	FC209D1	
UEL209-112D1W3	FC209D1	
UEL210D1W3	FC210D1	3.1
UEL210-113D1W3	FC210D1	6.8
UEL210-114D1W3	FC210D1	
UEL210-115D1W3	FC210D1	
UEL210-200D1W3	FC210D1	

## Round flanged unit, cast housing with spigot joint Eccentric locking collar type

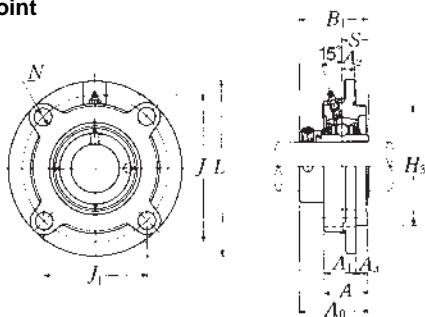

Shaft dia. mm inch	Unit number (1)	Nominal dimensions												Bolt size mm inch
		mm inch												
		<i>L</i>	<i>J</i>	<i>(J<sub>1</sub>)</i>	<i>A<sub>2</sub></i>	<i>N</i>	<i>A<sub>3</sub></i>	<i>A<sub>1</sub></i>	<i>A</i>	<i>H<sub>3</sub></i>	<i>A<sub>0</sub></i>	<i>B<sub>1</sub></i>	<i>S</i>	
55	<b>UELFC211D1W3</b>	185	150	106.1	13	19	12	31	43	125	68.65	71.4	27.75	M16
2	<b>UELFC211-200D1W3</b>													
2 1/16	<b>UELFC211-201D1W3</b>													
2 1/8	<b>UELFC211-202D1W3</b>	7 9/32	5 29/32	4 11/64	33/64	3/4	15/32	1 7/32	1 11/16	4.9213	2 45/64	2.811	1.093	5/8
2 3/16	<b>UELFC211-203D1W3</b>													
60	<b>UELFC212D1W3</b>	195	160	113.1	17	19	12	36	48	135	75.85	77.8	30.95	M16
2 1/4	<b>UELFC212-204D1W3</b>													
2 5/16	<b>UELFC212-205D1W3</b>													
2 3/8	<b>UELFC212-206D1W3</b>	7 11/16	6 19/64	4 29/64	43/64	3/4	15/32	1 13/32	1 57/64	5.3150	2 63/64	3.063	1.219	5/8
2 7/16	<b>UELFC212-207D1W3</b>													
65	<b>UELFC213D1W3</b>	205	170	120.2	16	19	14	36	50	145	81.55	85.7	34.15	M16
2 1/2	<b>UELFC213-208D1W3</b>													
2 5/16	<b>UELFC213-209D1W3</b>	8 1/16	6 1/16	4 47/64	5/8	3/4	35/64	1 13/32	1 31/32	5.7087	3 13/64	3.374	1.344	5/8
70	<b>UELFC214D1W3</b>	215	177	125.2	17	19	14	40	54	150	82.55	85.7	34.15	M16
2 5/8	<b>UELFC214-210D1W3</b>													
2 11/16	<b>UELFC214-211D1W3</b>													
2 3/4	<b>UELFC214-212D1W3</b>	8 15/32	6 31/32	4 59/64	43/64	3/4	35/64	1 37/64	2 1/8	5.9055	3 3/4	3.374	1.344	5/8
75	<b>UELFC215D1W3</b>	220	184	130.1	18	19	16	40	56	160	88.7	92	37.3	M16
2 9/16	<b>UELFC215-213D1W3</b>													
2 7/8	<b>UELFC215-214D1W3</b>													
2 5/16	<b>UELFC215-215D1W3</b>	8 21/32	7 1/4	5 1/8	45/64	3/4	5/8	1 37/64	2 13/64	6.2992	3 31/64	3.622	1.469	5/8
3	<b>UELFC215-300D1W3</b>													

Note (1) These numbers indicate relubricatable type. If maintenance free type is needed, please order without suffix "D1".

Remarks Please refer to page A21 for size of grease fitting.

Bearing number	Housing number	Mass of unit
		kg lb
UEL211D1W3	FC211D1	4.3
UEL211-200D1W3	FC211D1	9.5
UEL211-201D1W3	FC211D1	
UEL211-202D1W3	FC211D1	
UEL211-203D1W3	FC211D1	
UEL212D1W3	FC212D1	5.2
UEL212-204D1W3	FC212D1	11
UEL212-205D1W3	FC212D1	
UEL212-206D1W3	FC212D1	
UEL212-207D1W3	FC212D1	
UEL213D1W3	FC213D1	6.5
UEL213-208D1W3	FC213D1	14
UEL213-209D1W3	FC213D1	
UEL214D1W3	FC214D1	7.4
UEL214-210D1W3	FC214D1	16
UEL214-211D1W3	FC214D1	
UEL214-212D1W3	FC214D1	
UEL215D1W3	FC215D1	7.8
UEL215-213D1W3	FC215D1	17
UEL215-214D1W3	FC215D1	
UEL215-215D1W3	FC215D1	
UEL215-300D1W3	FC215D1	

## Rhombus flanged unit, cast housing Eccentric locking collar type

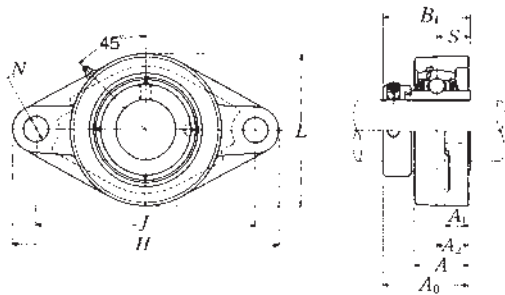

Shaft dia. mm inch	Unit number (1)	Nominal dimensions											Bolt size mm inch
		H	J	A <sub>2</sub>	A <sub>1</sub>	A	N	L	A <sub>0</sub>	B <sub>1</sub>	S	F <sub>min.</sub>	
20 3/4	UELFL204D1W3	113	90	15	11	25.5	12	60	41.6	43.7	17.1	34	M10
	UELFL204-012D1W3	4 7/16	3 5/8	1 9/32	7/16	1	1 15/32	2 3/8	1 1/4	1.720	0.673	1.339	3/8
25 1 13/16 7/8 1 15/16	UELFL205D1W3	130	99	16	13	27	16	68	42.95	44.4	17.45	38	M14
	UELFL205-013D1W3	5 1/8	3 57/64	5/8	1/2	1 1/16	5/8	2 11/16	1 1/16	1.748	0.687	1.496	1/2
	UELFL205-014D1W3												
UELFL205-015D1W3													
1	UELFL205-100D1W3												
30 1 1/16 1 1/8 1 7/16 1 1/4	UELFL206D1W3	148	117	18	13	31	16	80	48.15	48.4	18.25	45	M14
	UELFL206-101D1W3	5 13/16	4 39/64	4 5/64	1/2	1 7/32	5/8	3 5/32	1 57/64	1.906	0.719	1.772	1/2
	UELFL206-102D1W3												
	UELFL206-103D1W3												
UELFL206-104D1W3													
35 1 1/4 1 1/16 1 5/8 1 7/16	UELFL207D1W3	161	130	19	15	34	16	90	51.3	51.1	18.8	51	M14
	UELFL207-104D1W3	6 11/32	5 1/8	3/4	1 9/32	1 11/32	5/8	3 17/32	2 1/64	2.012	0.740	2.008	1/2
	UELFL207-105D1W3												
	UELFL207-106D1W3												
	UELFL207-107D1W3												
UELFL207-107D1W3													
40 1 1/2 1 9/16	UELFL208D1W3	175	144	21	15	36	16	100	55.9	56.3	21.4	57	M14
	UELFL208-108D1W3	6 7/8	5 43/64	5 3/64	1 9/32	1 13/32	5/8	3 15/16	2 13/64	2.217	0.843	2.244	1/2
	UELFL208-109D1W3												
UELFL208-109D1W3													
45 1 5/8 1 11/16 1 3/4	UELFL209D1W3	188	148	22	16	38	19	108	56.9	56.3	21.4	62	M16
	UELFL209-110D1W3	7 13/32	5 53/64	5 5/64	5/8	1 1/2	3/4	4 1/4	2 15/64	2.217	0.843	2.441	5/8
	UELFL209-111D1W3												
	UELFL209-112D1W3												
UELFL209-112D1W3													
50 1 13/16 1 7/8 1 15/16 2	UELFL210D1W3	197	157	22	16	40	19	115	60.1	62.7	24.6	67	M16
	UELFL210-113D1W3	7 3/4	6 3/16	5 5/64	5/8	1 9/16	3/4	4 17/32	2 23/64	2.469	0.969	2.638	5/8
	UELFL210-114D1W3												
	UELFL210-115D1W3												
UELFL210-200D1W3													

Note (1) These numbers indicate relubricatable type. If maintenance free type is needed, please order without suffix "D1".

Remarks Please refer to page A21 for size of grease fitting.

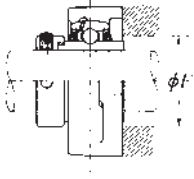

Bearing number	Housing number	Mass of unit	
		kg	lb
UEL204D1W3	FL204D1	0.5	
UEL204-012D1W3	FL204D1	1.1	
UEL205D1W3	FL205D1	0.7	
UEL205-013D1W3	FL205D1		
UEL205-014D1W3	FL205D1		
UEL205-015D1W3	FL205D1	1.5	
UEL205-100D1W3	FL205D1		
UEL206D1W3	FL206D1	1.0	
UEL206-101D1W3	FL206D1		
UEL206-102D1W3	FL206D1		
UEL206-103D1W3	FL206D1	2.2	
UEL206-104D1W3	FL206D1		
UEL207D1W3	FL207D1	1.3	
UEL207-104D1W3	FL207D1		
UEL207-105D1W3	FL207D1		
UEL207-106D1W3	FL207D1	2.9	
UEL207-107D1W3	FL207D1		
UEL208D1W3	FL208D1	1.6	
UEL208-108D1W3	FL208D1		
UEL208-109D1W3	FL208D1	3.5	
UEL209D1W3	FL209D1	2.0	
UEL209-110D1W3	FL209D1		
UEL209-111D1W3	FL209D1	4.4	
UEL209-112D1W3	FL209D1		
UEL210D1W3	FL210D1	2.2	
UEL210-113D1W3	FL210D1		
UEL210-114D1W3	FL210D1		
UEL210-115D1W3	FL210D1	4.9	
UEL210-200D1W3	FL210D1		

## Rhombus flanged unit, cast housing Eccentric locking collar type

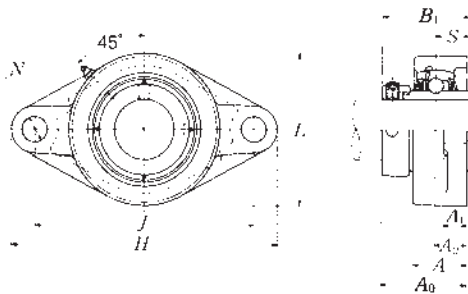

Shaft dia.  mm inch	Unit number (1)	Nominal dimensions											Bolt size  mm inch
		mm inch											
		H	J	A <sub>2</sub>	A <sub>1</sub>	A	N	L	A <sub>0</sub>	B <sub>1</sub>	S	F <sub>min.</sub>	
55 2 2 1/16 2 1/8 2 3/16	UELFL211D1W3 UELFL211-200D1W3 UELFL211-201D1W3 UELFL211-202D1W3 UELFL211-203D1W3	224	184	25	18	43	19	130	68.65	71.4	27.75	73	M16
		8 13/16	7 1/4	63/64	23/32	1 1/16	3/4	5 1/8	2 45/64	2.811	1.093	2.874	5/8
60 2 1/4 2 5/16 2 3/8 2 7/16	UELFL212D1W3 UELFL212-204D1W3 UELFL212-205D1W3 UELFL212-206D1W3 UELFL212-207D1W3	250	202	29	18	48	23	140	75.85	77.8	30.95	81	M20
		9 27/32	7 61/64	1 9/64	23/32	1 7/8	2 9/32	5 1/2	2 63/64	3.063	1.219	3.189	3/4
65 2 1/2 2 5/16	UELFL213D1W3 UELFL213-208D1W3 UELFL213-209D1W3	258	210	30	22	50	23	155	81.55	85.7	34.15	87	M20
		10 5/32	8 17/64	1 3/16	7/8	1 31/32	2 9/32	6 3/32	3 13/64	3.374	1.344	3.425	3/4
70 2 5/8 2 11/16 2 3/4	UELFL214D1W3 UELFL214-210D1W3 UELFL214-211D1W3 UELFL214-212D1W3	265	216	31	22	54	23	160	82.55	85.7	34.15	91	M20
		10 7/16	8 1/2	1 7/32	7/8	2 1/8	2 9/32	6 5/16	3 1/4	3.374	1.344	3.583	3/4
75 2 13/16 2 7/8 2 15/16 3	UELFL215D1W3 UELFL215-213D1W3 UELFL215-214D1W3 UELFL215-215D1W3 UELFL215-300D1W3	275	225	34	22	56	23	165	88.7	92	37.3	97	M20
		10 13/16	8 55/64	1 11/32	7/8	2 7/32	2 9/32	6 1/2	3 31/64	3.622	1.469	3.819	3/4

Note (1) These numbers indicate relubricatable type. If maintenance free type is needed, please order without suffix "D1".

Remarks Please refer to page A21 for size of grease fitting.

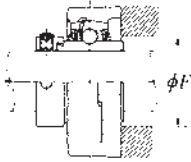

Bearing number	Housing number	Mass of unit
		kg lb
UEL211D1W3	FL211D1	3.2
UEL211-200D1W3	FL211D1	7.1
UEL211-201D1W3	FL211D1	
UEL211-202D1W3	FL211D1	
UEL211-203D1W3	FL211D1	
UEL212D1W3	FL212D1	
UEL212-204D1W3	FL212D1	9.0
UEL212-205D1W3	FL212D1	
UEL212-206D1W3	FL212D1	
UEL212-207D1W3	FL212D1	
UEL213D1W3	FL213D1	
UEL213-208D1W3	FL213D1	12
UEL213-209D1W3	FL213D1	
UEL214D1W3	FL214D1	5.8
UEL214-210D1W3	FL214D1	13
UEL214-211D1W3	FL214D1	
UEL214-212D1W3	FL214D1	
UEL215D1W3	FL215D1	6.3
UEL215-213D1W3	FL215D1	14
UEL215-214D1W3	FL215D1	
UEL215-215D1W3	FL215D1	
UEL215-300D1W3	FL215D1	



## Rhombus flanged unit, cast housing Eccentric locking collar type

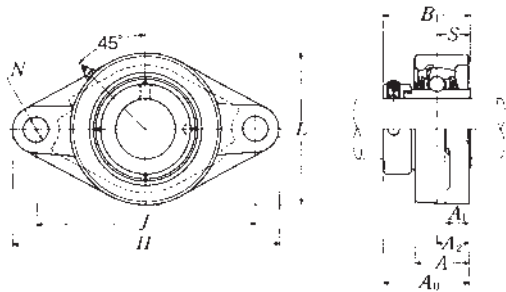

Shaft dia. mm inch	Unit number <sup>(1)</sup> / <sub>(2)</sub>	Nominal dimensions											Bolt size mm inch
		H	J	A <sub>2</sub>	A <sub>1</sub>	A	N	L	A <sub>0</sub>	B <sub>1</sub>	S	F min.	
25 1 3/16 7/8 1 5/16 1	UELFL305D1W3 UELFL305-013D1W3 UELFL305-014D1W3 UELFL305-015D1W3 UELFL305-100D1W3	150	113	16	13	29	19	80	46.1	46.8	16.7	41	M16 5/8
30 1 1/16 1 1/8 1 3/16	UELFL306D1W3 UELFL306-101D1W3 UELFL306-102D1W3 UELFL306-103D1W3	180	134	18	15	32	23	90	50.5	50	17.5	49	M20 3/4
35 1 1/4 1 5/16 1 3/8 1 7/16	UELFL307D1W3 UELFL307-104D1W3 UELFL307-105D1W3 UELFL307-106D1W3 UELFL307-107D1W3	185	141	20	16	36	23	100	53.3	51.6	18.3	–	M20 3/4
40 1 1/2 1 7/16	UELFL308D1W3 UELFL308-108D1W3 UELFL308-109D1W3	200	158	23	17	40	23	112	60.3	57.1	19.8	–	M20 3/4
45 1 5/8 1 11/16 1 3/4	UELFL309D1W3 UELFL309-110D1W3 UELFL309-111D1W3 UELFL309-112D1W3	230	177	25	18	44	25	125	63.9	58.7	19.8	–	M22 7/8
50 1 3/16 1 1/6 1 5/16	UELFL310D1W3 UELFL310-113D1W3 UELFL310-114D1W3 UELFL310-115D1W3	240	187	28	19	48	25	140	70	66.6	24.6	–	M22 7/8

Notes <sup>(1)</sup> These numbers indicate relubricatable type. If maintenance free type is needed, please order without suffix "D1".

<sup>(2)</sup> Inner race face does not protrude from the housing face except UELFL305 and UELFL316.

Remarks Please refer to page A21 for size of grease fitting.

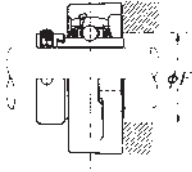

Bearing number	Housing number	Mass of unit
		kg lb
UEL305D1W3	FL305D1	1.0
UEL305-013D1W3	FL305D1	2.2
UEL305-014D1W3	FL305D1	
UEL305-015D1W3	FL305D1	
UEL305-100D1W3	FL305D1	
UEL306D1W3	FL306D1	1.6
UEL306-101D1W3	FL306D1	3.5
UEL306-102D1W3	FL306D1	
UEL306-103D1W3	FL306D1	
UEL307D1W3	FL307D1	1.8
UEL307-104D1W3	FL307D1	4.0
UEL307-105D1W3	FL307D1	
UEL307-106D1W3	FL307D1	
UEL307-107D1W3	FL307D1	
UEL308D1W3	FL308D1	2.3
UEL308-108D1W3	FL308D1	5.1
UEL308-109D1W3	FL308D1	
UEL309D1W3	FL309D1	3.1
UEL309-110D1W3	FL309D1	6.8
UEL309-111D1W3	FL309D1	
UEL309-112D1W3	FL309D1	
UEL310D1W3	FL310D1	4.2
UEL310-113D1W3	FL310D1	9.3
UEL310-114D1W3	FL310D1	
UEL310-115D1W3	FL310D1	

## Rhombus flanged unit, cast housing Eccentric locking collar type

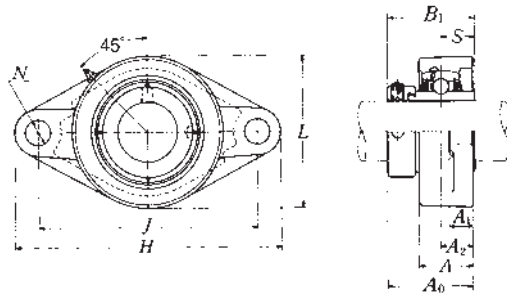

Shaft dia. mm inch	Unit number <sup>(1)(2)</sup>	Nominal dimensions											Bolt size mm inch
		H	J	A <sub>2</sub>	A <sub>1</sub>	A	N	L	A <sub>0</sub>	B <sub>1</sub>	S	F min.	
55 2 2 1/16 2 1/8 2 3/16	UELFL311D1W3 UELFL311-200D1W3 UELFL311-201D1W3 UELFL311-202D1W3 UELFL311-203D1W3	250 9 27/32	198 7 51/64	30 1 3/16	20 25/32	52 2 1/16	25 63/64	150 5 29/32	75.2 2 81/64	73 2.874	27.8 1.094	-	M22 7/8
60 2 1/4 2 5/16 2 3/8 2 7/16	UELFL312D1W3 UELFL312-204D1W3 UELFL312-205D1W3 UELFL312-206D1W3 UELFL312-207D1W3	270 10 5/8	212 8 11/32	33 1 19/64	22 7/8	56 2 7/32	31 1 1/32	160 6 5/16	81.45 3 13/64	79.4 3.126	30.95 1.219	-	M27 1
65 2 1/2 2 5/8	UELFL313D1W3 UELFL313-208D1W3 UELFL313-209D1W3	295 11 5/8	240 9 29/64	33 1 19/64	25 31/32	58 2 9/32	31 1 7/32	175 6 7/8	86.15 3 25/64	85.7 3.374	32.55 1.281	93 3.661	M27 1
70 2 5/8 2 11/16 2 3/4	UELFL314D1W3 UELFL314-210D1W3 UELFL314-211D1W3 UELFL314-212D1W3	315 12 13/32	250 9 27/32	36 1 27/64	28 1 3/32	61 2 13/32	35 1 3/8	185 7 9/32	93.95 3 45/64	92.1 3.626	34.15 1.344	-	M30 1 1/8
75 2 3/16 2 7/8 2 5/16 3	UELFL315D1W3 UELFL315-213D1W3 UELFL315-214D1W3 UELFL315-215D1W3 UELFL315-300D1W3	320 12 19/32	260 10 15/64	39 1 17/32	30 1 3/16	66 2 19/32	35 1 3/8	195 7 11/16	101.7 4	100 3.937	37.3 1.469	106 4.173	M30 1 1/8
80 3 1/16 3 3/8 3 3/16	UELFL316D1W3 UELFL316-301D1W3 UELFL316-302D1W3 UELFL316-303D1W3	355 13 31/32	285 11 7/32	38 1 1/2	32 1 1/4	68 2 11/16	38 1 1/2	210 8 9/32	103.9 4 3/32	106.4 4.189	40.5 1.594	112 4.409	M33 1 1/4

Notes (1) These numbers indicate relubricatable type. If maintenance free type is needed, please order without suffix "D1".

(2) Inner race face does not protrude from the housing face except UELFL305 and UELFL316.

Remarks Please refer to page A21 for size of grease fitting.

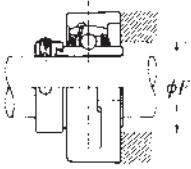

Bearing number	Housing number	Mass of unit
		kg lb
UEL311D1W3	FL311D1	4.9
UEL311-200D1W3	FL311D1	11
UEL311-201D1W3	FL311D1	
UEL311-202D1W3	FL311D1	
UEL311-203D1W3	FL311D1	
UEL312D1W3	FL312D1	
UEL312-204D1W3	FL312D1	13
UEL312-205D1W3	FL312D1	
UEL312-206D1W3	FL312D1	
UEL312-207D1W3	FL312D1	
UEL313D1W3	FL313D1	
UEL313-208D1W3	FL313D1	18
UEL313-209D1W3	FL313D1	
UEL314D1W3	FL314D1	9.2
UEL314-210D1W3	FL314D1	20
UEL314-211D1W3	FL314D1	
UEL314-212D1W3	FL314D1	
UEL315D1W3	FL315D1	10
UEL315-213D1W3	FL315D1	22
UEL315-214D1W3	FL315D1	
UEL315-215D1W3	FL315D1	
UEL315-300D1W3	FL315D1	
UEL316D1W3	FL316D1	
UEL316-301D1W3	FL316D1	31
UEL316-302D1W3	FL316D1	
UEL316-303D1W3	FL316D1	

## Rhombus flanged unit, cast housing Eccentric locking collar type

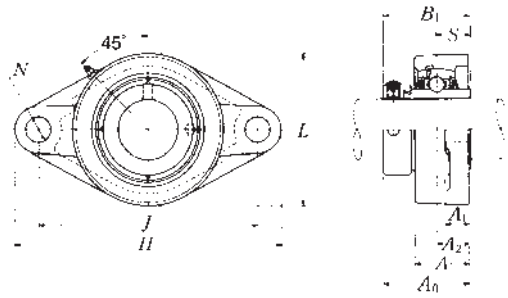

Shaft dia. mm inch	Unit number <sup>(1)</sup> / <sub>(2)</sub>	Nominal dimensions											Bolt size mm inch
		mm inch											
		H	J	A <sub>2</sub>	A <sub>1</sub>	A	N	L	A <sub>0</sub>	B <sub>1</sub>	S	F min.	
85 3 3/4 3 5/16 3 7/16	UELFL317D1W3 UELFL317-304D1W3 UELFL317-305D1W3 UELFL317-306D1W3	370 14 9/16	300 11 13/16	44 1 47/64	32 1 1/4	74 2 29/32	38 1 1/2	220 8 21/32	111.45 4 25/64	109.5 4.311	42.05 1.656	119 4.685	M33 1 1/4
90 3 7/16 3 1/2	UELFL318D1W3 UELFL318-307D1W3 UELFL318-308D1W3	385 15 5/32	315 12 13/32	44 1 47/64	36 1 3/32	76 3	38 1 1/2	235 9 3/4	116.25 4 37/64	115.9 4.563	43.65 1.719	125 4.921	M33 1 1/4
95 3 5/8 3 11/16 3 3/4	UELFL319D1W3 UELFL319-310D1W3 UELFL319-311D1W3 UELFL319-312D1W3	405 15 15/16	330 12 63/64	59 2 21/64	40 1 9/16	94 3 11/16	41 1 39/64	250 9 27/32	142.4 5 39/64	122.3 4.815	38.9 1.531	–	M36 1 3/8
100 3 3/8 3 7/8 3 15/16 4	UELFL320D1W3 UELFL320-313D1W3 UELFL320-314D1W3 UELFL320-315D1W3 UELFL320-400D1W3	440 17 5/16	360 14 11/64	59 2 21/64	40 1 9/16	94 3 11/16	44 1 47/64	270 10 5/8	137.6 5 27/64	128.6 5.063	50 1.969	–	M39 1 1/2
105	UELFL321D1W3	440	360	59	40	94	44	270	150.3	139.7	48.4	–	M39
110	UELFL322D1W3	470	390	60	42	96	44	300	152.1	141.3	49.2	–	M39

Notes <sup>(1)</sup> These numbers indicate relubricatable type. If maintenance free type is needed, please order without suffix "D1".

<sup>(2)</sup> Inner race face does not protrude from the housing face except UELFL305 and UELFL316.

Remarks Please refer to page A21 for size of grease fitting.

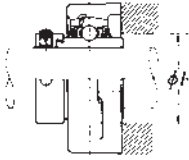

Bearing number	Housing number	Mass of unit
		kg lb
UEL317D1W3	FL317D1	16
UEL317-304D1W3	FL317D1	35
UEL317-305D1W3	FL317D1	
UEL317-306D1W3	FL317D1	
UEL318D1W3	FL318D1	19
UEL318-307D1W3	FL318D1	42
UEL318-308D1W3	FL318D1	
UEL319D1W3	FL319D1	24
UEL319-310D1W3	FL319D1	53
UEL319-311D1W3	FL319D1	
UEL319-312D1W3	FL319D1	
UEL320D1W3	FL320D1	28
UEL320-313D1W3	FL320D1	62
UEL320-314D1W3	FL320D1	
UEL320-315D1W3	FL320D1	
UEL320-400D1W3	FL320D1	
UEL321D1W3	FL321D1	30
UEL322D1W3	FL322D1	36

## Rhombus flanged unit, cast housing Eccentric locking collar type

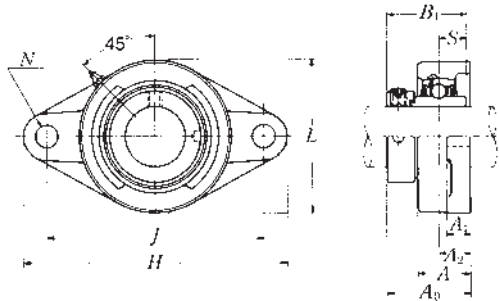

Shaft dia. mm inch	Unit number (1)	Nominal dimensions										Bolt size mm inch
		mm inch										
		H	J	A <sub>2</sub>	A <sub>1</sub>	A	N	L	A <sub>0</sub>	B <sub>1</sub>	S	
20 3/4	UELFLU204D1W3	113	90	19	15	29.5	11.5	61	45.6	43.7	17.1	M10
	UELFLU204-012D1W3	4 7/16	3 35/64	3/4	19/32	1 5/32	29/64	2 13/32	1 51/64	1.720	0.673	5/16
25 13/16 7/8 15/16	UELFLU205D1W3	125	99	19	15	30	11.5	70	45.95	44.4	17.45	M10
	UELFLU205-013D1W3											
	UELFLU205-014D1W3	4 29/32	3 57/64	3/4	19/32	1 3/16	29/64	2 3/4	1 13/16	1.748	0.687	3/8
	UELFLU205-015D1W3											
1	UELFLU205-100D1W3											
30 1 1/16 1 1/8 1 1/4 1 1/4	UELFLU206D1W3	142	116.5	20	16	33	11.5	83	50.15	48.4	18.25	M10
	UELFLU206-101D1W3											
	UELFLU206-102D1W3	5 19/32	4 19/32	25/32	5/8	1 5/16	29/64	3 9/32	1 31/32	1.906	0.719	3/8
	UELFLU206-103D1W3											
	UELFLU206-104D1W3											
35 1 1/4 1 1/16 1 3/8 1 7/16	UELFLU207D1W3	156	130	21	17	36	14	96	53.3	51.1	18.8	M12
	UELFLU207-104D1W3											
	UELFLU207-105D1W3	6 5/32	5 1/8	53/64	2 1/32	1 13/32	35/64	3 25/32	2 3/32	2.012	0.740	1/2
	UELFLU207-106D1W3											
	UELFLU207-107D1W3											
40 1 1/2 1 9/16	UELFLU208D1W3	172	143.5	24	17	39	14	105	58.9	56.3	21.4	M12
	UELFLU208-108D1W3	6 25/32	5 21/32	15/16	2 1/32	1 17/32	35/64	4 1/8	2 5/16	2.217	0.843	1/2
	UELFLU208-109D1W3											
45 1 5/8 1 1/16 1 3/4	UELFLU209D1W3	180	148.5	24	18	40	16	111	58.9	56.3	21.4	M14
	UELFLU209-110D1W3											
	UELFLU209-111D1W3	7 3/32	5 27/32	15/16	23/32	1 9/16	5/8	4 3/8	2 5/16	2.217	0.843	1/2
	UELFLU209-112D1W3											
50 1 13/16 1 7/8 1 15/16 2	UELFLU210D1W3	190	157	28	20	46	18	116	66.1	62.7	24.6	M16
	UELFLU210-113D1W3											
	UELFLU210-114D1W3	7 15/32	6 3/16	1 7/64	25/32	1 13/16	45/64	4 9/16	2 39/64	2.469	0.969	5/8
	UELFLU210-115D1W3											
	UELFLU210-200D1W3											

Note (1) These numbers indicate relubricatable type. If maintenance free type is needed, please order without suffix "D1".

Remarks Please refer to page A21 for size of grease fitting.

Bearing number	Housing number	Mass of unit
		kg lb
UEL204D1W3	FLU204D1	0.6
UEL204-012D1W3	FLU204D1	1.3
UEL205D1W3	FLU205D1	0.7
UEL205-013D1W3	FLU205D1	1.5
UEL205-014D1W3	FLU205D1	
UEL205-015D1W3	FLU205D1	
UEL205-100D1W3	FLU205D1	
UEL206D1W3	FLU206D1	1.1
UEL206-101D1W3	FLU206D1	2.4
UEL206-102D1W3	FLU206D1	
UEL206-103D1W3	FLU206D1	
UEL206-104D1W3	FLU206D1	
UEL207D1W3	FLU207D1	1.5
UEL207-104D1W3	FLU207D1	3.3
UEL207-105D1W3	FLU207D1	
UEL207-106D1W3	FLU207D1	
UEL207-107D1W3	FLU207D1	
UEL208D1W3	FLU208D1	1.9
UEL208-108D1W3	FLU208D1	4.2
UEL208-109D1W3	FLU208D1	
UEL209D1W3	FLU209D1	2.3
UEL209-110D1W3	FLU209D1	5.1
UEL209-111D1W3	FLU209D1	
UEL209-112D1W3	FLU209D1	
UEL210D1W3	FLU210D1	2.9
UEL210-113D1W3	FLU210D1	6.4
UEL210-114D1W3	FLU210D1	
UEL210-115D1W3	FLU210D1	
UEL210-200D1W3	FLU210D1	



## Rhombus flanged unit, cast housing Eccentric locking collar type

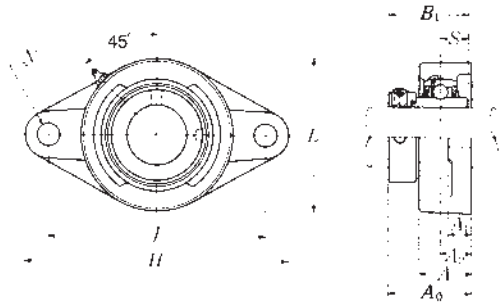

Shaft dia. mm inch	Unit number (1)	Nominal dimensions										Bolt size mm inch
		mm inch										
		H	J	A <sub>2</sub>	A <sub>1</sub>	A	N	L	A <sub>0</sub>	B <sub>1</sub>	S	
55 2 2 1/16 2 5/8 2 3/8 2 7/16	UELFLU211D1W3 UELFLU211-200D1W3 UELFLU211-201D1W3 UELFLU211-202D1W3 UELFLU211-203D1W3	217 8 17/32	184 7 1/4	31 1 1/32	21 1 3/16	49 1 15/16	18 45/64	134 5 9/32	74.65 2 15/16	71.4 2.811	27.75 1.093	M16 5/8
60 2 1/4 2 5/16 2 3/8 2 7/16	UELFLU212D1W3 UELFLU212-204D1W3 UELFLU212-205D1W3 UELFLU212-206D1W3 UELFLU212-207D1W3	235 9 1/4	202 7 61/64	34 1 11/32	21 1 3/16	53 2 3/32	18 45/64	138 5 7/16	80.85 3 3/16	77.8 3.063	30.95 1.219	M16 5/8
65 2 1/2 2 5/16	UELFLU213D1W3 UELFLU213-208D1W3 UELFLU213-209D1W3	248 9 3/4	210 8 17/64	38 1 1/2	22 7/8	59 2 5/16	20.5 1 3/16	152 5 31/32	89.55 3 17/32	85.7 3.374	34.15 1.344	M18 5/8
70 2 5/8 2 1/16 2 3/4	UELFLU214D1W3 UELFLU214-210D1W3 UELFLU214-211D1W3 UELFLU214-212D1W3	257 10 1/8	216 8 1/2	38 1 1/2	22 7/8	62 2 7/16	20.5 1 3/16	159 6 1/4	89.55 3 17/32	85.7 3.374	34.15 1.344	M18 5/8
75 2 3/16 2 7/8 2 3/16 3	UELFLU215D1W3 UELFLU215-213D1W3 UELFLU215-214D1W3 UELFLU215-215D1W3 UELFLU215-300D1W3	266 10 15/32	225 8 55/64	41 1 39/64	22 7/8	65 2 9/16	20.5 1 3/16	165 6 1/2	95.7 3 49/64	92 3.622	37.3 1.469	M18 5/8

Note (1) These numbers indicate relubricatable type. If maintenance free type is needed, please order without suffix "D1".

Remarks Please refer to page A21 for size of grease fitting.

Bearing number	Housing number	Mass of unit
		kg lb
UEL211D1W3	FLU211D1	3.6
UEL211-200D1W3	FLU211D1	7.9
UEL211-201D1W3	FLU211D1	
UEL211-202D1W3	FLU211D1	
UEL211-203D1W3	FLU211D1	
UEL212D1W3	FLU212D1	4.0
UEL212-204D1W3	FLU212D1	8.8
UEL212-205D1W3	FLU212D1	
UEL212-206D1W3	FLU212D1	
UEL212-207D1W3	FLU212D1	
UEL213D1W3	FLU213D1	5.6
UEL213-208D1W3	FLU213D1	12
UEL213-209D1W3	FLU213D1	
UEL214D1W3	FLU214D1	6.3
UEL214-210D1W3	FLU214D1	14
UEL214-211D1W3	FLU214D1	
UEL214-212D1W3	FLU214D1	
UEL215D1W3	FLU215D1	6.8
UEL215-213D1W3	FLU215D1	15
UEL215-214D1W3	FLU215D1	
UEL215-215D1W3	FLU215D1	
UEL215-300D1W3	FLU215D1	

## Light rhombus flanged unit, cast housing Eccentric locking collar type

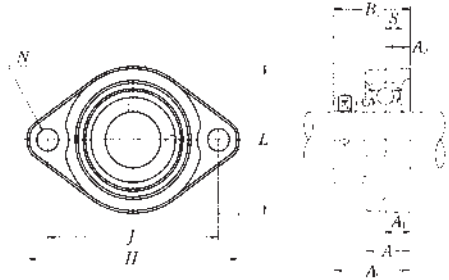

Shaft dia. mm inch	Unit number (*)	Nominal dimensions										Bolt size mm inch
		mm inch										
		H	J	A <sub>2</sub>	A <sub>1</sub>	A	N	L	A <sub>0</sub>	B <sub>1</sub>	S	
12 1/2	AELFB201W3	81	63.5	9.5	9.5	18	7	56	31.6	28.6	6.5	M6
	AELFB201-008W3	3 3/16	2 1/2	3/8	3/8	23/32	9/32	2 7/32	1 1/4	1.126	0.256	1/4
15 9/16 5/8	AELFB202W3	81	63.5	9.5	9.5	18	7	56	31.6	28.6	6.5	M6
	AELFB202-009W3 AELFB202-010W3	3 3/16	2 1/2	3/8	3/8	23/32	9/32	2 7/32	1 1/4	1.126	0.256	1/4
17 1/2	AELFB203W3	81	63.5	9.5	9.5	18	7	56	31.6	28.6	6.5	M6
	AELFB203-011W3	3 3/16	2 1/2	3/8	3/8	23/32	9/32	2 7/32	1 1/4	1.126	0.256	1/4
20 3/4	AELFB204W3	90	71.5	11	11	20	10	61	34.5	31	7.5	M8
	AELFB204-012W3	3 17/32	2 13/16	7/16	7/16	25/32	25/64	2 13/32	1 23/64	1.220	0.295	5/16
25 13/16 7/8 15/16 1	AELFB205W3	95	76	11	11	20	10	64	34.5	31	7.5	M8
	AELFB205-013W3 AELFB205-014W3 AELFB205-015W3 AELFB205-100W3	3 3/4	2 63/64	7/16	7/16	25/32	25/64	2 17/32	1 23/64	1.220	0.295	5/16
30 1 1/16 1 1/8 1 3/16 1 1/4	AELFB206W3	113	90.5	12	12	22.5	12	76	38.7	35.7	9	M10
	AELFB206-101W3 AELFB206-102W3 AELFB206-103W3 AELFB206-104W3	4 7/16	3 9/16	15/32	15/32	7/8	15/32	3	1 17/32	1.406	5415	3/8
35 1 1/4 1 5/16 1 3/8 1 7/16	AELFB207W3	122	100	11	13	24	12	89	40.4	38.9	9.5	M10
	AELFB207-104W3 AELFB207-105W3 AELFB207-106W3 AELFB207-107W3	4 13/16	3 15/16	7/16	1/2	15/16	15/32	3 1/2	1 19/32	1.531	0.374	3/8

Note (\*) If relubricatable type is needed, please order with suffix "D1".

Bearing number	Housing number	Mass of unit
		kg lb
AEL201W3	FB201	0.3
AEL201-008W3	FB201	0.7
AEL202W3	FB201	0.3
AEL202-009W3	FB201	0.7
AEL202-010W3	FB201	
AEL203W3	FB201	0.3
AEL203-011W3	FB201	0.7
AEL204W3	FB204	0.4
AELB204-012W3	FB204	0.9
AEL205W3	FB205	0.4
AEL205-013W3	FB205	
AEL205-014W3	FB205	0.9
AEL205-015W3	FB205	
AEL205-100W3	FB205	
AEL206W3	FB206	0.6
AEL206-101W3	FB206	
AEL206-102W3	FB206	1.3
AEL206-103W3	FB206	
AEL206-104W3	FB206	
AEL207W3	FB207	0.9
AEL207-104W3	FB207	
AEL207-105W3	FB207	2.0
AEL207-106W3	FB207	
AEL207-107W3	FB207	

## Light rhombus flanged unit, cast housing Eccentric locking collar type

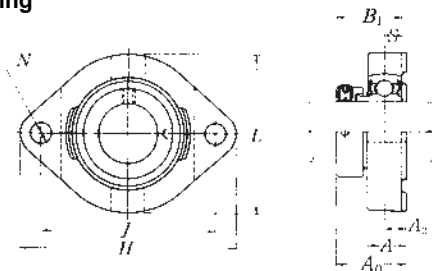

Shaft dia.  mm inch	Unit number (1)	Nominal dimensions									Bolt size  mm inch
		mm inch									
		H	J	A <sub>2</sub>	A	N	L	A <sub>0</sub>	B <sub>1</sub>	S	
12  1/2	AELFD201W3	81	63	8.5	15	7	59	30.6	28.6	6.5	M6
	AELFD201-008W3	3 3/16	2 31/64	21/64	19/32	9/32	2 5/16	1 13/64	1.126	0.256	1/4
15  9/16 5/8	AELFD202W3	81	63	8.5	15	7	59	30.6	28.6	6.5	M6
	AELFD202-009W3 AELFD202-010W3	3 3/16	2 31/64	21/64	19/32	9/32	2 5/16	1 13/64	1.126	0.256	1/4
17  11/16	AELFD203W3	81	63	8.5	15	7	59	30.6	28.6	6.5	M6
	AELFD203-011W3	3 3/16	2 31/64	21/64	19/32	9/32	2 5/16	1 13/64	1.126	0.256	1/4
20  3/4	AELFD204W3	90	71	9.5	17	10	67	33	31	7.5	M8
	AELFD204-012W3	3 17/32	2 51/64	3/8	2 1/32	25/64	2 5/8	1 13/64	1.220	0.295	5/16
25  13/16 7/8 15/16 1	AELFD205W3	95	76	9.5	17	10	71	33	31	7.5	M8
	AELFD205-013W3										
	AELFD205-014W3	3 3/4	2 63/64	3/8	2 1/32	25/64	2 25/32	1 19/64	1.220	0.295	5/16
	AELFD205-015W3 AELFD205-100W3										
30  1 1/16 1 1/8 1 3/16 1 1/4	AELFD206W3	113	90	12	21	12	84	38.7	35.7	9	M10
	AELFD206-101W3										
	AELFD206-102W3	4 7/16	3 35/64	15/32	1 3/16	15/32	3 5/16	1 17/32	1.406	0.354	3/8
	AELFD206-103W3 AELFD206-104W3										
35  1 1/4 1 5/16 1 3/8 1 7/16	AELFD207W3	125	100	12.5	22	12	94	41.9	38.9	9.5	M10
	AELFD207-104W3										
	AELFD207-105W3	4 29/32	3 15/16	31/64	7/8	15/32	3 11/16	1 21/32	1.531	0.374	3/8
	AELFD207-106W3 AELFD207-107W3										
40  1 1/2 1 7/16	AELFD208W3	148	119	14.5	25	13.5	104	47.2	43.7	11	M12
	AELFD208-108W3										
	AELFD208-109W3	5 13/16	4 11/16	37/64	31/32	17/32	4 3/32	1 27/32	1.720	0.433	7/16

Note (1) If relubricatable type is needed, please order with suffix "A-" "D1". Example: A-AELFD201D1W3

Bearing number	Housing number	Mass of unit
		kg lb
AEL201W3	FD201	0.3
AEL201-008W3	FD201	0.7
AEL202W3	FD201	0.3
AEL202-009W3	FD201	0.7
AEL202-010W3	FD201	
AEL203W3	FD201	0.3
AEL203-011W3	FD201	0.7
AEL204W3	FD204	0.4
AEL204-012W3	FD204	0.9
AEL205W3	FD205	0.5
AEL205-013W3	FD205	1.1
AEL205-014W3	FD205	
AEL205-015W3	FD205	
AEL205-100W3	FD205	
AEL206W3	FD206	0.8
AEL206-101W3	FD206	1.8
AEL206-102W3	FD206	
AEL206-103W3	FD206	
AEL206-104W3	FD206	
AEL207W3	FD207	1.1
AEL207-104W3	FD207	2.4
AEL207-105W3	FD207	
AEL207-106W3	FD207	
AEL207-107W3	FD207	
AEL208W3	FD208	1.5
AEL208-108W3	FD208	3.3
AEL208-109W3	FD208	

## Light rhombus flanged unit, cast housing Eccentric locking collar type

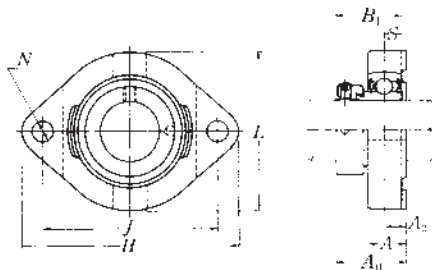

Shaft dia.  mm inch	Unit number (1)	Nominal dimensions									Bolt size  mm inch
		mm inch									
		H	J	A <sub>2</sub>	A	N	L	A <sub>0</sub>	B <sub>1</sub>	S	
12 1/2	JELFD201W3	81	63	8.5	15	7	59	30.6	28.6	6.5	M6
	JELFD201-008W3	3 3/16	2 31/64	21/64	19/32	9/32	2 5/16	1 13/64	1.126	0.256	1/4
15 9/16 5/8	JELFD202W3	81	63	8.5	15	7	59	30.6	28.6	6.5	M6
	JELFD202-009W3 JELFD202-010W3	3 3/16	2 31/64	21/64	19/32	9/32	2 5/16	1 13/64	1.126	0.256	1/4
17 11/16	JELFD203W3	81	63	8.5	15	7	59	30.6	28.6	6.5	M6
	JELFD203-011W3	3 3/16	2 31/64	21/64	19/32	9/32	2 5/16	1 13/64	1.126	0.256	1/4
20 3/4	JELFD204W3	90	71	9.5	17	10	67	33	31	7.5	M8
	JELFD204-012W3	3 17/32	2 51/64	3/8	2 1/32	25/64	2 5/8	1 19/64	1.220	0.295	5/16
25 13/16 7/8 15/16 1	JELFD205W3	95	76	9.5	17	10	71	33	31	7.5	M8
	JELFD205-013W3 JELFD205-014W3 JELFD205-015W3	3 3/4	2 63/64	3/8	2 1/32	25/64	2 25/32	1 19/64	1.220	0.295	5/16
	JELFD205-100W3										
30 1 1/16 1 1/8 1 3/16 1 1/4	JELFD206W3	113	90	12	21	12	84	38.7	35.7	9	M10
	JELFD206-101W3 JELFD206-102W3 JELFD206-103W3 JELFD206-104W3	4 7/16	3 35/64	15/32	1 3/16	1 5/32	3 5/16	1 17/32	1.406	0.354	3/8
35 1 1/4 1 5/16 1 3/8 1 7/16	JELFD207W3	125	100	12.5	22	12	94	41.9	38.9	9.5	M10
	JELFD207-104W3 JELFD207-105W3 JELFD207-106W3 JELFD207-107W3	4 29/32	3 15/16	31/64	7/8	1 5/32	3 11/16	1 21/32	1.531	0.374	3/8
40 1 1/2 1 9/16	JELFD208W3	148	119	14.5	25	13.5	104	47.2	43.7	11	M12
	JELFD208-108W3 JELFD208-109W3	5 13/16	4 11/16	37/64	3 1/32	1 7/32	4 3/32	1 27/32	1.720	0.433	7/16

Note (1) If relubricatable type is needed, please order with suffix "A-" "D1". Example:A-JELFD201D1W3

Bearing number	Housing number	Mass of unit
		kg lb
JEL201W3	FD201	0.3
JEL201-008W3	FD201	0.7
JEL202W3	FD201	0.3
JEL202-009W3	FD201	0.7
JEL202-010W3	FD201	
JEL203W3	FD201	0.3
JEL203-011W3	FD201	0.7
AEL204W3	FD204	0.4
JEL204-012W3	FD204	0.9
JEL205W3	FD205	0.5
JEL205-013W3	FD205	1.1
JEL205-014W3	FD205	
JEL205-015W3	FD205	
JEL205-100W3	FD205	
JEL206W3	FD206	0.8
JEL206-101W3	FD206	1.8
JEL206-102W3	FD206	
JEL206-103W3	FD206	
JEL206-104W3	FD206	
JEL207W3	FD207	1.1
JEL207-104W3	FD207	2.4
JEL207-105W3	FD207	
JEL207-106W3	FD207	
JEL207-107W3	FD207	
JEL208W3	FD208	1.5
JEL208-108W3	FD208	3.3
JEL208-109W3	FD208	



## Round flanged unit, pressed steel housing Eccentric locking collar type

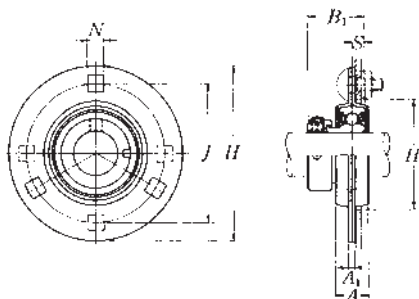

Shaft dia.  mm inch	Unit number	Nominal dimensions								Bolt size  mm inch
		<i>H</i>	<i>J</i>	<i>A</i> <sub>1</sub>	<i>M</i> <sup>(1)</sup>	<i>A</i>	<i>B</i> <sub>1</sub>	<i>S</i>	<i>H</i> <sub>1</sub> min.	
12 1/2	<b>AELPF201W3</b>	81	63.5	4	7.1	14	28.6	6.5	49	M6
	<b>AELPF201-008W3</b>	3 3/16	2 1/2	0.157	9/32	9/16	1.126	0.256	1 15/16	1/4
15 9/16 5/8	<b>AELPF202W3</b>	81	63.5	4	7.1	14	28.6	6.5	49	M6
	<b>AELPF202-009W3</b>	3 3/16	2 1/2	0.157	9/32	9/16	1.126	0.256	1 15/16	1/4
	<b>AELPF202-010W3</b>									
17 1 1/16	<b>AELPF203W3</b>	81	63.5	4	7.1	14	28.6	6.5	49	M6
	<b>AELPF203-011W3</b>	3 3/16	2 1/2	0.157	9/32	9/16	1.126	0.256	1 15/16	1/4
20 3/4	<b>AELPF204W3</b>	90	71.5	4	9	16	31	7.5	56	M8
	<b>AELPF204-012W3</b>	3 35/64	2 13/16	0.157	23/64	5/8	1.220	0.295	2 7/32	5/16
25 1 3/16 7/8 15/16 1	<b>AELPF205W3</b>	95	76	4	9	18	31	7.5	60	M8
	<b>AELPF205-013W3</b>									
	<b>AELPF205-014W3</b>	3 3/4	2 63/64	0.157	23/64	23/32	1.220	0.295	2 3/8	5/16
	<b>AELPF205-015W3</b>									
30 1 1/16 1 1/8 1 1/16 1 1/4	<b>AELPF206W3</b>	113	90.5	5.2	11	18	35.7	9	71	M10
	<b>AELPF206-101W3</b>									
	<b>AELPF206-102W3</b>	4 7/16	3 9/16	0.205	7/16	23/32	1.406	0.354	2 19/16	3/8
	<b>AELPF206-104W3</b>									
35 1 1/4 1 5/16 1 3/8 1 1/16	<b>AELPF207W3</b>	122	100	5.2	11	20	38.9	9.5	81	M10
	<b>AELPF207-104W3</b>									
	<b>AELPF207-105W3</b>	4 13/16	3 15/16	0.205	7/16	25/32	1.531	0.374	3 3/16	3/8
	<b>AELPF207-107W3</b>									
40 1 1/2 1 5/8	<b>AELPF208W3</b>	148	119	6.8	13.5	21	43.7	11	91	M12
	<b>AELPF208-108W3</b>	5 13/16	4 1/16	0.268	17/32	13/16	1.720	0.433	3 19/32	1/2
	<b>AELPF208-109W3</b>									

Notes (1) AELPF208 has four bolt holes.

(2) The permissible load only applies in applications where the load is stable and the speed is 2400 min<sup>-1</sup> or less.

Max. load (°)		Bearing number	Housing number	Mass of unit
recommended				
N lbf				kg lb
radial	axial			
2 700	1 350	AEL201W3	PF203	0.3
600	300	AEL201-008W3	PF203	0.7
2 700	1 350	AEL202W3	PF203	0.3
600	300	AEL202-009W3	PF203	0.7
		AEL202-010W3	PF203	
2 700	1 350	AEL203W3	PF203	0.3
600	300	AEL203-011W3	PF203	0.7
3 000	1 500	AEL204W3	PF204	0.3
660	330	AEL204-012W3	PF204	0.7
4 000	2 000	AEL205W3	PF205	0.4
		AEL205-013W3	PF205	
880	440	AEL205-014W3	PF205	0.9
		AEL205-015W3	PF205	
		AEL205-100W3	PF205	
5 000	2 500	AEL206W3	PF206	0.6
		AEL206-101W3	PF206	
1 100	550	AEL206-102W3	PF206	1.3
		AEL206-103W3	PF206	
		AEL206-104W3	PF206	
6 000	3 000	AEL207W3	PF207	0.8
		AEL207-104W3	PF207	
1 300	650	AEL207-105W3	PF207	1.8
		AEL207-106W3	PF207	
		AEL207-107W3	PF207	
7 000	3 500	AEL208W3	PF208	1.4
		AEL208-108W3	PF208	
1 500	750	AEL208-109W3	PF208	3.1

## Round flanged unit, pressed steel housing Eccentric locking collar type

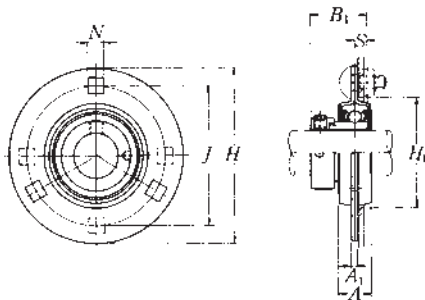

Shaft dia. mm inch	Unit number	Nominal dimensions								Bolt size mm inch
		<i>H</i>	<i>J</i>	<i>A</i> <sub>1</sub>	<i>N</i> <sup>(1)</sup> mm	<i>A</i> inch	<i>B</i> <sub>1</sub>	<i>S</i>	<i>H</i> <sub>1</sub> min.	
12 ½	JELPF201W3	81	63.5	4	7.1	14	28.6	6.5	49	M6
	JELPF201-008W3	3 <sup>3</sup> / <sub>16</sub>	2 <sup>1</sup> / <sub>2</sub>	0.157	<sup>9</sup> / <sub>32</sub>	<sup>9</sup> / <sub>16</sub>	1.126	0.256	1 <sup>15</sup> / <sub>16</sub>	<sup>1</sup> / <sub>4</sub>
15 <sup>9</sup> / <sub>16</sub> <sup>5</sup> / <sub>8</sub>	JELPF202W3	81	63.5	4	7.1	14	28.6	6.5	49	M6
	JELPF202-009W3 JELPF202-010W3	3 <sup>3</sup> / <sub>16</sub>	2 <sup>1</sup> / <sub>2</sub>	0.157	<sup>9</sup> / <sub>32</sub>	<sup>9</sup> / <sub>16</sub>	1.126	0.256	1 <sup>15</sup> / <sub>16</sub>	<sup>1</sup> / <sub>4</sub>
17 <sup>11</sup> / <sub>16</sub>	JELPF203W3	81	63.5	4	7.1	14	28.6	6.5	49	M6
	JELPF203-011W3	3 <sup>3</sup> / <sub>16</sub>	2 <sup>1</sup> / <sub>2</sub>	0.157	<sup>9</sup> / <sub>32</sub>	<sup>9</sup> / <sub>16</sub>	1.126	0.256	1 <sup>15</sup> / <sub>16</sub>	<sup>1</sup> / <sub>4</sub>
20 ¾	JELPF204W3	90	71.5	4	9	16	31	7.5	56	M8
	JELPF204-012W3	3 <sup>35</sup> / <sub>64</sub>	2 <sup>13</sup> / <sub>16</sub>	0.157	<sup>23</sup> / <sub>64</sub>	<sup>5</sup> / <sub>8</sub>	1.220	0.295	2 <sup>7</sup> / <sub>32</sub>	<sup>5</sup> / <sub>16</sub>
25 <sup>13</sup> / <sub>16</sub> <sup>7</sup> / <sub>8</sub> <sup>15</sup> / <sub>16</sub> 1	JELPF205W3	95	76	4	9	18	31	7.5	60	M8
	JELPF205-013W3	3 <sup>3</sup> / <sub>4</sub>	2 <sup>63</sup> / <sub>64</sub>	0.157	<sup>23</sup> / <sub>64</sub>	<sup>23</sup> / <sub>32</sub>	1.220	0.295	2 <sup>3</sup> / <sub>8</sub>	<sup>5</sup> / <sub>16</sub>
	JELPF205-014W3									
	JELPF205-015W3									
JELPF205-100W3										
30 1 <sup>1</sup> / <sub>16</sub> 1 <sup>1</sup> / <sub>8</sub> 1 <sup>1</sup> / <sub>4</sub> 1 <sup>1</sup> / <sub>4</sub>	JELPF206W3	113	90.5	5.2	11	18	35.7	9	71	M10
	JELPF206-101W3	4 <sup>7</sup> / <sub>16</sub>	3 <sup>9</sup> / <sub>16</sub>	0.205	<sup>7</sup> / <sub>16</sub>	<sup>23</sup> / <sub>32</sub>	1.406	0.354	2 <sup>19</sup> / <sub>16</sub>	<sup>3</sup> / <sub>8</sub>
	JELPF206-102W3									
	JELPF206-103W3									
JELPF206-104W3										
35 1 <sup>1</sup> / <sub>4</sub> 1 <sup>1</sup> / <sub>16</sub> 1 <sup>3</sup> / <sub>8</sub> 1 <sup>1</sup> / <sub>16</sub>	JELPF207W3	122	100	5.2	11	20	38.9	9.5	81	M10
	JELPF207-104W3	4 <sup>13</sup> / <sub>16</sub>	3 <sup>15</sup> / <sub>16</sub>	0.205	<sup>7</sup> / <sub>16</sub>	<sup>25</sup> / <sub>32</sub>	1.531	0.374	3 <sup>3</sup> / <sub>16</sub>	<sup>3</sup> / <sub>8</sub>
	JELPF207-105W3									
	JELPF207-106W3									
JELPF207-107W3										
40 1 <sup>1</sup> / <sub>2</sub> 1 <sup>1</sup> / <sub>16</sub>	JELPF208W3	148	119	6.8	13.5	21	43.7	11.0	91	M12
	JELPF208-108W3 JELPF208-109W3	5 <sup>13</sup> / <sub>16</sub>	4 <sup>1</sup> / <sub>16</sub>	0.268	<sup>17</sup> / <sub>32</sub>	<sup>13</sup> / <sub>16</sub>	1.720	0.433	3 <sup>19</sup> / <sub>32</sub>	<sup>1</sup> / <sub>2</sub>

Notes (1) JELPF208 has four bolt holes.

(2) The permissible load only applies in applications where the load is stable and the speed is 2400 min<sup>-1</sup> or less.

<b>Max. load (°)</b> <b>recommended</b>		<b>Bearing number</b>	<b>Housing number</b>	<b>Mass of unit</b>	
<b>N lbf</b>				<b>kg</b>	<b>lb</b>
radial	axial				
2 700	1 350	JEL201W3	PF203	0.3	
600	300	JEL201-008W3	PF203	0.7	
2 700	1 350	JEL202W3	PF203	0.3	
600	300	JEL202-009W3	PF203	0.7	
		JEL202-010W3	PF203		
2 700	1 350	JEL203W3	PF203	0.3	
600	300	JEL203-011W3	PF203	0.7	
3 000	1 500	JEL204W3	PF204	0.3	
660	330	JEL204-012W3	PF204	0.7	
4 000	2 000	JEL205W3	PF205	0.4	
		JEL205-013W3	PF205		
880	440	JEL205-014W3	PF205	0.9	
		JEL205-015W3	PF205		
		JEL205-100W3	PF205		
5 000	2 500	JEL206W3	PF206	0.6	
		JEL206-101W3	PF206		
1 100	550	JEL206-102W3	PF206	1.3	
		JEL206-103W3	PF206		
		JEL206-104W3	PF206		
6 000	3 000	JEL207W3	PF207	0.8	
		JEL207-104W3	PF207		
1 300	650	JEL207-105W3	PF207	1.8	
		JEL207-106W3	PF207		
		JEL207-107W3	PF207		
7 000	3 500	JEL208W3	PF208	1.4	
		JEL208-108W3	PF208	3.1	
1 500	750	JEL208-109W3	PF208		

# AELRPF2

Round flanged unit, pressed steel housing with rubber ring  
Eccentric locking collar type

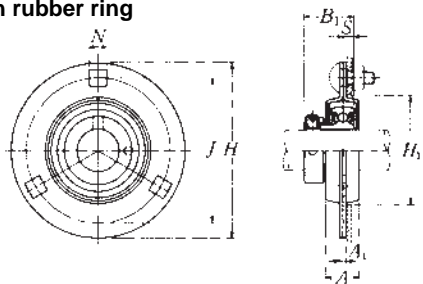

Shaft dia.	Unit number	Nominal dimensions									Bolt size
		<i>H</i>	<i>J</i>	<i>A</i> <sub>1</sub>	<i>N</i>	<i>A</i>	<i>B</i> <sub>1</sub>	<i>S</i>	<i>H</i> <sub>1</sub> min.	<i>mm</i> <i>inch</i>	
12 1/2	<b>AELRPF201W3</b> <b>AELRPF201-008W3</b>	90 3 <sup>35</sup> / <sub>64</sub>	71.5 2 <sup>13</sup> / <sub>16</sub>	4 0.157	9 2 <sup>23</sup> / <sub>64</sub>	16 5/ <sub>8</sub>	28.6 1.126	6.5 0.256	56 2 <sup>7</sup> / <sub>32</sub>	M8 5/ <sub>16</sub>	
15 9 16 5 8	<b>AELRPF202W3</b> <b>AELRPF202-009W3</b> <b>AELRPF202-010W3</b>	90 3 <sup>35</sup> / <sub>64</sub>	71.5 2 <sup>13</sup> / <sub>16</sub>	4 0.157	9 2 <sup>23</sup> / <sub>64</sub>	16 5/ <sub>8</sub>	28.6 1.126	6.5 0.256	56 2 <sup>7</sup> / <sub>32</sub>	M8 5/ <sub>16</sub>	
17 11 16	<b>AELRPF203W3</b> <b>AELRPF203-011W3</b>	90 3 <sup>35</sup> / <sub>64</sub>	71.5 2 <sup>13</sup> / <sub>16</sub>	4 0.157	9 2 <sup>23</sup> / <sub>64</sub>	16 5/ <sub>8</sub>	28.6 1.126	6.5 0.256	56 2 <sup>7</sup> / <sub>32</sub>	M8 5/ <sub>16</sub>	
20 3 4	<b>AELRPF204W3</b> <b>AELRPF204-012W3</b>	95 3 <sup>3</sup> / <sub>4</sub>	76 2 <sup>63</sup> / <sub>64</sub>	4 0.157	9 2 <sup>23</sup> / <sub>64</sub>	18 2 <sup>23</sup> / <sub>32</sub>	31 1.220	7.5 0.295	60 2 <sup>3</sup> / <sub>8</sub>	M8 5/ <sub>16</sub>	
25 13 16 7 8 15 16 1	<b>AELRPF205W3</b> <b>AELRPF205-013W3</b> <b>AELRPF205-014W3</b> <b>AELRPF205-015W3</b> <b>AELRPF205-100W3</b>	113 4 <sup>7</sup> / <sub>16</sub>	90.5 3 <sup>3</sup> / <sub>16</sub>	5.2 0.205	11 7/ <sub>16</sub>	18 2 <sup>23</sup> / <sub>32</sub>	31 1.220	7.5 0.295	71 2 <sup>19</sup> / <sub>16</sub>	M10 3/ <sub>8</sub>	
30 1 16 1 8 1 8 1 4	<b>AELRPF206W3</b> <b>AELRPF206-101W3</b> <b>AELRPF206-102W3</b> <b>AELRPF206-103W3</b> <b>AELRPF206-104W3</b>	122 4 <sup>13</sup> / <sub>16</sub>	100 3 <sup>5</sup> / <sub>16</sub>	5.2 0.205	11 7/ <sub>16</sub>	20 2 <sup>25</sup> / <sub>32</sub>	35.7 1.406	9 0.354	81 3 <sup>3</sup> / <sub>16</sub>	M10 3/ <sub>8</sub>	

**Note** (1) The permissible load only applies in applications where the load is stable and the speed is 2400 min<sup>-1</sup> or less.

**Remarks** When an anti-vibration rubber ring is used, the self alignment capability will be reduce.

Max. load (1)		Bearing number	Housing number		Mass of unit
N lbf			rubber ring	steel	
radial	axial				
1 000	200	AEL201W3	R201	PF204	0.3
220	40	AEL201-008W3	R201	PF204	0.7
1 000	200	AEL202W3	R201	PF204	0.3
220	40	AEL202-009W3	R201	PF204	0.7
		AEL202-010W3	R201	PF204	0.7
1 000	200	AEL203W3	R201	PF204	0.3
220	40	AEL203-011W3	R201	PF204	0.7
1 150	200	AEL204W3	R204	PF205	0.4
250	40	AEL204-012W3	R204	PF205	0.9
1 300	200	AEL205W3	R205	PF206	0.5
		AEL205-013W3	R205	PF206	
		AEL205-014W3	R205	PF206	
280	40	AEL205-015W3	R205	PF206	1.1
		AEL205-100W3	R205	PF206	
1 500	200	AEL206W3	R206	PF207	0.7
		AEL206-101W3	R206	PF207	
		AEL206-102W3	R206	PF207	
330	40	AEL206-103W3	R206	PF207	1.5
		AEL206-104W3	R206	PF207	

# AELPFL2

## Rhombus flanged unit, pressed steel housing Eccentric locking collar type

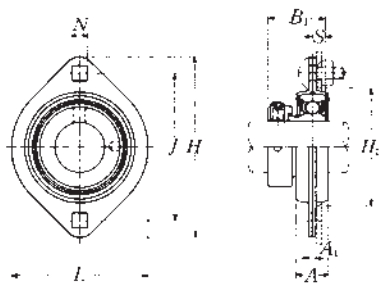

Shaft dia.  mm inch	Unit number	Nominal dimensions									Bolt size  mm inch
		mm inch									
		H	J	A <sub>1</sub>	N	A	L	B <sub>1</sub>	S	H <sub>1</sub>	
12 1/2	AELPFL201W3	81	63.5	4	7.1	14	59	28.6	6.5	49	M6
	AELPFL201-008W3	3 3/16	2 1/2	0.157	9/32	9/16	2 5/16	1.126	0.256	1 15/16	1/4
15 9/16 5/8	AELPFL202W3	81	63.5	4	7.1	14	59	28.6	6.5	49	M6
	AELPFL202-009W3 AELPFL202-010W3	3 3/16	2 1/2	0.157	9/32	9/16	2 5/16	1.126	0.256	1 15/16	1/4
17 1 1/16	AELPFL203W3	81	63.5	4	7.1	14	59	28.6	6.5	49	M6
	AELPFL203-011W3	3 3/16	2 1/2	0.157	9/32	9/16	2 5/16	1.126	0.256	1 15/16	1/4
20 3/4	AELPFL204W3	90	71.5	4	9	16	67	31	7.5	56	M8
	AELPFL204-012W3	3 35/64	2 13/16	0.157	23/64	5/8	2 5/8	1.220	0.295	2 7/32	5/16
25 1 3/16 7/8 15/16 1	AELPFL205W3	95	76	4	9	18	71	31	7.5	60	M8
	AELPFL205-013W3										
	AELPFL205-014W3	3 3/4	2 63/64	0.157	23/64	23/32	2 25/32	1.220	0.295	2 3/8	5/16
	AELPFL205-015W3 AELPFL205-100W3										
30 1 1/16 1 1/8 1 3/16 1 1/4	AELPFL206W3	113	90.5	5.2	11	18	84	35.7	9	71	M10
	AELPFL206-101W3										
	AELPFL206-102W3	4 7/16	3 3/16	0.205	7/16	23/32	3 3/16	1.406	0.354	2 19/16	3/8
	AELPFL206-103W3 AELPFL206-104W3										
35 1 1/4 1 5/16 1 3/8 1 7/16	AELPFL207W3	122	100	5.2	11	20	94	38.9	9.5	81	M10
	AELPFL207-104W3										
	AELPFL207-105W3	4 13/16	3 15/16	0.205	7/16	25/32	3 11/16	1.531	0.374	3 3/16	3/8
	AELPFL207-106W3 AELPFL207-107W3										
40 1 1/2 1 5/8	AELPFL208W3	148	119	6.8	13.5	21	100	43.7	11	91	M12
	AELPFL208-108W3 AELPFL208-109W3	5 13/16	4 11/16	0.268	17/32	13/16	3 15/16	1.720	0.433	3 19/32	1/2

Note (!) The permissible load only applies in applications where the load is stable and the speed is 2400 min<sup>-1</sup> or less.

Max. load (1)		Bearing number	Housing number	Mass of unit
recommended				
N lbf				kg lb
radial	axial			
2 700	1 350	AEL201W3	PFL203W3	0.3
600	300	AEL201-008W3	PFL203W3	0.7
2 700	1 350	AEL202W3	PFL203W3	0.3
600	300	AEL202-009W3	PFL203W3	0.7
		AEL202-010W3	PFL203W3	
2 700	1 350	AEL203W3	PFL203W3	0.3
600	300	AEL203-011W3	PFL203W3	0.7
3 000	1 500	AEL204W3	PFL204W3	0.3
660	330	AEL204-012W3	PFL204W3	0.7
4 000	2 000	AEL205W3	PFL205W3	0.4
880	440	AEL205-013W3	PFL205W3	0.9
		AEL205-014W3	PFL205W3	
		AEL205-015W3	PFL205W3	
		AEL205-100W3	PFL205W3	
5 000	2 500	AEL206W3	PFL206W3	0.6
1 100	550	AEL206-101W3	PFL206W3	1.3
		AEL206-102W3	PFL206W3	
		AEL206-103W3	PFL206W3	
		AEL206-104W3	PFL206W3	
6 000	3 000	AEL207W3	PFL207W3	0.9
1 300	650	AEL207-104W3	PFL207W3	2.0
		AEL207-105W3	PFL207W3	
		AEL207-106W3	PFL207W3	
		AEL207-107W3	PFL207W3	
6 000	3 000	AEL208W3	PFL208W3	1.3
1 300	650	AEL208-108W3	PFL208W3	2.9
		AEL208-109W3	PFL208W3	



## Rhombus flanged unit, pressed steel housing Eccentric locking collar type

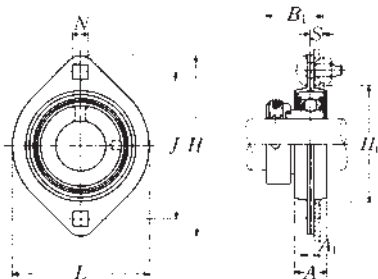

Shaft dia. mm inch	Unit number	Nominal dimensions									Bolt size mm inch
		mm inch									
		H	J	A <sub>1</sub>	N	A	L	B <sub>1</sub>	S	H <sub>1</sub>	
12 1/2	JELPFL201W3	81	63	4	7.1	14	59	28.6	6.5	49	M6
	JELPFL201-008W3	3 3/16	2 31/64	0.157	9/32	9/16	2 5/16	1.126	0.256	1 15/16	1/4
15 9/16 5/8	JELPFL202W3	81	63	4	7.1	14	59	28.6	6.5	49	M6
	JELPFL202-009W3 JELPFL202-010W3	3 3/16	2 31/64	0.157	9/32	9/16	2 5/16	1.126	0.256	1 15/16	1/4
17 1 1/16	JELPFL203W3	81	63	4	7.1	14	59	28.6	6.5	49	M6
	JELPFL203-011W3	3 3/16	2 31/64	0.157	9/32	9/16	2 5/16	1.126	0.256	1 15/16	1/4
20 3/4	JELPFL204W3	90	71	4	9	16	67	31	7.5	56	M8
	JELPFL204-012W3	3 35/64	2 51/64	0.157	23/64	5/8	2 5/8	1.220	0.295	2 7/32	5/16
25 1 3/16 7/8 15/16 1	JELPFL205W3	95	76	4	9	18	71	31	7.5	60	M8
	JELPFL205-013W3										
	JELPFL205-014W3	3 3/4	2 63/64	0.157	23/64	23/32	2 25/32	1.220	0.295	2 3/8	5/16
	JELPFL205-015W3 JELPFL205-100W3										
30 1 1/16 1 1/8 1 3/16 1 1/4	JELPFL206W3	113	90	5.2	11	18	84	35.7	9	71	M10
	JELPFL206-101W3										
	JELPFL206-102W3	4 7/16	3 35/64	0.205	7/16	23/32	3 3/16	1.406	0.354	2 9/16	3/8
	JELPFL206-103W3 JELPFL206-104W3										
35 1 1/4 1 5/16 1 3/8 1 1/2	JELPFL207W3	122	100	5.2	11	20	94	38.9	9.5	81	M10
	JELPFL207-104W3										
	JELPFL207-105W3	4 13/16	3 15/16	0.205	7/16	25/32	3 11/16	1.531	0.374	3 3/16	3/8
	JELPFL207-106W3 JELPFL207-107W3										
40 1 1/2 1 5/8	JELPFL208W3	148	119	6.8	13.5	21	100	43.7	11	91	M12
	JELPFL208-108W3 JELPFL208-109W3	5 13/16	4 11/16	0.268	17/32	13/16	3 15/16	1.720	0.433	3 19/32	1/2

Note (1) The permissible load only applies in applications where the load is stable and the speed is 2400 min<sup>-1</sup> or less.

Max. load (1)		Bearing number	Housing number	Mass of unit
recommended				
N lbf				kg lb
radial	axial			
2 700	1 350	JEL201W3	PFL203W3	0.3
600	300	JEL201-008W3	PFL203W3	0.7
2 700	1 350	JEL202W3	PFL203W3	0.3
600	300	JEL202-009W3	PFL203W3	0.7
		JEL202-010W3	PFL203W3	
2 700	1 350	JEL203W3	PFL203W3	0.3
600	300	JEL203-011W3	PFL203W3	0.7
3 000	1 500	JEL204W3	PFL204W3	0.3
660	330	JEL204-012W3	PFL204W3	0.7
4 000	2 000	JEL205W3	PFL205W3	0.4
		JEL205-013W3	PFL205W3	
		JEL205-014W3	PFL205W3	
880	440	JEL205-015W3	PFL205W3	0.9
		JEL205-100W3	PFL205W3	
5 000	2 500	JEL206W3	PFL206W3	0.6
		JEL206-101W3	PFL206W3	
		JEL206-102W3	PFL206W3	
1 100	550	JEL206-103W3	PFL206W3	1.3
		JEL206-104W3	PFL206W3	
6 000	3 000	JEL207W3	PFL207W3	0.9
		JEL207-104W3	PFL207W3	
		JEL207-105W3	PFL207W3	
1 300	650	JEL207-106W3	PFL207W3	2.0
		JEL207-107W3	PFL207W3	
6 000	3 000	JEL208W3	PFL208W3	1.3
		JEL208-108W3	PFL208W3	
1 300	650	JEL208-109W3	PFL208W3	2.9

## Take-up unit, cast housing Eccentric locking collar type

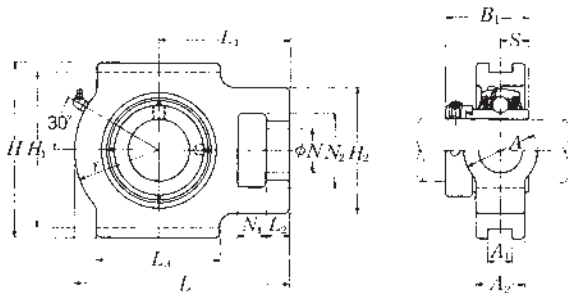

Shaft dia. mm inch	Unit number (1)	Nominal dimensions											
		mm inch											
		$N_1$	$L_2$	$H_2$	$N_2$	$N$	$L_3$	$A_1$	$H_1$	$H$	$L$	$A_2$	$A$
20 3/4	UELT204D1W3	16	12	51	32	19	51	12	76	89	94	21	32
	UELT204-012D1W3	5/8	15/32	2	1 1/4	3/4	2	0.472	2 63/64	3 1/2	3 11/16	13/16	1 1/4
25 13/16 7/8 15/16 1	UELT205D1W3	16	12	51	32	19	51	12	76	89	97	24	32
	UELT205-013D1W3												
	UELT205-014D1W3												
	UELT205-015D1W3	5/8	15/32	2	1 1/4	3/4	2	0.472	2 63/64	3 1/2	3 13/16	15/16	1 1/4
	UELT205-100D1W3												
30 1 1/16 1 1/8 1 3/16 1 1/4	UELT206D1W3	16	12	56	37	22	57	12	89	102	113	28	37
	UELT206-101D1W3												
	UELT206-102D1W3												
	UELT206-103D1W3	5/8	15/32	2 7/32	1 15/32	7/8	2 1/4	0.472	3 1/2	4 7/32	4 7/16	1 3/32	1 15/32
	UELT206-104D1W3												
35 1 1/4 1 5/16 1 3/8 1 7/16	UELT207D1W3	16	15	64	37	22	64	12	89	102	129	30	37
	UELT207-104D1W3												
	UELT207-105D1W3												
	UELT207-106D1W3	5/8	19/32	2 17/32	1 15/32	7/8	2 17/32	0.472	3 1/2	4 1/2	5 3/32	1 3/16	1 15/32
	UELT207-107D1W3												
40 1 1/2 1 9/16	UELT208D1W3	19	18	83	49	29	83	16	102	114	144	33	49
	UELT208-108D1W3												
	UELT208-109D1W3	3/4	23/32	3 3/32	1 15/16	1 5/32	3 9/32	0.630	4 1/64	4 1/2	5 21/32	1 5/16	1 15/16
45 1 5/8 1 11/16 1 3/4	UELT209D1W3	19	18	83	49	29	83	16	102	117	145	35	49
	UELT209-110D1W3												
	UELT209-111D1W3												
	UELT209-112D1W3	3/4	23/32	3 3/32	1 15/16	1 5/32	3 9/32	0.630	4 1/64	4 19/32	5 23/32	1 3/8	1 15/16
50 1 13/16 1 7/8 1 15/16 2	UELT210D1W3	19	18	83	49	29	86	16	102	117	151	37	49
	UELT210-113D1W3												
	UELT210-114D1W3												
	UELT210-115D1W3	3/4	23/32	3 3/32	1 15/16	1 5/32	3 3/8	0.630	4 1/64	4 19/32	5 15/16	1 15/32	1 15/16
	UELT210-200D1W3												

Note (1) These numbers indicate relubricatable type. If maintenance free type is needed, please order without suffix "D1".

Remarks Please refer to page A21 for size of grease fitting.

Nominal dimensions				Bearing number	Housing number	Mass of unit
mm inch						
<i>r</i>	<i>L</i> <sub>1</sub>	<i>B</i> <sub>1</sub>	<i>S</i>			kg lb
33	61	43.7	17.1	UEL204D1W3	T204D1	0.6
1 $\frac{5}{16}$	2 $\frac{13}{32}$	1.720	0.673	UEL204-012D1W3	T204D1	1.3
35	62	44.4	17.5	UEL205D1W3	T205D1	0.9
				UEL205-013D1W3	T205D1	
				UEL205-014D1W3	T205D1	
1 $\frac{3}{8}$	2 $\frac{7}{16}$	1.748	0.687	UEL205-015D1W3	T205D1	2.0
				UEL205-100D1W3	T205D1	
43	70	48.4	18.25	UEL206D1W3	T206D1	1.4
				UEL206-101D1W3	T206D1	
				UEL206-102D1W3	T206D1	
1 $\frac{11}{16}$	2 $\frac{3}{4}$	1.906	0.719	UEL206-103D1W3	T206D1	3.1
				UEL206-104D1W3	T206D1	
51	78	51.1	18.8	UEL207D1W3	T207D1	1.7
				UEL207-104D1W3	T207D1	
				UEL207-105D1W3	T207D1	
2	3 $\frac{1}{16}$	2.012	0.740	UEL207-106D1W3	T207D1	3.7
				UEL207-107D1W3	T207D1	
56	88	56.3	21.4	UEL208D1W3	T208D1	2.5
				UEL208-108D1W3	T208D1	
2 $\frac{7}{32}$	3 $\frac{15}{32}$	2.217	0.843	UEL208-109D1W3	T208D1	5.5
57	88	56.3	21.4	UEL209D1W3	T209D1	2.5
				UEL209-110D1W3	T209D1	
				UEL209-111D1W3	T209D1	
2 $\frac{1}{4}$	3 $\frac{15}{32}$	2.217	0.843	UEL209-112D1W3	T209D1	5.5
59	92	62.7	24.6	UEL210D1W3	T210D1	2.7
				UEL210-113D1W3	T210D1	
				UEL210-114D1W3	T210D1	
2 $\frac{5}{16}$	3 $\frac{5}{8}$	2.469	0.969	UEL210-115D1W3	T210D1	6.0
				UEL210-200D1W3	T210D1	

## Take-up unit, cast housing Eccentric locking collar type

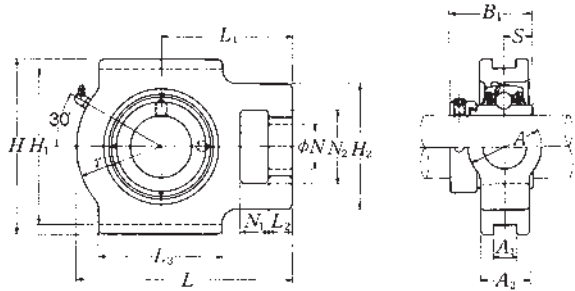

Shaft dia. mm inch	Unit number (1)	Nominal dimensions											
		mm inch											
		$N_1$	$L_2$	$H_2$	$N_2$	$N$	$L_3$	$A_1$	$H_1$	$H$	$L$	$A_2$	$A$
55	UULT211D1W3	25	21	102	64	35	95	22	130	146	171	38	64
2	UULT211-200D1W3												
2 1/16	UULT211-201D1W3	31/32	13/16	4 1/32	2 17/32	1 3/8	3 3/4	0.866	5 7/8	5 3/4	6 23/32	1 1/2	2 17/32
2 1/8	UULT211-202D1W3												
2 3/16	UULT211-203D1W3												
60	UULT212D1W3	32	21	102	64	35	102	22	130	146	194	42	64
2 1/4	UULT212-204D1W3												
2 5/16	UULT212-205D1W3	1 1/4	13/16	4 1/32	2 17/32	1 3/8	4 1/32	0.866	5 7/8	5 3/4	7 5/8	1 21/32	2 17/32
2 3/8	UULT212-206D1W3												
2 7/16	UULT212-207D1W3												
65	UULT213D1W3	32	23	111	70	41	121	26	151	167	224	44	70
2 1/2	UULT213-208D1W3	1 1/4	29/32	4 3/8	2 3/4	1 5/8	4 3/4	1.024	5 15/16	6 9/16	8 13/16	1 29/32	2 3/4
2 9/16	UULT213-209D1W3												
70	UULT214D1W3	32	23	111	70	41	121	26	151	167	224	46	70
2 5/8	UULT214-210D1W3												
2 11/16	UULT214-211D1W3	1 1/4	29/32	4 3/8	2 3/4	1 5/8	4 3/4	1.024	5 15/16	6 9/16	8 13/16	1 13/16	2 3/4
2 3/4	UULT214-212D1W3												
75	UULT215D1W3	32	23	111	70	41	121	26	151	167	232	48	70
2 13/16	UULT215-213D1W3												
2 7/8	UULT215-214D1W3	1 1/4	29/32	4 3/8	2 3/4	1 5/8	4 3/4	1.024	5 15/16	6 9/16	9 1/8	1 7/8	2 3/4
2 15/16	UULT215-215D1W3												
3	UULT215-300D1W3												

Note (1) These numbers indicate relubricatable type. If maintenance free type is needed, please order without suffix "D1".

Remarks Please refer to page A21 for size of grease fitting.

Nominal dimensions				Bearing number	Housing number	Mass of unit
mm inch						
<i>r</i>	<i>L</i> <sub>1</sub>	<i>B</i> <sub>1</sub>	<i>S</i>			kg lb
65	106	71.4	27.75	UEL211D1W3	T211D1	4.2
				UEL211-200D1W3	T211D1	
2 $\frac{9}{16}$	4 $\frac{3}{16}$	2.811	1.093	UEL211-201D1W3	T211D1	9.3
				UEL211-202D1W3	T211D1	
				UEL211-203D1W3	T211D1	
75	119	77.8	30.95	UEL212D1W3	T212D1	5.2
				UEL212-204D1W3	T212D1	
2 $\frac{15}{16}$	4 $\frac{11}{16}$	3.063	1.219	UEL212-205D1W3	T212D1	11
				UEL212-206D1W3	T212D1	
				UEL212-207D1W3	T212D1	
87	137	85.7	34.15	UEL213D1W3	T213D1	7.7
				UEL213-208D1W3	T213D1	
3 $\frac{7}{16}$	5 $\frac{19}{32}$	3.374	1.344	UEL213-209D1W3	T213D1	17
87	137	85.7	34.15	UEL214D1W3	T214D1	7.3
				UEL214-210D1W3	T214D1	
3 $\frac{7}{16}$	5 $\frac{19}{32}$	3.374	1.344	UEL214-211D1W3	T214D1	16
				UEL214-212D1W3	T214D1	
92	140	92	37.3	UEL215D1W3	T215D1	7.8
				UEL215-213D1W3	T215D1	
3 $\frac{5}{8}$	5 $\frac{1}{2}$	3.622	1.469	UEL215-214D1W3	T215D1	17
				UEL215-215D1W3	T215D1	
				UEL215-300D1W3	T215D1	

## Take-up unit, cast housing Eccentric locking collar type

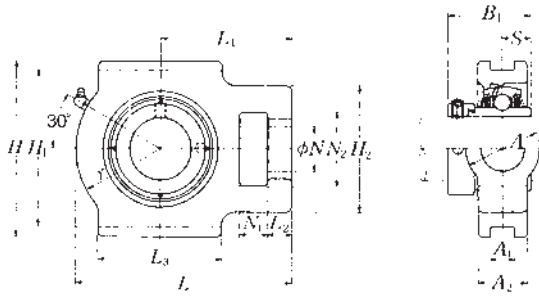

Shaft dia. mm inch	Unit number (1)	Nominal dimensions											
		mm inch											
		$N_1$	$L_2$	$H_2$	$N_2$	$N$	$L_3$	$A_1$	$H_1$	$H$	$L$	$A_2$	$A$
25 13/16 7/8 15/16 1	UELT305D1W3 UELT305-013D1W3 UELT305-014D1W3 UELT305-015D1W3 UELT305-100D1W3	16 5/8	14 9/16	62 2 7/16	36 1 13/32	26 1 1/32	65 2 9/16	12 0.472	80 3 5/32	89 3 1/2	122 4 13/16	26 1 1/32	36 1 13/32
30 1 1/16 1 1/8 1 3/16	UELT306D1W3 UELT306-101D1W3 UELT306-102D1W3 UELT306-103D1W3	18 23/32	16 5/8	70 2 3/4	41 1 5/8	28 1 3/32	74 2 29/32	16 0.630	90 3 5/64	100 3 1/16	137 5 13/32	28 1 3/32	41 1 5/8
35 1 1/4 1 5/16 1 3/8 1 7/16	UELT307D1W3 UELT307-104D1W3 UELT307-105D1W3 UELT307-106D1W3 UELT307-107D1W3	20 25/32	17 2 1/32	75 2 15/16	45 1 25/32	30 1 3/16	80 3 5/32	16 0.630	100 3 15/16	111 4 3/8	150 5 29/32	32 1 1/4	45 1 25/32
40 1 1/2 1 9/16	UELT308D1W3 UELT308-108D1W3 UELT308-109D1W3	22 7/8	19 3/4	83 3 9/32	50 1 31/32	32 1 1/4	89 3 1/2	18 0.709	112 4 13/32	124 4 7/8	162 6 3/8	34 1 1/32	50 1 31/32
45 1 5/8 1 11/16 1 3/4	UELT309D1W3 UELT309-110D1W3 UELT309-111D1W3 UELT309-112D1W3	24 15/16	20 25/32	90 3 17/32	55 2 5/32	34 1 11/32	97 3 13/16	18 0.709	125 4 59/64	138 5 7/16	178 7	38 1 1/2	55 2 5/32
50 1 13/16 1 7/8 1 15/16	UELT310D1W3 UELT310-113D1W3 UELT310-114D1W3 UELT310-115D1W3	27 1 1/16	22 7/8	98 3 27/32	61 2 13/32	37 1 15/32	106 4 3/16	20 0.787	140 5 33/64	151 5 15/16	192 7 9/16	40 1 3/16	61 2 13/32

Note (1) These numbers indicate relubricatable type. If maintenance free type is needed, please order without suffix "D1".

Remarks Please refer to page A21 for size of grease fitting.

Nominal dimensions				Bearing number	Housing number	Mass of unit kg lb
mm inch						
<i>r</i>	<i>L</i> <sub>1</sub>	<i>B</i> <sub>1</sub>	<i>S</i>			
46	76	46.8	16.7	UEL305D1W3	T305D1	1.4
1 $\frac{13}{16}$	3	1.843	0.657	UEL305-013D1W3	T305D1	3.1
				UEL305-014D1W3	T305D1	
				UEL305-015D1W3	T305D1	
				UEL305-100D1W3	T305D1	
52	85	50	17.5	UEL306D1W3	T306D1	1.9
2 $\frac{7}{16}$	3 $\frac{11}{32}$	1.969	0.689	UEL306-101D1W3	T306D1	4.2
				UEL306-102D1W3	T306D1	
				UEL306-103D1W3	T306D1	
56	94	51.6	18.3	UEL307D1W3	T307D1	2.4
2 $\frac{7}{32}$	3 $\frac{1}{16}$	2.031	0.720	UEL307-104D1W3	T307D1	5.3
				UEL307-105D1W3	T307D1	
				UEL307-106D1W3	T307D1	
				UEL307-107D1W3	T307D1	
62	100	57.1	19.8	UEL308D1W3	T308D1	3.1
2 $\frac{7}{16}$	3 $\frac{15}{16}$	2.248	0.780	UEL308-108D1W3	T308D1	6.8
				UEL308-109D1W3	T308D1	
68	110	58.7	19.8	UEL309D1W3	T309D1	4.1
2 $\frac{1}{16}$	4 $\frac{11}{32}$	2.311	0.780	UEL309-110D1W3	T309D1	9.0
				UEL309-111D1W3	T309D1	
				UEL309-112D1W3	T309D1	
74	118	66.6	24.6	UEL310D1W3	T310D1	5.2
2 $\frac{29}{32}$	4 $\frac{21}{32}$	2.622	0.969	UEL310-113D1W3	T310D1	11
				UEL310-114D1W3	T310D1	
				UEL310-115D1W3	T310D1	



## Take-up unit, cast housing Eccentric locking collar type

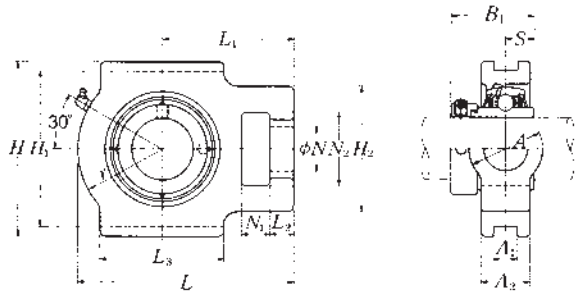

Shaft dia. mm inch	Unit number (1)	Nominal dimensions											
		mm inch											
		$N_1$	$L_2$	$H_2$	$N_2$	$N$	$L_3$	$A_1$	$H_1$	$H$	$L$	$A_2$	$A$
55 2	<b>UELT311D1W3</b>	29	23	105	66	39	115	22	150	163	207	44	66
2 1/16	<b>UELT311-200D1W3</b>												
2 1/8	<b>UELT311-201D1W3</b>	1 5/32	29/32	4 1/8	2 19/32	1 17/32	4 17/32	0.866	5 29/32	6 13/32	8 5/32	1 23/32	2 19/32
2 3/16	<b>UELT311-202D1W3</b>												
	<b>UELT311-203D1W3</b>												
60 2 1/4	<b>UELT312D1W3</b>	31	25	113	71	41	123	22	160	178	220	46	71
2 5/16	<b>UELT312-204D1W3</b>												
2 3/8	<b>UELT312-205D1W3</b>	1 7/32	3 1/32	4 7/16	2 25/32	1 5/8	4 27/32	0.866	6 19/64	7	8 21/32	1 19/16	2 25/32
2 7/16	<b>UELT312-206D1W3</b>												
	<b>UELT312-207D1W3</b>												
65 2 1/2	<b>UELT313D1W3</b>	32	27	116	70	43	134	26	170	190	238	50	80
2 9/16	<b>UELT313-208D1W3</b>												
	<b>UELT313-209D1W3</b>	1 1/4	1 1/16	4 9/16	2 3/4	1 11/16	5 9/32	1.024	6 11/16	7 15/32	9 5/8	1 31/32	3 5/32
70 2 5/8	<b>UELT314D1W3</b>	36	27	130	85	46	140	26	180	202	252	52	90
2 11/16	<b>UELT314-210D1W3</b>												
2 3/4	<b>UELT314-211D1W3</b>	1 13/32	1 1/16	5 1/8	3 11/32	1 15/16	5 1/2	1.024	7 3/32	7 15/16	9 29/32	2 1/16	3 17/32
	<b>UELT314-212D1W3</b>												
75 2 13/16	<b>UELT315D1W3</b>	36	27	132	85	46	150	26	192	216	262	55	90
2 7/8	<b>UELT315-213D1W3</b>												
2 15/16	<b>UELT315-214D1W3</b>	1 13/32	1 1/16	5 3/16	3 11/32	1 13/16	5 29/32	1.024	7 9/16	8 1/2	10 5/16	2 5/32	3 17/32
3	<b>UELT315-215D1W3</b>												
	<b>UELT315-300D1W3</b>												
80 3 1/16	<b>UELT316D1W3</b>	42	30	150	98	53	160	30	204	230	282	60	102
3 1/8	<b>UELT316-301D1W3</b>												
3 3/16	<b>UELT316-302D1W3</b>	1 21/32	1 3/16	5 29/32	3 27/32	2 3/32	6 5/16	1.181	8 1/32	9 1/16	11 3/32	2 3/8	4 1/32
	<b>UELT316-303D1W3</b>												

Note (1) These numbers indicate relubricatable type. If maintenance free type is needed, please order without suffix "D1".

Remarks Please refer to page A21 for size of grease fitting.

Nominal dimensions				Bearing number	Housing number	Mass of unit
mm inch						
<i>r</i>	<i>L</i> <sub>1</sub>	<i>B</i> <sub>1</sub>	<i>S</i>			kg lb
80	127	73	27.8	UEL311D1W3	T311D1	6.6
3 $\frac{5}{32}$	5	2.874	1.094	UEL311-200D1W3	T311D1	15
				UEL311-201D1W3	T311D1	
				UEL311-202D1W3	T311D1	
				UEL311-203D1W3	T311D1	
85	135	79.4	30.95	UEL312D1W3	T312D1	7.9
3 $\frac{1}{32}$	5 $\frac{5}{16}$	3.126	1.219	UEL312-204D1W3	T312D1	17
				UEL312-205D1W3	T312D1	
				UEL312-206D1W3	T312D1	
				UEL312-207D1W3	T312D1	
92	146	85.7	32.55	UEL313D1W3	T313D1	9.8
3 $\frac{5}{8}$	5 $\frac{3}{4}$	3.374	1.281	UEL313-208D1W3	T313D1	22
				UEL313-209D1W3	T313D1	
97	155	92.1	34.15	UEL314D1W3	T314D1	11
3 $\frac{9}{16}$	6 $\frac{3}{32}$	3.626	1.344	UEL314-210D1W3	T314D1	24
				UEL314-211D1W3	T314D1	
				UEL314-212D1W3	T314D1	
102	160	100	37.3	UEL315D1W3	T315D1	14
4 $\frac{1}{32}$	6 $\frac{5}{16}$	3.937	1.469	UEL315-213D1W3	T315D1	31
				UEL315-214D1W3	T315D1	
				UEL315-215D1W3	T315D1	
				UEL315-300D1W3	T315D1	
108	174	106.4	40.5	UEL316D1W3	T316D1	17
4 $\frac{1}{4}$	6 $\frac{27}{32}$	4.189	1.594	UEL316-301D1W3	T316D1	37
				UEL316-302D1W3	T316D1	
				UEL316-303D1W3	T316D1	

## Take-up unit, cast housing Eccentric locking collar type

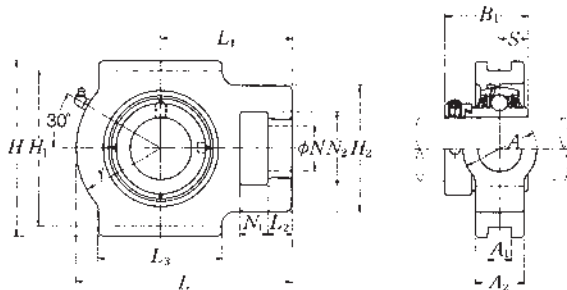

Shaft dia. mm inch	Unit number (*)	Nominal dimensions											
		mm inch											
		$N_1$	$L_2$	$H_2$	$N_2$	$N$	$L_3$	$A_1$	$H_1$	$H$	$L$	$A_2$	$A$
85 3 3/4 3 5/16 3 7/16	UELT317D1W3 UELT317-304D1W3 UELT317-305D1W3 UELT317-307D1W3	42	32	152	98	53	170	32	214	240	298	64	102
		1 21/32	1 1/4	5 31/32	3 27/32	2 3/32	6 11/16	1.260	8 27/64	9 7/16	11 23/32	2 17/32	4 1/32
90 3 7/16 3 1/2	UELT318D1W3 UELT318-307D1W3 UELT318-308D1W3	46	32	160	106	57	175	32	228	255	312	66	110
		1 19/16	1 1/4	6 3/16	4 3/16	2 1/4	6 7/8	1.260	8 31/32	10 1/32	12 9/32	2 19/32	4 11/32
95 3 5/8 3 11/16 3 3/4	UELT319D1W3 UELT319-310D1W3 UELT319-311D1W3 UELT319-312D1W3	46	33	165	106	57	180	35	240	270	322	72	110
		1 13/16	1 5/16	6 1/2	4 3/16	2 1/4	7 3/32	1.378	9 29/64	10 5/8	12 11/16	2 27/32	4 11/32
100 3 13/16 3 7/8 3 15/16 4	UELT320D1W3 UELT320-313D1W3 UELT320-314D1W3 UELT320-315D1W3 UELT320-400D1W3	48	34	175	115	59	200	35	260	290	345	75	120
		1 7/8	1 11/32	6 7/8	4 17/32	2 5/16	7 7/8	1.378	10 15/64	11 19/32	13 19/32	2 15/16	4 23/32
105	UELT321D1W3	48	34	175	115	59	200	35	260	290	347	75	120
110	UELT322D1W3	52	40	185	125	65	215	38	285	320	385	80	130

Note (\*) These numbers indicate relubricatable type. If maintenance free type is needed, please order without suffix "D1".

Remarks Please refer to page A21 for size of grease fitting.

<b>Nominal dimensions</b>				<b>Bearing number</b>	<b>Housing number</b>	<b>Mass of unit</b>
mm inch						
<i>r</i>	<i>L</i> <sub>1</sub>	<i>B</i> <sub>1</sub>	<i>S</i>			kg lb
115	183	109.5	42.05	UEL317D1W3	T317D1	20
				UEL317-304D1W3	T317D1	
4 <sup>17</sup> / <sub>32</sub>	7 <sup>7</sup> / <sub>32</sub>	4.311	1.656	UEL317-305D1W3	T317D1	44
				UEL317-307D1W3	T317D1	
120	192	115.9	43.65	UEL318D1W3	T318D1	23
				UEL318-307D1W3	T318D1	
4 <sup>29</sup> / <sub>32</sub>	7 <sup>9</sup> / <sub>16</sub>	4.563	1.719	UEL318-308D1W3	T318D1	51
125	197	122.3	38.9	UEL319D1W3	T319D1	26
				UEL319-310D1W3	T319D1	
4 <sup>29</sup> / <sub>32</sub>	7 <sup>3</sup> / <sub>4</sub>	4.815	1.531	UEL319-311D1W3	T319D1	57
				UEL319-312D1W3	T319D1	
135	210	128.6	50	UEL320D1W3	T320D1	32
				UEL320-313D1W3	T320D1	
				UEL320-314D1W3	T320D1	
5 <sup>3</sup> / <sub>16</sub>	8 <sup>3</sup> / <sub>32</sub>	5.063	1.969	UEL320-315D1W3	T320D1	71
				UEL320-400D1W3	T320D1	
135	212	139.7	48.4	UEL321D1D1W3	T321D1	33
150	235	141.3	49.2	UEL322D1D1W3	T322D1	42

# AELPT2 -

## Take-up mini stretcher Units™ Eccentric locking collar type

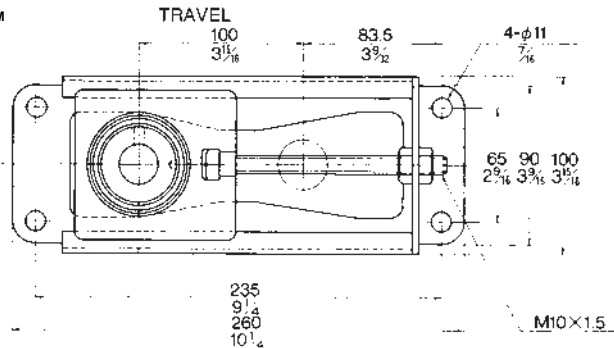

Shaft dia. mm inch	Unit number	Nominal dimensions			Bolt size mm inch	Max. load (1) recommended N lbf
		A	B <sub>1</sub>	S		
12 1/2	<b>AELPT201-10W3</b>	37.1	28.6	6.5	M10	3 430
	<b>AELPT201-008-10W3</b>	1 <sup>29</sup> / <sub>64</sub>	1.126	0.256	3/8	770
15 9/16 5/8	<b>AELPT202-10W3</b>	37.1	28.6	6.5	M10	3 430
	<b>AELPT202-009-10W3</b> <b>AELPT202-010-10W3</b>	1 <sup>29</sup> / <sub>64</sub>	1.126	0.256	3/8	770
17 1 1/16	<b>AELPT203-10W3</b>	37.1	28.6	6.5	M10	3 430
	<b>AELPT203-011-10W3</b>	1 <sup>29</sup> / <sub>64</sub>	1.126	0.256	3/8	770
20 3/4	<b>AELPT204-10W3</b>	38.5	31	7.5	M10	3 430
	<b>AELPT204-012-10W3</b>	1 <sup>33</sup> / <sub>64</sub>	1.220	0.295	3/8	770
25 13/16 7/8 15/16 1	<b>AELPT205-10W3</b>	38.5	31	7.5	M10	3 430
	<b>AELPT205-013-10W3</b>	1 <sup>33</sup> / <sub>64</sub>	1.220	0.295	3/8	770
	<b>AELPT205-014-10W3</b>					
	<b>AELPT205-015-10W3</b>					
<b>AELPT205-100-10W3</b>						

Note (1) The Stretcher Units is designed to only take a horizontal radial load, in line with the adjustment direction. Axial loads or vertical radial loads can deform or break the housing.

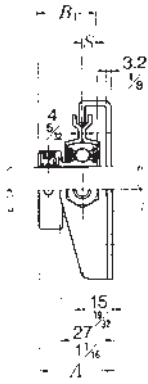

Bearing number	Mass of unit
	kg lb
AEL201W3	1.1
AEL201-008W3	2.4
AEL202W3	1.1
AEL202-009W3	2.4
AEL202-010W3	
AEL203W3	1.1
AEL203-011W3	2.4
AEL204W3	1.1
AEL204-012W3	2.4
AEL205W3	1.2
AEL205-013W3	
AEL205-014W3	2.6
AEL205-015W3	
AEL205-100W3	

## Take-up mini stretcher Units™ Eccentric locking collar type

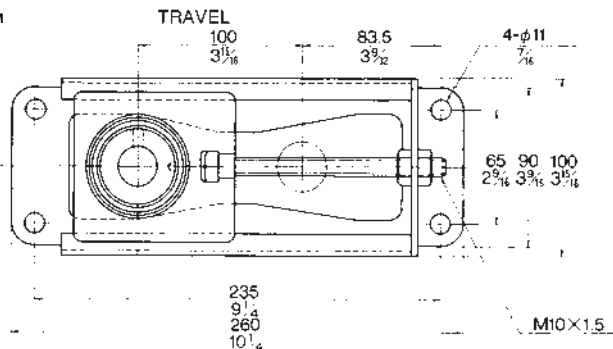

Shaft dia. mm inch	Unit number	Nominal dimensions			Bolt size mm inch	Max. load (1) recommended N lbf
		A	B <sub>1</sub>	S		
12 1/2	JELPT201-10W3	37.1	28.6	6.5	M10	3 430
	JELPT201-008-10W3	1 29/64	1.126	0.256	3/8	770
15 9/16 5/8	JELPT202-10W3	37.1	28.6	6.5	M10	3 430
	JELPT202-009-10W3 JELPT202-010-10W3	1 29/64	1.126	0.256	3/8	770
17 1 1/16	JELPT203-10W3	37.1	28.6	6.5	M10	3 430
	JELPT203-011-10W3	1 29/64	1.126	0.256	3/8	770
20 3/4	JELPT204-10W3	38.5	31	7.5	M10	3 430
	JELPT204-012-10W3	1 33/64	1.220	0.295	3/8	770
25 13/16 7/8 15/16 1	JELPT205-10W3	38.5	31	7.5	M10	3 430
	JELPT205-013-10W3					
	JELPT205-014-10W3					
	JELPT205-015-10W3	1 33/64	1.220	0.295	3/8	770
	JELPT205-100-10W3					

**Note (1)** The Stretcher Units is designed to only take a horizontal radial load, in line with the adjustment direction. Axial loads or vertical radial loads can deform or break the housing.

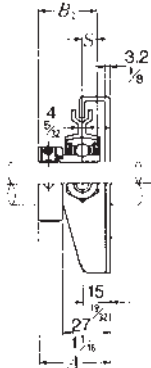

**JELPT type**

Bearing number	Mass of unit kg lb
JEL201W3 JEL201-008W3	1.1 2.4
JEL202W3 JEL202-009W3 JEL202-010W3	1.1 2.4
JEL203W3 JEL203-011W3	1.1 2.4
JEL204W3 JEL204-012W3	1.1 2.4
JEL205W3 JEL205-013W3 JEL205-014W3 JEL205-015W3 JEL205-100W3	1.2 2.6



## Cartridge unit, cast housing Eccentric locking collar type

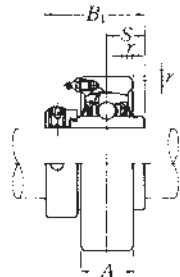
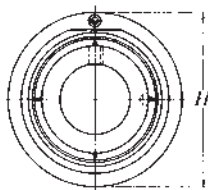

Shaft dia. mm inch	Unit number (*)	Nominal dimensions mm inch					Bearing number	Housing number	Mass of unit kg lb
		H	A	r	B <sub>1</sub>	S			
20 3/4	UEL204D1W3	72	20	2	43.7	17.1	UEL204D1W3	C204D1	0.6
	UEL204-012D1W3	2.8346	25/32	0.079	1.720	0.673	UEL204-012D1W3	C204D1	1.3
25 13/16 7/8 15/16 1	UEL205D1W3	80	22	2	44.4	17.45	UEL205D1W3	C205D1	0.7
	UEL205-013D1W3	3.1496	55/64	0.079	1.748	0.687	UEL205-013D1W3	C205D1	1.5
	UEL205-014D1W3						C205D1		
	UEL205-015D1W3						C205D1		
UEL205-100D1W3	C205D1								
30 1 1/16 1 1/8 1 3/16 1 1/4	UEL206D1W3	85	27	2	48.4	18.25	UEL206D1W3	C206D1	0.9
	UEL206-101D1W3	3.3465	1 1/16	0.079	1.906	0.719	UEL206-101D1W3	C206D1	2.0
	UEL206-102D1W3						C206D1		
	UEL206-103D1W3						C206D1		
UEL206-104D1W3	C206D1								
35 1 1/4 1 5/16 1 3/8 1 7/16	UEL207D1W3	90	28	2	51.1	18.8	UEL207D1W3	C207D1	1.0
	UEL207-104D1W3	3.5433	1 7/64	0.079	2.012	0.740	UEL207-104D1W3	C207D1	2.2
	UEL207-105D1W3						C207D1		
	UEL207-106D1W3						C207D1		
UEL207-107D1W3	C207D1								
40 1 1/2 1 5/16	UEL208D1W3	100	30	2.5	56.3	21.4	UEL208D1W3	C208D1	1.4
	UEL208-108D1W3	3.9370	1 3/16	0.098	2.217	0.843	UEL208-108D1W3	C208D1	3.1
	UEL208-109D1W3						C208D1		
45 1 5/8 1 11/16 1 3/4	UEL209D1W3	110	31	2.5	56.3	21.4	UEL209D1W3	C209D1	1.6
	UEL209-110D1W3	4.3307	1 7/32	0.098	2.217	0.843	UEL209-110D1W3	C209D1	3.5
	UEL209-111D1W3						C209D1		
UEL209-112D1W3	C209D1								

Note (\*) These numbers indicate relubricatable type. If maintenance free type is needed, please order without suffix "D1".

Remarks Please refer to page A21 for size of grease fitting.

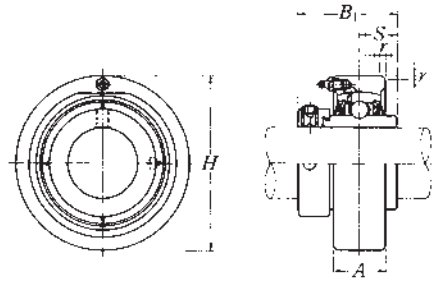

Shaft dia. mm inch	Unit number (*)	Nominal dimensions					Bearing number	Housing number	Mass of unit kg lb
		mm inch							
		<i>H</i>	<i>A</i>	<i>r</i>	<i>B</i> <sub>1</sub>	<i>S</i>			
50	<b>UEL210D1W3</b>	120	33	2.5	62.7	24.6	<b>UEL210D1W3</b>	<b>C210D1</b>	2.1
1 <sup>13</sup> / <sub>16</sub>	<b>UEL210-113D1W3</b>						UEL210-113D1W3	C210D1	
1 <sup>7</sup> / <sub>8</sub>	<b>UEL210-114D1W3</b>	4.7244	1 <sup>19</sup> / <sub>64</sub>	0.098	2.469	0.969	UEL210-114D1W3	C210D1	4.6
1 <sup>15</sup> / <sub>16</sub>	<b>UEL210-115D1W3</b>						UEL210-115D1W3	C210D1	
2	<b>UEL210-200D1W3</b>						UEL210-200D1W3	C210D1	
55	<b>UEL211D1W3</b>	125	35	2.5	71.4	27.75	<b>UEL211D1W3</b>	<b>C211D1</b>	2.4
2	<b>UEL211-200D1W3</b>						UEL211-200D1W3	C211D1	
2 <sup>1</sup> / <sub>16</sub>	<b>UEL211-201D1W3</b>	4.9213	1 <sup>3</sup> / <sub>8</sub>	0.098	2.811	1.093	UEL211-201D1W3	C211D1	5.3
2 <sup>1</sup> / <sub>8</sub>	<b>UEL211-202D1W3</b>						UEL211-202D1W3	C211D1	
2 <sup>3</sup> / <sub>16</sub>	<b>UEL211-203D1W3</b>						UEL211-203D1W3	C211D1	
60	<b>UEL212D1W3</b>	130	38	2.5	77.8	30.95	<b>UEL212D1W3</b>	<b>C212D1</b>	2.8
2 <sup>1</sup> / <sub>4</sub>	<b>UEL212-204D1W3</b>						UEL212-204D1W3	C212D1	
2 <sup>5</sup> / <sub>16</sub>	<b>UEL212-205D1W3</b>	5.1181	1 <sup>1</sup> / <sub>2</sub>	0.098	3.063	1.219	UEL212-205D1W3	C212D1	6.2
2 <sup>3</sup> / <sub>8</sub>	<b>UEL212-206D1W3</b>						UEL212-206D1W3	C212D1	
2 <sup>7</sup> / <sub>16</sub>	<b>UEL212-207D1W3</b>						UEL212-207D1W3	C212D1	

**Note (\*)** These numbers indicate relubricatable type. If maintenance free type is needed, please order without suffix "D1".

**Remarks** Please refer to page A21 for size of grease fitting.

## Cartridge unit, cast housing Eccentric locking collar type

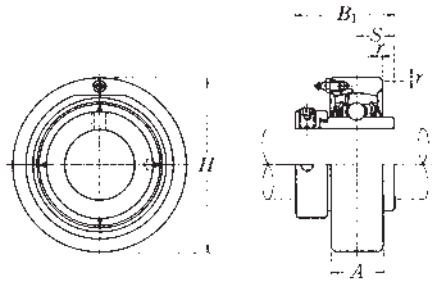

Shaft dia. mm inch	Unit number (1)	Nominal dimensions					Bearing number	Housing number	Mass of unit kg lb
		mm inch							
		H	A	r	B <sub>1</sub>	S			
25 1 3/16 7/8 15/16 1	UEL305D1W3	90	26	2.5	46.8	16.7	UEL305D1W3	C305D1	1.0
	UEL305-013D1W3	3.5433	1 1/32	0.098	1.843	0.657	UEL305-013D1W3	C305D1	2.2
	UEL305-014D1W3						C305D1		
	UEL305-015D1W3						C305D1		
	UEL305-100D1W3						C305D1		
30 1 1/16 1 1/8 1 3/16	UEL306D1W3	100	28	2.5	50	17.5	UEL306D1W3	C306D1	1.4
	UEL306-101D1W3	3.9370	1 7/64	0.098	1.969	0.689	UEL306-101D1W3	C306D1	3.1
	UEL306-102D1W3						C306D1		
	UEL306-103D1W3						C306D1		
35 1 1/4 1 5/16 1 3/8 1 7/16	UEL307D1W3	110	32	3	51.6	18.3	UEL307D1W3	C307D1	1.8
	UEL307-104D1W3	4.3307	1 17/64	0.118	2.031	0.720	UEL307-104D1W3	C307D1	4.0
	UEL307-105D1W3						C307D1		
	UEL307-106D1W3						C307D1		
	UEL307-107D1W3						C307D1		
40 1 1/2 1 9/16	UEL308D1W3	120	34	3	57.1	19.8	UEL308D1W3	C308D1	2.3
	UEL308-108D1W3	4.7244	1 11/32	0.118	2.248	0.780	UEL308-108D1W3	C308D1	5.1
	UEL308-109D1W3						C308D1		
45 1 5/8 1 11/16 1 3/4	UEL309D1W3	130	38	3.5	58.7	19.8	UEL309D1W3	C309D1	2.9
	UEL309-110D1W3	5.1181	1 1/2	0.138	2.311	0.780	UEL309-110D1W3	C309D1	6.4
	UEL309-111D1W3						C309D1		
	UEL309-112D1W3						C309D1		
50 1 13/16 1 7/8 1 15/16	UEL310D1W3	140	40	3.5	66.6	24.6	UEL310D1W3	C310D1	3.5
	UEL310-113D1W3	5.5118	1 37/64	0.138	2.622	0.969	UEL310-113D1W3	C310D1	7.7
	UEL310-114D1W3						C310D1		
	UEL310-115D1W3						C310D1		

Note (1) These numbers indicate relubricatable type. If maintenance free type is needed, please order without suffix "D1".

Remarks Please refer to page A21 for size of grease fitting.

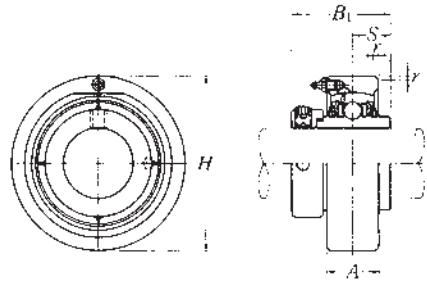

Shaft dia. mm inch	Unit number (1)	Nominal dimensions					Bearing number	Housing number	Mass of unit kg lb
		H	A	r	B <sub>1</sub>	S			
55 2 2 1/16 2 1/8 2 3/16	<b>UEL311D1W3</b>	150	44	3.5	73	27.8	<b>UEL311D1W3</b>	<b>C311D1</b>	4.3
	<b>UEL311-200D1W3</b>						UEL311-200D1W3	C311D1	9.5
	<b>UEL311-201D1W3</b>	5.9055	1 47/64	0.138	2.874	1.094	UEL311-201D1W3	C311D1	
	<b>UEL311-202D1W3</b>						UEL311-202D1W3	C311D1	
	<b>UEL311-203D1W3</b>						UEL311-203D1W3	C311D1	
60 2 1/4 2 5/16 2 3/8 2 7/16	<b>UEL312D1W3</b>	160	46	3.5	79.4	30.95	<b>UEL312D1W3</b>	<b>C312D1</b>	5.1
	<b>UEL312-204D1W3</b>						UEL312-204D1W3	C312D1	11
	<b>UEL312-205D1W3</b>	6.2992	1 19/16	0.138	3.126	1.219	UEL312-205D1W3	C312D1	
	<b>UEL312-206D1W3</b>						UEL312-206D1W3	C312D1	
	<b>UEL312-207D1W3</b>						UEL312-207D1W3	C312D1	
65 2 1/2 2 9/16	<b>UEL313D1W3</b>	170	50	3.5	85.7	32.55	<b>UEL313D1W3</b>	<b>C313D1</b>	6.2
	<b>UEL313-208D1W3</b>	6.6929	1 39/32	0.138	3.374	1.281	UEL313-208D1W3	C313D1	14
	<b>UEL313-209D1W3</b>						UEL313-209D1W3	C313D1	
70 2 5/8 2 11/16 2 3/4	<b>UEL314D1W3</b>	180	52	4	92.1	34.15	<b>UEL314D1W3</b>	<b>C314D1</b>	7.3
	<b>UEL314-210D1W3</b>						UEL314-210D1W3	C314D1	16
	<b>UEL314-211D1W3</b>	7.0866	2 3/64	0.157	3.626	1.344	UEL314-211D1W3	C314D1	
<b>UEL314-212D1W3</b>						UEL314-212D1W3	C314D1		
75 2 13/16 2 7/8 2 15/16 3	<b>UEL315D1W3</b>	190	55	4	100	37.3	<b>UEL315D1W3</b>	<b>C315D1</b>	8.5
	<b>UEL315-213D1W3</b>						UEL315-213D1W3	C315D1	19
	<b>UEL315-214D1W3</b>	7.4803	2 11/64	0.157	3.937	1.469	UEL315-214D1W3	C315D1	
	<b>UEL315-215D1W3</b>						UEL315-215D1W3	C315D1	
	<b>UEL315-300D1W3</b>						UEL315-300D1W3	C315D1	
80 3 1/16 3 1/8 3 3/16	<b>UEL316D1W3</b>	200	60	4	106.4	40.5	<b>UEL316D1W3</b>	<b>C316D1</b>	10
	<b>UEL316-301D1W3</b>						UEL316-301D1W3	C316D1	22
	<b>UEL316-302D1W3</b>	7.8740	2 23/64	0.157	4.189	1.594	UEL316-302D1W3	C316D1	
	<b>UEL316-303D1W3</b>						UEL316-303D1W3	C316D1	

Note (1) These numbers indicate relubricatable type. If maintenance free type is needed, please order without suffix "D1".

Remarks Please refer to page A21 for size of grease fitting.

## Cartridge unit, cast housing Eccentric locking collar type

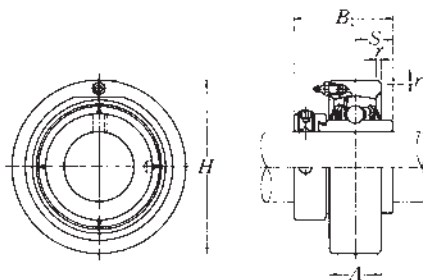

Shaft dia. mm inch	Unit number (1)	Nominal dimensions mm inch					Bearing number	Housing number	Mass of unit kg lb
		H	A	r	B <sub>1</sub>	S			
85 3 1/4	<b>UELC317D1W3</b>	215	64	4	109.5	42.05	<b>UEL317D1W3</b>	<b>C317D1</b>	13
3 5/16	<b>UELC317-304D1W3</b>	8.4646	2 33/64	0.157	4.311	1.656	UEL317-304D1W3	C317D1	29
3 5/16	<b>UELC317-305D1W3</b>						UEL317-305D1W3	C317D1	
3 7/16	<b>UELC317-307D1W3</b>						UEL317-307D1W3	C317D1	
90 3 7/16	<b>UELC318D1W3</b>	225	66	4	115.9	43.65	<b>UEL318D1W3</b>	<b>C318D1</b>	14
3 1/2	<b>UELC318-307D1W3</b>	8.8583	2 19/32	0.157	4.563	1.719	UEL318-307D1W3	C318D1	31
	<b>UELC318-308D1W3</b>						UEL318-308D1W3	C318D1	
95 3 5/8	<b>UELC319D1W3</b>	240	72	4	122.3	38.9	<b>UEL319D1W3</b>	<b>C319D1</b>	17
3 11/16	<b>UELC319-310D1W3</b>	9.4488	2 53/64	0.157	4.815	1.531	UEL319-310D1W3	C319D1	37
3 1/16	<b>UELC319-311D1W3</b>						UEL319-311D1W3	C319D1	
3 3/4	<b>UELC319-312D1W3</b>						UEL319-312D1W3	C319D1	
100 3 13/16	<b>UELC320D1W3</b>	260	75	4	128.6	50	<b>UEL320D1W3</b>	<b>C320D1</b>	22
3 7/8	<b>UELC320-313D1W3</b>	10.2362	2 61/64	0.157	5.063	1.969	UEL320-313D1W3	C320D1	49
3 15/16	<b>UELC320-314D1W3</b>						UEL320-314D1W3	C320D1	
3 15/16	<b>UELC320-315D1W3</b>						UEL320-315D1W3	C320D1	
4	<b>UELC320-400D1W3</b>						UEL320-400D1W3	C320D1	
105	<b>UELC321D1W3</b>	260	75	4	139.7	48.4	<b>UEL321D1W3</b>	<b>C321D1</b>	21
110	<b>UELC322D1W3</b>	300	80	5	141.3	49.2	<b>UEL322D1W3</b>	<b>C322D1</b>	31

**Note (1)** These numbers indicate relubricatable type. If maintenance free type is needed, please order without suffix "D1".

**Remarks** Please refer to page **A21** for size of grease fitting.



## Pillow block unit, cast housing Adapter type

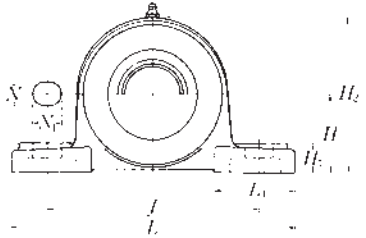
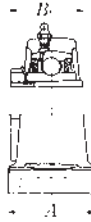
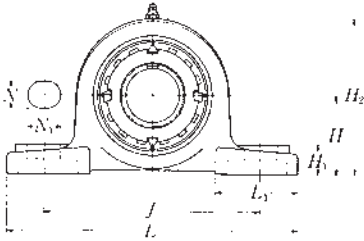

### Pressed steel dust cover type

Open end **Z-UKP...D1**

Closed end **ZM-UKP...D1**

Shaft dia. mm inch	Unit number <sup>(1)</sup> / <sub>(2)</sub> / <sub>(3)</sub>	Nominal dimensions										Bolt size mm inch	Bearing number
		H	L	J	A	N	N <sub>1</sub>	H <sub>1</sub>	H <sub>2</sub>	L <sub>1</sub>	B <sub>1</sub>		
20 ¾	UKP205D1;H2305X	36.5	140	105	38	13	16	15	71	42	35	M10	UK205D1;H2305X
	UKP205D1;HE2305	1 7/16	5 1/2	4 1/8	1 1/2	1/2	5/8	19/32	2 25/32	1 21/32	1.378	3/8	UK205D1;HE2305
25 7/8	UKP206D1;H2306X	42.9	165	121	48	17	20	17	83	54	38	M14	UK206D1;H2306X
	UKP206D1;HS2306	1 11/16	6 1/2	4 3/4	1 7/8	2 1/32	25/32	2 1/32	3 9/32	2 1/8	1.496	1/2	UK206D1;HS2306
1 1 1/8	UKP206D1;HE2306X												UK206D1;HE2306X
	UKP206D1;HS2306X												UK206D1;HS2306X
30 1 1/8	UKP207D1;H2307X	47.6	167	127	48	17	20	18	93	54	43	M14	UK207D1;H2307X
	UKP207D1;HS2307	1 7/8	6 9/16	5	1 7/8	2 1/32	25/32	2 3/32	3 21/32	2 1/8	1.693	1/2	UK207D1;HS2307
35 1 1/4 1 3/8	UKP208D1;H2308X	49.2	184	137	54	17	20	18	98	52	46	M14	UK208D1;H2308X
	UKP208D1;HE2308X	1 15/16	7 1/4	5 13/32	2 1/8	2 1/32	25/32	2 3/32	3 27/32	2 1/16	1.811	1/2	UK208D1;HE2308X
1 3/8	UKP208D1;HS2308X												UK208D1;HS2308X
	UKP208D1;HS2308X												UK208D1;HS2308X
40 1 7/16 1 1/2	UKP209D1;H2309X	54	190	146	54	17	20	20	106	60	50	M14	UK209D1;H2309X
	UKP209D1;HA2309	2 1/8	7 15/32	5 3/4	2 1/8	2 1/32	25/32	2 5/32	4 3/16	2 3/8	1.969	1/2	UK209D1;HA2309
1 1/2	UKP209D1;HE2309X												UK209D1;HE2309X
	UKP209D1;HS2309X												UK209D1;HS2309X
45 1 5/8 1 11/16	UKP210D1;H2310X	57.2	206	159	60	20	23	21	114	65	55	M16	UK210D1;H2310X
	UKP210D1;HS2310	2 1/4	8 1/8	6 1/4	2 3/8	25/32	29/32	1 13/16	4 1/2	2 9/16	2.165	5/8	UK210D1;HS2310
1 1/4	UKP210D1;HA2310												UK210D1;HA2310
	UKP210D1;HE2310X												UK210D1;HE2310X
50 1 7/8 1 5/16	UKP211D1;H2311X	63.5	219	171	60	20	23	23	126	65	59	M16	UK211D1;H2311X
	UKP211D1;HS2311	2 1/2	8 3/8	6 29/32	2 3/8	25/32	29/32	2 9/32	4 31/32	2 9/16	2.323	5/8	UK211D1;HS2311
1 5/16	UKP211D1;HA2311												UK211D1;HA2311
	UKP211D1;HE2311XY												UK211D1;HE2311XY
55 2 1/8	UKP212D1;H2312X	69.8	241	184	70	20	23	25	138	70	62	M16	UK212D1;H2312X
	UKP212D1;HS2312	2 3/4	9 1/2	7 1/4	2 3/4	25/32	29/32	3 1/32	5 1/16	2 3/4	2.441	5/8	UK212D1;HS2312

Notes (1) These numbers indicate retubricatable type. If maintenance free type is needed, please order without suffix "D1".

(2) Adapter number with suffix "X" means a narrow slot type adapter sleeve.

In this case the lock washer with the straight inner prong should be used.

(3) For HE2311XY, screw thread pitch different from the standard is applied, because of the thin thread section of sleeve.

To distinguish it, a suffix "Y" is added.

Remarks Please refer to page A21 for size of grease fitting.

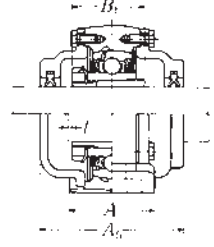
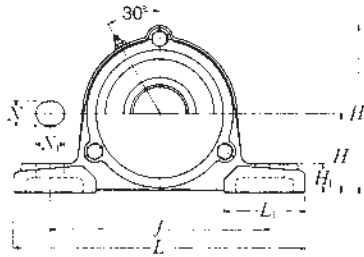

**Cast dust cover type**  
 Open end **C-UKP...D1**  
 Closed end **CM-UKP...D1**

Housing number	Unit number pressed steel dust cover type	Unit number cast dust cover type	Nominal dimensions				Mass of unit		
			<i>t</i> max.	<i>A</i> <sub>4</sub> mm	<i>H</i> <sub>3</sub> inch	<i>A</i> <sub>5</sub> mm	kg lb		
P205D1	Z(ZM)-UKP205D1;H2305X	C(CM)-UKP205D1;H2305X	2	48	76	70	0.8	0.9	1.2
P205D1	Z(ZM)-UKP205ED1;HE2305	C(CM)-UKP205ED1;HE2305	5/64	1 <sup>29</sup> / <sub>32</sub>	3	2 <sup>3</sup> / <sub>4</sub>	1.8	2.0	2.6
P206D1	Z(ZM)-UKP206D1;H2306X	C(CM)-UKP206D1;H2306X	2	53	88	75	1.4	1.5	1.8
P206D1	Z(ZM)-UKP206SD1;HS2306	C(CM)-UKP206SD1;HS2306	5/64	2 <sup>3</sup> / <sub>32</sub>	3 <sup>15</sup> / <sub>32</sub>	2 <sup>15</sup> / <sub>16</sub>	3.1	3.3	4.0
P206D1	Z(ZM)-UKP206ED1;HE2306X	C(CM)-UKP206ED1;HE2306X							
P207D1	Z(ZM)-UKP207D1;H2307X	C(CM)-UKP207D1;H2307X	3	60	99	80	1.7	1.8	2.1
P207D1	Z(ZM)-UKP207SD1;HS2307	C(CM)-UKP207SD1;HS2307	1/8	2 <sup>3</sup> / <sub>8</sub>	3 <sup>29</sup> / <sub>32</sub>	3 <sup>3</sup> / <sub>32</sub>	3.7	4.0	4.6
P208D1	Z(ZM)-UKP208D1;H2308X	C(CM)-UKP208D1;H2308X	3	69	105	90	2.0	2.2	2.8
P208D1	Z(ZM)-UKP208ED1;HE2308X	C(CM)-UKP208ED1;HE2308X	1/8	2 <sup>23</sup> / <sub>32</sub>	4 <sup>1</sup> / <sub>8</sub>	3 <sup>11</sup> / <sub>32</sub>	4.4	4.9	6.2
P208D1	Z(ZM)-UKP208SD1;HS2308X	C(CM)-UKP208SD1;HS2308X							
P209D1	Z(ZM)-UKP209D1;H2309X	C(CM)-UKP209D1;H2309X	3	69	113	95	2.3	2.5	3.3
P209D1	Z(ZM)-UKP209AD1;HA2309	C(CM)-UKP209AD1;HA2309							
P209D1	Z(ZM)-UKP209ED1;HE2309X	C(CM)-UKP209ED1;HE2309X	1/8	2 <sup>23</sup> / <sub>32</sub>	4 <sup>7</sup> / <sub>16</sub>	3 <sup>3</sup> / <sub>4</sub>	5.1	5.5	7.3
P209D1	Z(ZM)-UKP209SD1;HS2309X	C(CM)-UKP209SD1;HS2309X							
P210D1	Z(ZM)-UKP210D1;H2310X	C(CM)-UKP210D1;H2310X	3	76	119	100	2.9	3.0	3.9
P210D1	Z(ZM)-UKP210SD1;HS2310	C(CM)-UKP210SD1;HS2310							
P210D1	Z(ZM)-UKP210AD1;HA2310	C(CM)-UKP210AD1;HA2310	1/8	3	4 <sup>1</sup> / <sub>16</sub>	3 <sup>15</sup> / <sub>16</sub>	6.4	6.6	8.6
P210D1	Z(ZM)-UKP210ED1;HE2310X	C(CM)-UKP210ED1;HE2310X							
P211D1	Z(ZM)-UKP211D1;H2311X	C(CM)-UKP211D1;H2311X	4	77	130	100	3.6	3.7	4.8
P211D1	Z(ZM)-UKP211SD1;HS2311	C(CM)-UKP211SD1;HS2311							
P211D1	Z(ZM)-UKP211AD1;HA2311	C(CM)-UKP211AD1;HA2311	5/32	3 <sup>1</sup> / <sub>32</sub>	5 <sup>1</sup> / <sub>8</sub>	3 <sup>5</sup> / <sub>16</sub>	7.9	8.2	11
P211D1	Z(ZM)-UKP211ED1;HE2311XY	C(CM)-UKP211ED1;HE2311XY							
P212D1	Z(ZM)-UKP212D1;H2312X	C(CM)-UKP212D1;H2312X	4	89	143	115	4.7	5.1	6.2
P212D1	Z(ZM)-UKP212SD1;HS2312	C(CM)-UKP212SD1;HS2312	5/32	3 <sup>1</sup> / <sub>2</sub>	5 <sup>5</sup> / <sub>8</sub>	4 <sup>7</sup> / <sub>32</sub>	10	11	14



## Pillow block unit, cast housing Adapter type

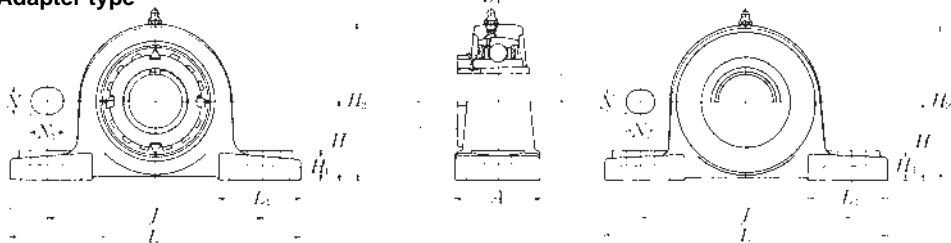

### Pressed steel dust cover type

Open end **Z-UKP...D1**

Closed end **ZM-UKP...D1**

Shaft dia. mm inch	Unit number <sup>(1)</sup> ( <sup>2</sup> )	Nominal dimensions										Bolt size mm inch	Bearing number
		mm inch											
		H	L	J	A	N	N <sub>1</sub>	H <sub>1</sub>	H <sub>2</sub>	L <sub>1</sub>	B <sub>1</sub>		
60 2 3/16 2 1/4 2 3/8	UKP213D1;H2313X UKP213D1;HA2313 UKP213D1;HE2313X UKP213D1;HS2313X	76.2	265	203	70	25	28	27	151	77	65	M20	UK213D1;H2313X UK213D1;HA2313 UK213D1;HE2313X UK213D1;HS2313X
65 2 7/16 2 1/2	UKP215D1;H2315X UKP215D1;HA2315 UKP215D1;HE2315X	82.6	275	217	74	25	28	28	163	80	73	M20	UK215D1;H2315X UK215D1;HA2315 UK215D1;HE2315X
70 2 11/16 2 3/4	UKP216D1;H2316X UKP216D1;HA2316 UKP216D1;HE2316X	88.9	292	232	78	25	28	30	175	85	78	M20	UK216D1;H2316X UK216D1;HA2316 UK216D1;HE2316X
75 2 15/16 3	UKP217D1;H2317X UKP217D1;HA2317X UKP217D1;HE2317X	95.2	310	247	83	25	28	32	187	85	82	M20	UK217D1;H2317X UK217D1;HA2317X UK217D1;HE2317X
80 3 1/16	UKP218D1;H2318X UKP218D1;HA2318X	101.6	327	262	88	27	30	33	200	90	86	M22	UK218D1;H2318X UK218D1;HA2318X

Notes <sup>(1)</sup> These numbers indicate relubricatable type. If maintenance free type is needed, please order without suffix "D1".

<sup>(2)</sup> Adapter number with suffix "X" means a narrow slot type adapter sleeve.

In this case the lock washer with the straight inner prong should be used.

Remarks Please refer to page A21 for size of grease fitting.

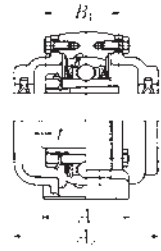
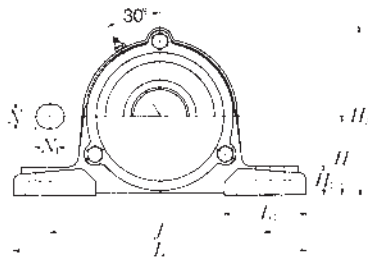

**Cast dust cover type**  
 Open end **C-UKP...D1**  
 Closed end **CM-UKP...D1**

Housing number	Unit number pressed steel dust cover type	Unit number cast dust cover type	Nominal dimensions				Mass of unit		
			<i>t</i> max.	<i>A</i> <sub>4</sub>	<i>H</i> <sub>3</sub>	<i>A</i> <sub>5</sub>	UKP	Z(ZM)	C(CM)
P213D1	Z(ZM)-UKP213D1;H2313X	C(CM)-UKP213D1;H2313X	4	91	155	120	5.7	5.9	7.6
P213D1	Z(ZM)-UKP213AD1;HA2313	C(CM)-UKP213AD1;HA2313							
P213D1	Z(ZM)-UKP213ED1;HE2313X	C(CM)-UKP213ED1;HE2313X	$\frac{5}{32}$	$3\frac{19}{32}$	$6\frac{3}{32}$	$4\frac{23}{32}$	13	13	17
P213D1	Z(ZM)-UKP213SD1;HS2313X	C(CM)-UKP213SD1;HS2313X							
P215D1	–	C(CM)-UKP215D1;H2315X	4	–	168	135	7.5	–	10
P215D1	–	C(CM)-UKP215AD1;HA2315	$\frac{5}{32}$	–	$6\frac{5}{8}$	$5\frac{5}{16}$	17	–	22
P215D1	–	C(CM)-UKP215ED1;HE2315X							
P216D1	–	C(CM)-UKP216D1;H2316X	4	–	181	145	9.2	–	12
P216D1	–	C(CM)-UKP216AD1;HA2316	$\frac{5}{32}$	–	$7\frac{1}{8}$	$5\frac{23}{32}$	20	–	26
P216D1	–	C(CM)-UKP216ED1;HE2316X							
P217D1	–	C(CM)-UKP217D1;H2317X	5	–	191	155	11	–	14
P217D1	–	C(CM)-UKP217AD1;HA2317X	$\frac{13}{64}$	–	$7\frac{17}{32}$	$6\frac{3}{32}$	24	–	31
P217D1	–	C(CM)-UKP217ED1;HE2317X							
P218D1	–	C(CM)-UKP218D1;H2318X	5	–	204	165	13	–	16
P218D1	–	C(CM)-UKP218AD1;HA2318X	$\frac{13}{64}$	–	$8\frac{1}{2}$	$6\frac{1}{2}$	29	–	35

## Pillow block unit, cast housing Adapter type

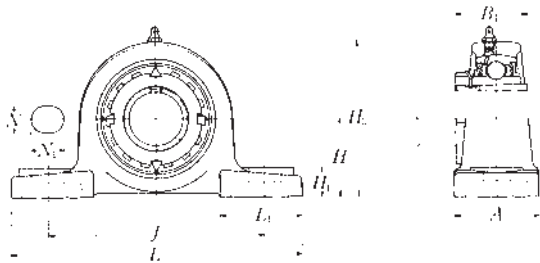

Shaft dia. mm inch	Unit number <sup>(1)</sup> / <sub>(2)</sub> / <sub>(3)</sub>	Nominal dimensions										Bolt size mm inch
		mm inch										
		H	L	J	A	N	N <sub>1</sub>	H <sub>1</sub>	H <sub>2</sub>	L <sub>1</sub>	B <sub>1</sub>	
20 3/4	UKP305D1;H2305X UKP305D1;HE2305	45 1 49/64	175 6 7/8	132 5 3/16	45 1 25/32	17 2 1/32	20 2 5/32	15 1 9/32	85 3 11/32	54 2 1/8	35 1.378	M14 1/2
25 7/8 1	UKP306D1;H2306X UKP306D1;HS2306 UKP306D1;HE2306X	50 1 31/32	180 7 3/32	140 5 1/2	50 1 31/32	17 2 1/32	20 2 5/32	18 2 3/32	95 3 3/4	54 2 1/8	38 1.496	M14 1/2
30 1 1/8	UKP307D1;H2307X UKP307D1;HS2307	56 2 13/64	210 8 9/32	160 6 5/16	56 2 7/32	17 2 1/32	25 3 1/32	20 2 5/32	106 4 3/16	60 2 3/8	43 1.693	M14 1/2
35 1 1/4 1 3/8	UKP308D1;H2308X UKP308D1;HE2308X UKP308D1;HS2308X	60 2 23/64	220 8 21/32	170 6 11/16	60 2 3/8	17 2 1/32	27 1 1/16	22 7/8	116 4 9/16	60 2 3/8	46 1.811	M14 1/2
40 1 7/16 1 1/2 1 5/8	UKP309D1;H2309X UKP309D1;HA2309 UKP309D1;HE2309X UKP309D1;HS2309X	67 2 41/64	245 9 21/32	190 7 15/32	67 2 5/8	20 2 5/32	30 1 3/16	24 1 5/16	129 5 3/32	65 2 9/16	50 1.969	M16 5/8
45 1 5/8 1 11/16 1 3/4	UKP310D1;H2310X UKP310D1;HS2310 UKP310D1;HA2310 UKP310D1;HE2310X	75 2 61/64	275 10 13/16	212 8 11/32	75 2 15/16	20 2 5/32	35 1 3/8	27 1 1/16	143 5 5/8	75 2 15/16	55 2.165	M16 5/8
50 1 7/8 1 13/16 2	UKP311D1;H2311X UKP311D1;HS2311 UKP311D1;HA2311 UKP311D1;HE2311XY	80 3 3/32	310 12 7/32	236 9 9/32	80 3 3/32	20 2 5/32	38 1 1/2	30 1 3/16	154 6 1/16	85 3 11/32	59 2.323	M16 5/8
55 2 1/8	UKP312D1;H2312X UKP312D1;HS2312	85 3 11/32	330 13	250 9 27/32	85 3 11/32	25 3 1/32	38 1 1/2	32 1 1/4	165 6 1/2	95 3 3/4	62 2.441	M20 3/4

Notes (1) These numbers indicate relubricatable type. If maintenance free type is needed, please order without suffix "D1".

(2) Adapter number with suffix "X" means a narrow slot type adapter sleeve.

In this case the lock washer with the straight inner prong should be used.

(3) For HE2311XY, screw thread pitch different from the standard is applied, because of the thin thread section of sleeve.

To distinguish it, a suffix "Y" is added.

Remarks Please refer to page A21 for size of grease fitting.

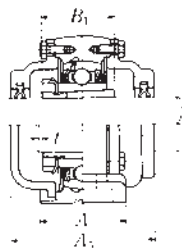
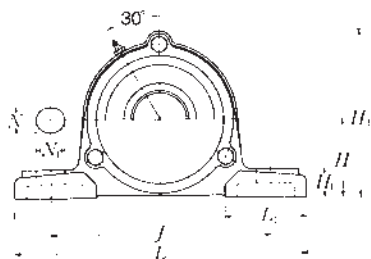

**Cast dust cover type**  
 Open end **C-UKP...D1**  
 Closed end **CM-UKP...D1**

Bearing number	Housing number	Unit number cast dust cover type	Nominal dimensions			Mass of unit	
			<i>t</i> max.	<i>H</i> <sub>3</sub>	<i>A</i> <sub>3</sub>	UKP	C(CM)
UK305D1;H2305X UK305D1;HE2305	P305D1 P305D1	<b>C(CM)-UKP305D1;H2305X</b> <b>C(CM)-UKP305ED1;HE2305</b>	2 $\frac{5}{64}$	91 $3\frac{19}{32}$	80 $3\frac{5}{32}$	1.4 3.1	1.9 4.2
UK306D1;H2306X UK306D1;HS2306 UK306D1;HE2306X	P306D1 P306D1 P306D1	<b>C(CM)-UKP306D1;H2306X</b> <b>C(CM)-UKP306SD1;HS2306</b> <b>C(CM)-UKP306ED1;HE2306X</b>	2 $\frac{5}{64}$	105 $4\frac{1}{8}$	85 $3\frac{11}{32}$	1.8 4.0	2.6 5.7
UK307D1;H2307X UK307D1;HS2307	P307D1 P307D1	<b>C(CM)-UKP307D1;H2307X</b> <b>C(CM)-UKP307SD1;HS2307</b>	3 $\frac{1}{8}$	115 $4\frac{7}{32}$	95 $3\frac{3}{4}$	2.6 5.7	3.3 7.3
UK308D1;H2308X UK308D1;HE2308X UK308D1;HS2308X	P308D1 P308D1 P308D1	<b>C(CM)-UKP308D1;H2308X</b> <b>C(CM)-UKP308ED1;HE2308X</b> <b>C(CM)-UKP308SD1;HS2308X</b>	3 $\frac{1}{8}$	125 $4\frac{29}{32}$	105 $4\frac{1}{8}$	3.1 6.8	4.2 9.3
UK309D1;H2309X UK309D1;HA2309 UK309D1;HE2309X UK309D1;HS2309X	P309D1 P309D1 P309D1 P309D1	<b>C(CM)-UKP309D1;H2309X</b> <b>C(CM)-UKP309AD1;HA2309</b> <b>C(CM)-UKP309ED1;HE2309X</b> <b>C(CM)-UKP309SD1;HS2309X</b>	3 $\frac{1}{8}$	140 $5\frac{1}{2}$	110 $4\frac{11}{32}$	4.1 9.0	5.6 12
UK310D1;H2310X UK310D1;HS2310 UK310D1;HA2310 UK310D1;HE2310X	P310D1 P310D1 P310D1 P310D1	<b>C(CM)-UKP310D1;H2310X</b> <b>C(CM)-UKP310SD1;HS2310</b> <b>C(CM)-UKP310AD1;HA2310</b> <b>C(CM)-UKP310ED1;HE2310X</b>	3 $\frac{1}{8}$	156 $6\frac{3}{32}$	120 $4\frac{23}{32}$	5.6 12	7.2 16
UK311D1;H2311X UK311D1;HS2311 UK311D1;HA2311 UK311D1;HE2311XY	P311D1 P311D1 P311D1 P311D1	<b>C(CM)-UKP311D1;H2311X</b> <b>C(CM)-UKP311SD1;HS2311</b> <b>C(CM)-UKP311AD1;HA2311</b> <b>C(CM)-UKP311ED1;HE2311XY</b>	4 $\frac{5}{32}$	166 $6\frac{7}{32}$	125 $4\frac{29}{32}$	7.3 16	9.0 20
UK312D1;H2312X UK312D1;HS2312	P312D1 P312D1	<b>C(CM)-UKP312D1;H2312X</b> <b>C(CM)-UKP312SD1;HS2312</b>	4 $\frac{5}{32}$	179 $7\frac{1}{16}$	135 $5\frac{5}{16}$	9.3 21	11 24

## Pillow block unit, cast housing Adapter type

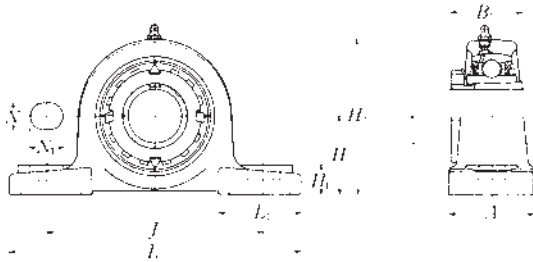

Shaft dia. mm inch	Unit number <sup>(1)</sup> ( <sup>2</sup> )	Nominal dimensions										Bolt size mm inch
		mm inch										
		H	L	J	A	N	N <sub>1</sub>	H <sub>1</sub>	H <sub>2</sub>	L <sub>1</sub>	B <sub>1</sub>	
60 2 3/16 2 1/4 2 3/8	UKP313D1;H2313X UKP313D1;HA2313 UKP313D1;HE2313X UKP313D1;HS2313X	90 3 5/8	340 13 3/8	260 10 1/4	90 3 17/32	25 3 1/32	38 1 1/2	33 1 5/16	176 6 15/16	105 4 1/8	65 2.559	M20 3/4
65 2 7/16 2 1/2	UKP315D1;H2315X UKP315D1;HA2315 UKP315D1;HE2315X	100 3 15/16	380 14 31/32	290 11 13/32	100 3 15/16	27 1 1/16	40 1 9/16	35 1 3/8	198 7 25/32	110 4 11/32	73 2.874	M22 7/8
70 2 11/16 2 3/4	UKP316D1;H2316X UKP316D1;HA2316 UKP316D1;HE2316X	106 4 11/64	400 15 3/4	300 11 13/16	110 4 11/32	27 1 1/16	40 1 9/16	40 1 9/16	210 8 9/32	110 4 11/32	78 3.071	M22 7/8
75 2 5/16 3	UKP317D1;H2317X UKP317D1;HA2317X UKP317D1;HE2317X	112 4 13/32	420 16 17/32	320 12 9/32	110 4 11/32	33 1 5/16	45 1 25/32	40 1 9/16	220 8 21/32	120 4 23/32	82 3.228	M27 1
80 3 3/16	UKP318D1;H2318X UKP318D1;HA2318X	118 4 41/64	430 16 15/16	330 13	110 4 11/32	33 1 5/16	45 1 25/32	45 1 25/32	235 9 1/4	120 4 23/32	86 3.386	M27 1
85 3 1/4	UKP319D1;H2319X UKP319D1;HE2319X	125 4 59/64	470 18 1/2	360 14 3/16	120 4 23/32	35 1 13/32	50 1 31/32	45 1 25/32	250 9 27/32	125 4 29/32	90 3.543	M30 1 1/8
90 3 7/16 3 1/2	UKP320D1;H2320X UKP320D1;HA2320 UKP320D1;HE2320X	140 5 33/64	490 19 3/32	380 14 31/32	120 4 23/32	36 1 13/32	50 1 31/32	50 1 31/32	275 10 13/16	130 5 1/8	97 3.819	M30 1 1/8
100	UKP322D1;H2322X	150	520	400	140	40	55	55	300	135	105	M33
110	UKP324D1;H2324X	160	570	450	140	40	55	65	320	140	112	M33
115	UKP326D1;H2326	180	600	480	140	40	55	75	355	140	121	M33
125	UKP328D1;H2328	200	620	500	140	40	55	75	390	140	131	M33

Notes <sup>(1)</sup> These numbers indicate relubricatable type. If maintenance free type is needed, please order without suffix "D1".

<sup>(2)</sup> Adapter number with suffix "X" means a narrow slot type adapter sleeve.

In this case the lock washer with the straight inner prong should be used.

Remarks Please refer to page A21 for size of grease fitting.

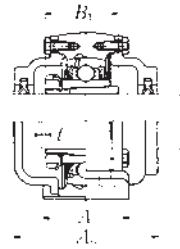
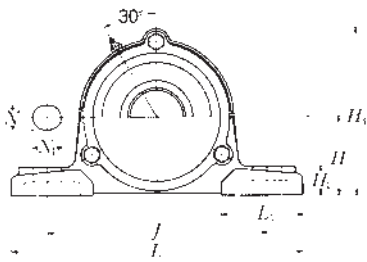

**Cast dust cover type**  
 Open end **C-UKP...D1**  
 Closed end **CM-UKP...D1**

Bearing number	Housing number	Unit number cast dust cover type	Nominal dimensions			Mass of unit	
			<i>t</i> max.	<i>H</i> <sub>3</sub>	<i>A</i> <sub>3</sub>	UKP	C(CM)
UK313D1;H2313X UK313D1;HA2313 UK313D1;HE2313X UK313D1;HS2313X	P313D1 P313D1 P313D1 P313D1	<b>C(CM)-UKP313D1;H2313X</b> <b>C(CM)-UKP313AD1;HA2313</b> <b>C(CM)-UKP313ED1;HE2313X</b> <b>C(CM)-UKP313SD1;HS2313X</b>	4  $\frac{5}{32}$	190  $7\frac{15}{32}$	140  $5\frac{1}{2}$	10  22	12  26
UK315D1;H2315X UK315D1;HA2315 UK315D1;HE2315X	P315D1 P315D1 P315D1	<b>C(CM)-UKP315D1;H2315X</b> <b>C(CM)-UKP315AD1;HA2315</b> <b>C(CM)-UKP315ED1;HE2315X</b>	4  $\frac{5}{32}$	210  $8\frac{9}{32}$	150  $5\frac{29}{32}$	14  31	18  40
UK316D1;H2316X UK316D1;HA2316 UK316D1;HE2316X	P316D1 P316D1 P316D1	<b>C(CM)-UKP316D1;H2316X</b> <b>C(CM)-UKP316AD1;HA2316</b> <b>C(CM)-UKP316ED1;HE2316X</b>	4  $\frac{5}{32}$	221  $8\frac{11}{16}$	155  $6\frac{3}{32}$	17  37	21  46
UK317D1;H2317X UK317D1;HA2317X UK317D1;HE2317X	P317D1 P317D1 P317D1	<b>C(CM)-UKP317D1;H2317X</b> <b>C(CM)-UKP317AD1;HA2317X</b> <b>C(CM)-UKP317ED1;HE2317X</b>	5  $\frac{13}{64}$	235  $9\frac{1}{4}$	170  $6\frac{11}{16}$	19  42	24  53
UK318D1;H2318X UK318D1;HA2318X	P318D1 P318D1	<b>C(CM)-UKP318D1;H2318X</b> <b>C(CM)-UKP318AD1;HA2318X</b>	5  $\frac{13}{64}$	246  $9\frac{1}{16}$	170  $6\frac{11}{16}$	22  49	28  62
UK319D1;H2319X UK319D1;HE2319X	P319D1 P319D1	<b>C(CM)-UKP319D1;H2319X</b> <b>C(CM)-UKP319ED1;HE2319X</b>	5  $\frac{13}{64}$	258  $10\frac{5}{32}$	180  $7\frac{3}{32}$	27  60	33  73
UK320D1;H2320X UK320D1;HA2320 UK320D1;HE2320X	P320D1 P320D1 P320D1	<b>C(CM)-UKP320D1;H2320X</b> <b>C(CM)-UKP320AD1;HA2320</b> <b>C(CM)-UKP320ED1;HE2320X</b>	5  $\frac{13}{64}$	283  $11\frac{5}{32}$	190  $7\frac{15}{32}$	33  73	40  88
UK322D1;H2322X	P322D1	<b>C(CM)-UKP322D1;H2322X</b>	5	313	200	43	53
UK324D1;H2324X	P324D1	<b>C(CM)-UKP324D1;H2324X</b>	5	335	215	50	67
UK326D1;H2326	P326D1	<b>C(CM)-UKP326D1;H2326</b>	6	375	225	69	86
UK328D1;H2328	P328D1	<b>C(CM)-UKP328D1;H2328</b>	6	407	235	84	101

## Pillow block unit, cast housing Adapter type

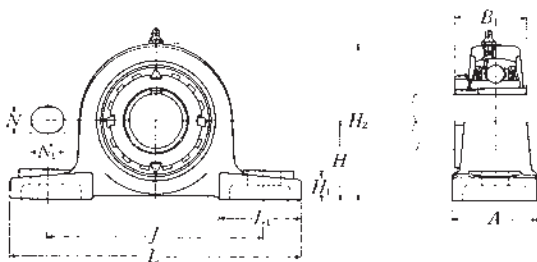

Shaft dia.  mm inch	Unit number <sup>(1)</sup> / <sub>(2)</sub> / <sub>(3)</sub>	Nominal dimensions										Bolt size  mm inch
		mm inch										
		H	L	J	A	N	N <sub>1</sub>	H <sub>1</sub>	H <sub>2</sub>	L <sub>1</sub>	B <sub>1</sub>	
20  3/4	UKPX05D1;H2305X	44.4	159	119	51	17	20	18	85	50	35	M14  1/2
	UKPX05D1;HE2305	1 3/4	6 1/4	4 11/16	2	2 1/32	2 5/32	2 9/32	3 1/2	1 31/32	1.378	
25  7/8 1	UKPX06D1;H2306X	47.6	175	127	57	17	20	20	93	54	38	M14  1/2
	UKPX06D1;HS2306	1 7/8	6 7/8	5	2 1/4	2 1/32	2 5/32	2 5/32	3 21/32	2 1/8	1.496	
30  1 1/8	UKPX07D1;H2307X	54	203	144	57	17	20	21	105	60	43	M14  1/2
	UKPX07D1;HS2307	2 1/8	8	5 21/32	2 1/4	2 1/32	2 5/32	1 1/16	4 1/8	2 3/8	1.693	
35  1 1/4 1 3/8	UKPX08D1;H2308X	58.7	222	156	67	20	23	26	111	65	46	M16  5/8
	UKPX08D1;HE2308X	2 5/16	8 3/4	6 5/32	2 5/8	2 5/32	2 9/32	1 1/32	4 3/8	2 9/16	1.811	
40  1 7/16 1 1/2 1 5/8	UKPX09D1;H2309X	58.7	222	156	67	20	23	26	116	65	50	M16  5/8
	UKPX09D1;HE2309X	2 5/16	8 3/4	6 5/32	2 5/8	2 5/32	2 9/32	1 1/32	4 9/16	2 9/16	1.969	
45  1 5/8 1 11/16 1 3/4	UKPX10D1;H2310X	63.5	241	171	73	20	23	27	126	70	55	M16  5/8
	UKPX10D1;HE2310X	2 1/2	9 1/2	6 23/32	2 7/8	2 5/32	2 9/32	1 1/16	4 31/32	2 3/4	2.165	
50  1 7/8 1 15/16 2	UKPX11D1;H2311X	69.8	260	184	79	25	28	30	137	75	59	M20  3/4
	UKPX11D1;HE2311X	2 3/4	10 1/4	7 1/4	3 1/8	3 1/32	1 3/32	1 3/16	5 13/32	2 15/16	2.323	
55  2 1/8	UKPX12D1;H2312X	76.2	286	203	83	25	28	33	151	80	62	M20  3/4
	UKPX12D1;HE2312	3	11 1/4	8	3 3/32	3 1/32	1 3/32	1 3/16	5 15/16	3 3/32	2.441	

Notes (1) These numbers indicate relubricatable type. If maintenance free type is needed, please order without suffix "D1".

(2) Adapter number with suffix "X" means a narrow slot type adapter sleeve.

In this case the lock washer with the straight inner prong should be used.

(3) For HE2311XY, screw thread pitch different from the standard is applied, because of the thin thread section of sleeve.

To distinguish it, a suffix "Y" is added.

Remarks Please refer to page A21 for size of grease fitting.

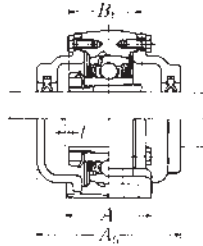
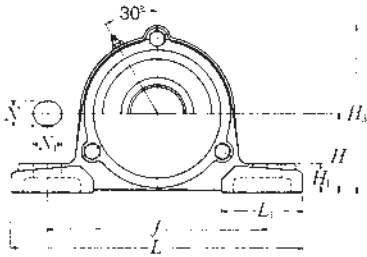

**Cast dust cover type**

Open end **C-UKP...D1**

Closed end **CM-UKP...D1**

Bearing number	Housing number	Unit number cast dust cover type	Nominal dimensions			Mass of unit	
			<i>t</i>	<i>H</i> <sub>3</sub>	<i>A</i> <sub>5</sub>	kg	lb
			max.			UKP	C(CM)
UKX05D1;H2305X	PX05D1	C(CM)-UKPX05D1;H2305X	2	89	75	1.4	1.8
UKX05D1;HE2305	PX05D1	C(CM)-UKPX05ED1;HE2305	$\frac{5}{64}$	$3\frac{1}{2}$	$2\frac{15}{16}$	3.1	4.0
UKX06D1;H2306X	PX06D1	C(CM)-UKPX06D1;H2306X	2	99	80	1.7	2.2
UKX06D1;HS2306	PX06D1	C(CM)-UKPX06SD1;HS2306	$\frac{5}{64}$	$3\frac{29}{32}$	$3\frac{5}{32}$	3.7	4.9
UKX06D1;HE2306X	PX06D1	C(CM)-UKPX06ED1;HE2306X					
UKX07D1;H2307X	PX07D1	C(CM)-UKPX07D1;H2307X	3	110	90	2.5	3.3
UKX07D1;HS2307	PX07D1	C(CM)-UKPX07SD1;HS2307	$\frac{1}{8}$	$4\frac{11}{32}$	$3\frac{17}{32}$	5.5	7.3
UKX08D1;H2308X	PX08D1	C(CM)-UKPX08D1;H2308X	3	118	95	3.2	4.1
UKX08D1;HE2308X	PX08D1	C(CM)-UKPX08ED1;HE2308X	$\frac{1}{8}$	$4\frac{41}{64}$	$3\frac{3}{4}$	7.1	9.0
UKX08D1;HS2308X	PX08D1	C(CM)-UKPX08SD1;HS2308X					
UKX09D1;H2309X	PX09D1	C(CM)-UKPX09D1;H2309X	3	120	100	3.3	4.3
UKX09D1;HA2309	PX09D1	C(CM)-UKPX09AD1;HA2309					
UKX09D1;HE2309X	PX09D1	C(CM)-UKPX09ED1;HE2309X	$\frac{1}{8}$	$4\frac{23}{32}$	$3\frac{15}{16}$	7.3	9.5
UKX09D1;HS2309X	PX09D1	C(CM)-UKPX09SD1;HS2309X					
UKX10D1;H2310X	PX10D1	C(CM)-UKPX10D1;H2310X	3	130	100	4.2	5.4
UKX10D1;HS2310	PX10D1	C(CM)-UKPX10SD1;HS2310					
UKX10D1;HA2310	PX10D1	C(CM)-UKPX10AD1;HA2310	$\frac{1}{8}$	$5\frac{1}{8}$	$3\frac{15}{16}$	9.3	12
UKX10D1;HE2310X	PX10D1	C(CM)-UKPX10ED1;HE2310X					
UKX11D1;H2311X	PX11D1	C(CM)-UKPX11D1;H2311X	4	144	115	5.3	6.8
UKX11D1;HS2311	PX11D1	C(CM)-UKPX11SD1;HS2311					
UKX11D1;HA2311	PX11D1	C(CM)-UKPX11AD1;HA2311	$\frac{5}{32}$	$5\frac{21}{32}$	$4\frac{17}{32}$	12	15
UKX11D1;HE2311XY	PX11D1	C(CM)-UKPX11ED1;HE2311XY					
UKX12D1;H2312X	PX12D1	C(CM)-UKPX12D1;H2312X	4	155	120	6.8	8.6
UKX12D1;HS2312	PX12D1	C(CM)-UKPX12SD1;HS2312	$\frac{5}{32}$	$6\frac{3}{32}$	$4\frac{23}{32}$	15	19



## Pillow block unit, cast housing Adapter type

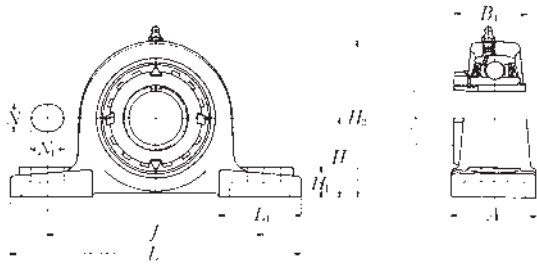

Shaft dia.  mm inch	Unit number <sup>(1)</sup> ( <sup>2</sup> )	Nominal dimensions										Bolt size  mm inch
		mm inch										
		H	L	J	A	N	N <sub>1</sub>	H <sub>1</sub>	H <sub>2</sub>	L <sub>1</sub>	B <sub>1</sub>	
60 2 3/16 2 1/4 2 3/8	UKPX13D1;H2313X UKPX13D1;HA2313 UKPX13D1;HE2313X UKPX13D1;HS2313X	76.2 3	286 11 1/4	203 8	83 3 3/32	25 3 1/32	28 1 1/32	33 1 5/16	154 6 1/16	80 3 5/32	65 2.559	M20 3/4
65 2 7/16 2 1/2	UKPX15D1;H2315X UKPX15D1;HA2315 UKPX15D1;HE2315X	88.9 3 1/2	330 13	229 9 1/32	89 3 1/2	27 1 1/16	30 1 3/16	35 1 3/8	175 6 7/8	95 3 3/4	73 2.874	M22 7/8
70 2 11/16 2 3/4	UKPX16D1;H2316X UKPX16D1;HA2316 UKPX16D1;HE2316X	101.6 4	381 15	283 11 5/32	102 4 1/32	27 1 1/16	30 1 3/16	40 1 9/16	194 7 5/8	110 4 11/32	78 3.071	M22 7/8
75 2 5/16 3	UKPX17D1;H2317X UKPX17D1;HA2317X UKPX17D1;HE2317X	101.6 4	381 15	283 11 5/32	102 4 1/32	27 1 1/16	30 1 3/16	40 1 9/16	200 7 7/8	110 4 1/32	82 3.228	M22 7/8
80 3 3/16	UKPX18D1;H2318X UKPX18D1;HA2318X	101.6 4	381 15	283 11 5/32	111 4 3/8	27 1 1/16	30 1 3/16	40 1 9/16	206 8 1/8	110 4 11/32	86 3.386	M22 7/8
90	UKPX20D1;H2320X	127	432	337	121	33	36	45	244	125	97	M27

Notes <sup>(1)</sup> These numbers indicate relubricatable type. If maintenance free type is needed, please order without suffix "D1".

<sup>(2)</sup> Adapter number with suffix "X" means a narrow slot type adapter sleeve.

In this case the lock washer with the straight inner prong should be used.

Remarks Please refer to page A21 for size of grease fitting.

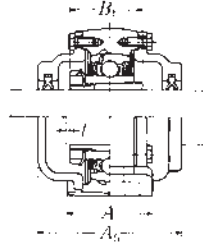
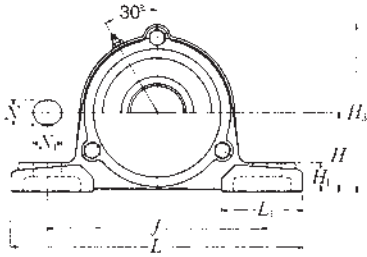

**Cast dust cover type**

Open end **C-UKP...D1**

Closed end **CM-UKP...D1**

Bearing number	Housing number	Unit number cast dust cover type	Nominal dimensions			Mass of unit	
			<i>t</i>	<i>H</i> <sub>5</sub>	<i>A</i> <sub>5</sub>	kg	lb
			max.			UKP	C(CM)
UKX13D1;H2313X	PX13D1	C(CM)-UKPX13D1;H2313X	4	159	135	6.9	9.2
UKX13D1;HA2313	PX13D1	C(CM)-UKPX13AD1;HA2313					
UKX13D1;HE2313X	PX13D1	C(CM)-UKPX13ED1;HE2313X	5/32	6 1/4	5 5/16	15	20
UKX13D1;HS2313X	PX13D1	C(CM)-UKPX13SD1;HS2313X					
UKX15D1;H2315X	PX15D1	C(CM)-UKPX15D1;H2315X	4	181	145	10	13
UKX15D1;HA2315	PX15D1	C(CM)-UKPX15AD1;HA2315					
UKX15D1;HE2315X	PX15D1	C(CM)-UKPX15ED1;HE2315X	5/32	7 1/8	5 23/32	22	29
UKX16D1;H2316X	PX16D1	C(CM)-UKPX16D1;H2316X	4	198	155	14	17
UKX16D1;HA2316	PX16D1	C(CM)-UKPX16AD1;HA2316					
UKX16D1;HE2316X	PX16D1	C(CM)-UKPX16ED1;HE2316X	5/32	7 25/32	6 3/32	31	37
UKX17D1;H2317X	PX17D1	C(CM)-UKPX17D1;H2317X	5	204	165	15	18
UKX17D1;HA2317X	PX17D1	C(CM)-UKPX17AD1;HA2317X					
UKX17D1;HE2317X	PX17D1	C(CM)-UKPX17ED1;HE2317X	13/64	8 1/32	6 1/2	33	40
UKX18D1;H2318X	PX18D1	C(CM)-UKPX18D1;H2318X	5	208	180	16	20
UKX18D1;HA2318X	PX18D1	C(CM)-UKPX18AD1;HA2318	13/64	8 3/16	7 3/32	35	44
UKX20D1;H2320X	PX20D1	C(CM)-UKPX20D1;H2320X	5	244	195	24	28

## Square flanged unit, cast housing Adapter type

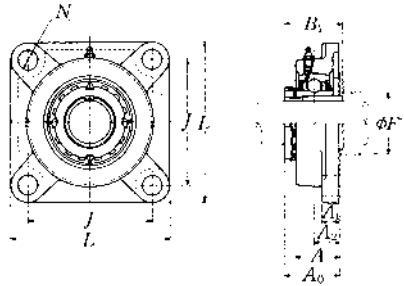

Shaft dia. mm inch	Unit number <sup>(1)</sup> <sup>(2)</sup> <sup>(3)</sup>	Nominal dimensions									Bolt size mm inch	Bearing number
		L	J	A <sub>2</sub>	A <sub>1</sub>	mm inch		A <sub>0</sub>	B <sub>1</sub>	F min.		
20 3/4	UKF205D1;H2305X	95	70	16	13	27	12	35.5	35	30	M10	UK205D1;H2305X
	UKF205D1;HE2305	3 3/4	2 3/4	5/8	1/2	1 1/16	15/32	1 25/64	1.378	1 1/16	3/8	UK205D1;HE2305
25 7/8	UKF206D1;H2306X	108	83	18	13	31	12	39	38	36	M10	UK206D1;H2306X
	UKF206D1;HS2306	4 1/4	3 17/64	45/64	1/2	1 7/32	15/32	1 17/32	1.496	1 19/32	3/8	UK206D1;HS2306
1 1	UKF206D1;HE2306X											UK206D1;HE2306X
30 1 1/8	UKF207D1;H2307X	117	92	19	15	34	14	42.5	43	40	M12	UK207D1;H2307X
	UKF207D1;HS2307	4 19/32	3 5/8	3/4	1 9/32	1 11/32	35/64	1 43/64	1.693	1 9/16	7/16	UK207D1;HS2307
35 1 1/4	UKF208D1;H2308X	130	102	21	15	36	16	46.5	46	46	M14	UK208D1;H2308X
	UKF208D1;HE2308X	5 1/8	4 1/64	53/64	1 9/32	1 13/32	5/8	1 53/64	1.811	1 13/16	1/2	UK208D1;HE2308X
1 3/8	UKF208D1;HS2308X											UK208D1;HS2308X
40 1 7/16	UKF209D1;H2309X	137	105	22	16	38	16	48.5	50	52	M14	UK209D1;H2309X
	UKF209D1;HA2309	5 13/32	4 9/64	55/64	5/8	1 1/2	5/8	1 29/32	1.969	2 1/16	1/2	UK209D1;HA2309
1 1/2	UKF209D1;HE2309X											UK209D1;HE2309X
	UKF209D1;HS2309X											UK209D1;HS2309X
1 5/8												
45 1 5/8	UKF210D1;H2310X	143	111	22	16	40	16	50	55	57	M14	UK210D1;H2310X
	UKF210D1;HS2310	5 5/8	4 3/8	55/64	5/8	1 9/16	5/8	1 31/32	2.165	2 1/4	1/2	UK210D1;HS2310
1 11/16	UKF210D1;HA2310											UK210D1;HA2310
	UKF210D1;HE2310X											UK210D1;HE2310X
1 3/4												
50 1 7/8	UKF211D1;H2311X	162	130	25	18	43	19	54.5	59	64	M16	UK211D1;H2311X
	UKF211D1;HS2311	6 3/8	5 1/8	63/64	23/32	1 11/16	3/4	2 9/64	2.323	2 17/32	5/8	UK211D1;HS2311
1 15/16	UKF211D1;HA2311											UK211D1;HA2311
	UKF211D1;HE2311XY											UK211D1;HE2311XY
2												
55 2 1/8	UKF212D1;H2312X	175	143	29	18	48	19	61	62	69	M16	UK212D1;H2312X
	UKF212D1;HS2312	6 7/8	5 5/8	1 9/64	23/32	1 7/8	3/4	2 13/32	2.441	2 23/32	5/8	UK212D1;HS2312

Notes (1) These numbers indicate relubricatable type. If maintenance free type is needed, please order without suffix "D1".

(2) Adapter number with suffix "X" means a narrow slot type adapter sleeve.  
In this case the lock washer with the straight inner prong should be used.

(3) For HE2311XY, screw thread pitch different from the standard is applied, because of the thin thread section of sleeve.  
To distinguish it, a suffix "Y" is added.

(4) If the inch series housing units with dust cover are ordered with a closed end, the suffixes E, S or A are not included.  
Example: ZM-UKF205D1;HE2305

Remarks Please refer to page A21 for size of grease fitting.

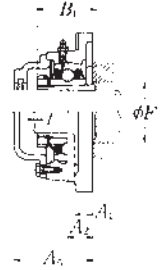
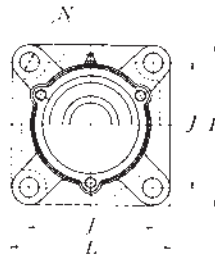
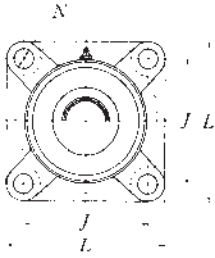

**Pressed steel dust cover type**

Open end **Z-UKF...D1**  
 Closed end **ZM-UKF...D1**

**Cast dust cover type**

Open end **C-UKF...D1**  
 Closed end **CM-UKF...D1**

Housing number	Unit number (*) pressed steel dust cover type	Unit number (*) cast dust cover type	Nominal dimensions			Mass of unit		
			mm inch			kg lb		
			t	A <sub>4</sub>	A <sub>5</sub>	UKF	Z(ZM)	C(CM)
F205D1	<b>Z(ZM)-UKF205D1;H2305X</b>	<b>C(CM)-UKF205D1;H2305X</b>	2	40	51	0.8	0.8	1.0
F205D1	<b>Z(ZM)-UKF205ED1;HE2305</b>	<b>C(CM)-UKF205ED1;HE2305</b>	$\frac{5}{64}$	$1\frac{19}{32}$	2	1.8	1.8	2.2
F206D1	<b>Z(ZM)-UKF206D1;H2306X</b>	<b>C(CM)-UKF206D1;H2306X</b>	2	45	56	1.1	1.1	1.3
F206D1	<b>Z(ZM)-UKF206SD1;HS2306</b>	<b>C(CM)-UKF206SD1;HS2306</b>	$\frac{5}{64}$	$1\frac{3}{4}$	$2\frac{7}{32}$	2.4	2.4	2.9
F206D1	<b>Z(ZM)-UKF206ED1;HE2306X</b>	<b>C(CM)-UKF206ED1;HE2306X</b>						
F207D1	<b>Z(ZM)-UKF207D1;H2307X</b>	<b>C(CM)-UKF207D1;H2307X</b>	3	49	59	1.6	1.6	1.9
F207D1	<b>Z(ZM)-UKF207SD1;HS2307</b>	<b>C(CM)-UKF207SD1;HS2307</b>	$\frac{1}{8}$	$1\frac{1}{16}$	$2\frac{5}{16}$	3.5	3.5	4.2
F208D1	<b>Z(ZM)-UKF208D1;H2308X</b>	<b>C(CM)-UKF208D1;H2308X</b>	3	56	66	1.8	1.9	2.4
F208D1	<b>Z(ZM)-UKF208ED1;HE2308X</b>	<b>C(CM)-UKF208ED1;HE2308X</b>	$\frac{1}{8}$	$2\frac{3}{16}$	$2\frac{19}{32}$	4.0	4.2	5.3
F208D1	<b>Z(ZM)-UKF208SD1;HS2308X</b>	<b>C(CM)-UKF208SD1;HS2308X</b>						
F209D1	<b>Z(ZM)-UKF209D1;H2309X</b>	<b>C(CM)-UKF209D1;H2309X</b>	3	57	70	2.3	2.3	2.8
F209D1	<b>Z(ZM)-UKF209AD1;HA2309</b>	<b>C(CM)-UKF209AD1;HA2309</b>						
F209D1	<b>Z(ZM)-UKF209ED1;HE2309X</b>	<b>C(CM)-UKF209ED1;HE2309X</b>	$\frac{1}{8}$	$2\frac{1}{4}$	$2\frac{3}{4}$	5.1	5.1	6.2
F209D1	<b>Z(ZM)-UKF209SD1;HS2309X</b>	<b>C(CM)-UKF209SD1;HS2309X</b>						
F210D1	<b>Z(ZM)-UKF210D1;H2310X</b>	<b>C(CM)-UKF210D1;H2310X</b>	3	60	72	2.6	2.7	3.2
F210D1	<b>Z(ZM)-UKF210SD1;HS2310</b>	<b>C(CM)-UKF210SD1;HS2310</b>						
F210D1	<b>Z(ZM)-UKF210AD1;HA2310</b>	<b>C(CM)-UKF210AD1;HA2310</b>	$\frac{1}{8}$	$2\frac{3}{8}$	$2\frac{27}{32}$	5.7	6.0	7.1
F210D1	<b>Z(ZM)-UKF210ED1;HE2310X</b>	<b>C(CM)-UKF210ED1;HE2310X</b>						
F211D1	<b>Z(ZM)-UKF211D1;H2311X</b>	<b>C(CM)-UKF211D1;H2311X</b>	4	64	75	3.5	3.6	4.3
F211D1	<b>Z(ZM)-UKF211SD1;HS2311</b>	<b>C(CM)-UKF211SD1;HS2311</b>						
F211D1	<b>Z(ZM)-UKF211AD1;HA2311</b>	<b>C(CM)-UKF211AD1;HA2311</b>	$\frac{5}{32}$	$2\frac{1}{2}$	$2\frac{15}{16}$	7.7	7.9	9.5
F211D1	<b>Z(ZM)-UKF211ED1;HE2311XY</b>	<b>C(CM)-UKF211ED1;HE2311XY</b>						
F212D1	<b>Z(ZM)-UKF212D1;H2312X</b>	<b>C(CM)-UKF212D1;H2312X</b>	4	74	86	4.0	4.2	5.0
F212D1	<b>Z(ZM)-UKF212SD1;HS2312</b>	<b>C(CM)-UKF212SD1;HS2312</b>	$\frac{5}{32}$	$2\frac{29}{32}$	$3\frac{3}{8}$	8.8	9.3	11

## Square flanged unit, cast housing Adapter type

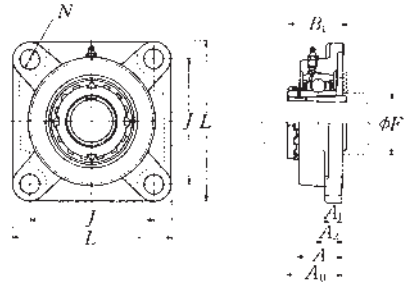

Shaft dia. mm inch	Unit number <sup>(1)</sup> ( <sup>2</sup> )	Nominal dimensions									Bolt size mm inch	Bearing number
		<i>L</i>	<i>J</i>	<i>A</i> <sub>2</sub>	<i>A</i> <sub>1</sub>	<i>A</i>	<i>N</i>	<i>A</i> <sub>0</sub>	<i>B</i> <sub>1</sub>	<i>F</i> min.		
60 2 3/16 2 1/4 2 3/8	UKF213D1;H2313X	187	149	30	22	50	19	64	65	74	M16 5/8	UK213D1;H2313X UK213D1;HA2313 UK213D1;HE2313X UK213D1;HS2313X
	UKF213D1;HA2313	7 3/8	5 5/64	1 3/16	7/8	1 31/32	3/4	2 33/64	2.559	2 29/32		
	UKF213D1;HE2313X											
	UKF213D1;HS2313X											
65 2 7/16 2 1/2	UKF215D1;H2315X	200	159	34	22	56	19	71	73	84	M16 5/8	UK215D1;H2315X UK215D1;HA2315 UK215D1;HE2315X
	UKF215D1;HA2315	7 7/8	6 17/64	1 11/32	7/8	2 7/32	3/4	2 51/64	2.874	3 3/16		
	UKF215D1;HE2315X											
70 2 11/16 2 3/4	UKF216D1;H2316X	208	165	34	22	58	23	73.5	78	90	M20 3/4	UK216D1;H2316X UK216D1;HA2316 UK216D1;HE2316X
	UKF216D1;HA2316	8 3/16	6 1/2	1 11/32	7/8	2 9/32	29/32	2 57/64	3.071	3 17/32		
	UKF216D1;HE2316X											
75 2 5/8 3	UKF217D1;H2317X	220	175	36	24	63	23	77	82	95	M20 3/4	UK217D1;H2317X UK217D1;HA2317X UK217D1;HE2317X
	UKF217D1;HA2317X	8 21/32	6 57/64	1 27/64	1 5/16	2 15/32	29/32	3 1/32	3.228	3 3/4		
	UKF217D1;HE2317X											
80 3 3/16	UKF218D1;H2318X	235	187	40	24	68	23	81.5	86	102	M20 3/4	UK218D1;H2318X UK218D1;HA2318X
	UKF218D1;HA2318X	9 1/4	7 23/64	1 37/64	1 5/16	2 11/16	29/32	3 13/64	3.386	4 1/32		

Notes <sup>(1)</sup> These numbers indicate relubricatable type. If maintenance free type is needed, please order without suffix "D1".

<sup>(2)</sup> Adapter number with suffix "X" means a narrow slot type adapter sleeve.  
In this case the lock washer with the straight inner prong should be used.

<sup>(3)</sup> If the inch series housing units with dust cover are ordered with a closed end, the suffixes E, S or A are not included.  
Example: ZM-UKF205D1;HE2305

Remarks Please refer to page A21 for size of grease fitting.

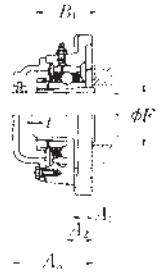
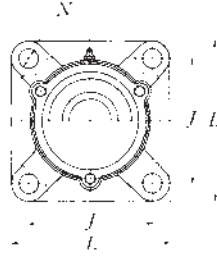
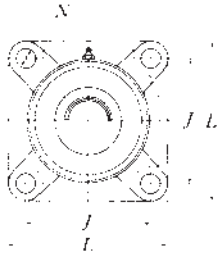

**Pressed steel dust cover type**

Open end **Z-UKF...D1**  
 Closed end **ZM-UKF...D1**

**Cast dust cover type**

Open end **C-UKF...D1**  
 Closed end **CM-UKF...D1**

Housing number	Unit number <sup>(2)</sup> pressed steel dust cover type	Unit number <sup>(2)</sup> cast dust cover type	Nominal dimensions			Mass of unit		
			mm inch			kg lb		
			t	A <sub>4</sub>	A <sub>5</sub>	UKF	Z(ZM)	C(CM)
F213D1	<b>Z(ZM)-UKF213D1;H2313X</b>	<b>C(CM)-UKF213D1;H2313X</b>	4	76	90	5.6	5.8	6.7
F213D1	<b>Z(ZM)-UKF213AD1;HA2313</b>	<b>C(CM)-UKF213AD1;HA2313</b>						
F213D1	<b>Z(ZM)-UKF213ED1;HE2313X</b>	<b>C(CM)-UKF213ED1;HE2313X</b>	5/32	3	3 7/32	12	13	15
F213D1	<b>Z(ZM)-UKF213SD1;HS2313X</b>	<b>C(CM)-UKF213SD1;HS2313X</b>						
F215D1	—	<b>C(CM)-UKF215D1;H2315X</b>	4	—	102	6.8	—	8.3
F215D1	—	<b>C(CM)-UKF215AD1;HA2315</b>						
F215D1	—	<b>C(CM)-UKF215ED1;HE2315X</b>	5/32	—	4 1/32	15	—	18
F216D1	—	<b>C(CM)-UKF216D1;H2316X</b>	4	—	106	8.3	—	10
F216D1	—	<b>C(CM)-UKF216AD1;HA2316</b>						
F216D1	—	<b>C(CM)-UKF216ED1;HE2316X</b>	5/32	—	4 3/16	18	—	22
F217D1	—	<b>C(CM)-UKF217D1;H2317X</b>	5	—	114	10	—	13
F217D1	—	<b>C(CM)-UKF217AD1;HA2317X</b>						
F217D1	—	<b>C(CM)-UKF217ED1;HE2317X</b>	13/64	—	4 1/2	22	—	29
F218D1	—	<b>C(CM)-UKF218D1;H2318X</b>	5	—	122	12	—	14
F218D1	—	<b>C(CM)-UKF218AD1;HA2318X</b>	13/64	—	4 13/16	26	—	31

## Square flanged unit, cast housing Adapter type

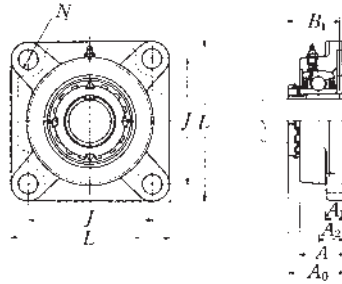

Shaft dia.  mm inch	Unit number <sup>(1)</sup> ( <sup>2</sup> )( <sup>3</sup> )	Nominal dimensions								Bolt size  mm inch
		mm inch								
		L	J	A <sub>2</sub>	A <sub>1</sub>	A	N	A <sub>0</sub>	B <sub>1</sub>	
20  3/4	UKF305D1;H2305X	110	80	16	13	29	16	37	35	M14
	UKF305D1;HE2305	4 11/32	3 5/32	5/8	1/2	1 5/32	5/8	1 29/64	1.378	1/2
25  7/8 1	UKF306D1;H2306X	125	95	18	15	32	16	40.5	38	M14
	UKF306D1;HS2306 UKF306D1;HE2306X	4 29/32	3 47/64	45/64	1 9/32	1 1/4	5/8	1 19/32	1.496	1/2
30  1 1/8	UKF307D1;H2307X	135	100	20	16	36	19	45.5	43	M16
	UKF307D1;HS2307	5 5/16	3 15/16	25/32	5/8	1 13/32	3/4	1 51/64	1.693	5/8
35  1 1/4 1 3/8	UKF308D1;H2308X	150	112	23	17	40	19	50	46	M16
	UKF308D1;HE2308X UKF308D1;HS2308X	5 29/32	4 13/32	29/32	2 1/32	1 9/16	3/4	1 31/32	1.811	5/8
40  1 7/16 1 1/2 1 5/8	UKF309D1;H2309X	160	125	25	18	44	19	54.5	50	M16
	UKF309D1;HA2309 UKF309D1;HE2309X UKF309D1;HS2309X	6 5/16	4 59/64	63/64	23/32	1 23/32	3/4	2 9/64	1.969	5/8
45  1 5/8 1 11/16 1 3/4	UKF310D1;H2310X	175	132	28	19	48	23	60.5	55	M20
	UKF310D1;HS2310 UKF310D1;HA2310 UKF310D1;HE2310X	6 7/8	5 13/64	1 7/64	3/4	1 7/8	29/32	2 3/8	2.165	3/4
50  1 7/8 1 15/16 2	UKF311D1;H2311X	185	140	30	20	52	23	64	59	M20
	UKF311D1;HS2311 UKF311D1;HA2311 UKF311D1;HE2311XY	7 9/32	5 33/64	1 3/16	25/32	2 1/16	29/32	2 23/64	2.323	3/4
55  2 1/8	UKF312D1;H2312X	195	150	33	22	56	23	69.5	62	M20
	UKF312D1;HS2312	7 11/16	5 29/32	1 19/64	7/8	2 7/32	29/32	2 47/64	2.441	3/4

Notes (1) These numbers indicate relubricatable type. If maintenance free type is needed, please order without suffix "D1".

(2) Adapter number with suffix "X" means a narrow slot type adapter sleeve.

In this case the lock washer with the straight inner prong should be used.

(3) For HE2311XY, screw thread pitch different from the standard is applied, because of the thin thread section of sleeve.

To distinguish it, a suffix "Y" is added.

(4) If the inch series housing units with dust cover are ordered with a closed end, the suffixes E, S or A are not included.

Example: CM-UKF305D1;HE2305

Remarks Please refer to page A21 for size of grease fitting.

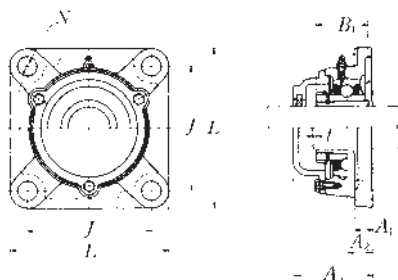

**Cast dust cover type**

Open end **C-UKF...D1**  
 Closed end **CM-UKF...D1**

Bearing number	Housing number	Unit number (*) cast dust cover type	Nominal dimensions		Mass of unit	
			mm	inch	kg	lb
			<i>t</i> max.	<i>A</i> <sub>5</sub>	UKF	C(CM)
UK305D1;H2305X	F305D1	<b>C(CM)-UKF305D1;H2305X</b>	2	56	1.1	1.5
UK305D1;HE2305	F305D1	<b>C(CM)-UKF305ED1;HE2305</b>	$\frac{5}{64}$	$2\frac{7}{32}$	2.4	3.3
UK306D1;H2306X	F306D1	<b>C(CM)-UKF306D1;H2306X</b>	2	60	1.7	2.1
UK306D1;HS2306	F306D1	<b>C(CM)-UKF306SD1;HS2306</b>	$\frac{5}{64}$	$2\frac{3}{8}$	3.7	4.6
UK306D1;HE2306X	F306D1	<b>C(CM)-UKF306ED1;HE2306X</b>				
UK307D1;H2307X	F307D1	<b>C(CM)-UKF307D1;H2307X</b>	3	68	2.1	2.7
UK307D1;HS2307	F307D1	<b>C(CM)-UKF307SD1;HS2307</b>	$\frac{1}{8}$	$2\frac{11}{16}$	4.6	6.0
UK308D1;H2308X	F308D1	<b>C(CM)-UKF308D1;H2308X</b>	3	76	2.8	3.5
UK308D1;HE2308X	F308D1	<b>C(CM)-UKF308ED1;HE2308X</b>	$\frac{1}{8}$	3	6.2	7.7
UK308D1;HS2308X	F308D1	<b>C(CM)-UKF308SD1;HS2308X</b>				
UK309D1;H2309X	F309D1	<b>C(CM)-UKF309D1;H2309X</b>	3	80	3.4	4.4
UK309D1;HA2309	F309D1	<b>C(CM)-UKF309AD1;HA2309</b>				
UK309D1;HE2309X	F309D1	<b>C(CM)-UKF309ED1;HE2309X</b>	$\frac{1}{8}$	$3\frac{5}{32}$	7.5	9.7
UK309D1;HS2309X	F309D1	<b>C(CM)-UKF309SD1;HS2309X</b>				
UK310D1;H2310X	F310D1	<b>C(CM)-UKF310D1;H2310X</b>	3	88	4.5	5.9
UK310D1;HS2310	F310D1	<b>C(CM)-UKF310SD1;HS2310</b>				
UK310D1;HA2310	F310D1	<b>C(CM)-UKF310AD1;HA2310</b>	$\frac{1}{8}$	$3\frac{15}{32}$	9.9	13
UK310D1;HE2310X	F310D1	<b>C(CM)-UKF310ED1;HE2310X</b>				
UK311D1;H2311X	F311D1	<b>C(CM)-UKF311D1;H2311X</b>	4	92	5.3	6.8
UK311D1;HS2311	F311D1	<b>C(CM)-UKF311SD1;HS2311</b>				
UK311D1;HA2311	F311D1	<b>C(CM)-UKF311AD1;HA2311</b>	$\frac{5}{32}$	$3\frac{5}{8}$	12	15
UK311D1;HE2311XY	F311D1	<b>C(CM)-UKF311ED1;HE2311XY</b>				
UK312D1;H2312X	F312D1	<b>C(CM)-UKF312D1;H2312X</b>	4	100	6.3	7.9
UK312D1;HS2312	F312D1	<b>C(CM)-UKF312SD1;HS2312</b>	$\frac{5}{32}$	$3\frac{15}{16}$	14	17



## Squire flanged unit, cast housing Adapter type

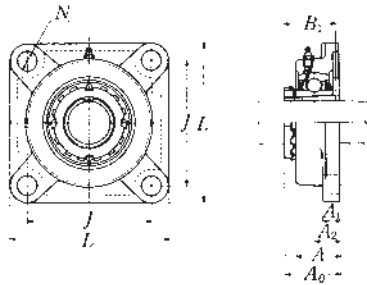

Shaft dia.  mm inch	Unit number <sup>(1)(c)</sup>	Nominal dimensions								Bolt size  mm inch
		mm inch								
		L	J	A <sub>2</sub>	A <sub>1</sub>	A	N	A <sub>0</sub>	B <sub>1</sub>	
60 2 3/16 2 1/4 2 3/8	UKF313D1;H2313X UKF313D1;HA2313 UKF313D1;HE2313X UKF313D1;HS2313X	208	166	33	22	58	23	71.5	65	M20  3/4
65 2 7/16 2 1/2	UKF315D1;H2315X UKF315D1;HA2315 UKF315D1;HE2315X	236	184	39	25	66	25	81.5	73	M22  7/8
70 2 11/16 2 3/4	UKF316D1;H2316X UKF316D1;HA2316 UKF316D1;HE2316X	250	196	38	27	68	31	84	78	M27  1
75 2 15/16 3	UKF317D1;H2317X UKF317D1;HA2317X UKF317D1;HE2317X	260	204	44	27	74	31	92	82	M27  1
80 3 13/16	UKF318D1;H2318X UKF318D1;HA2318X	280	216	44	30	76	35	94	86	M30  1 1/8
85 3 3/4	UKF319D1;H2319X UKF319D1;HE2319X	290	228	59	30	94	35	111.5	90	M30  1 1/8
90 3 7/16 3 1/2	UKF320D1;H2320X UKF320D1;HA2320 UKF320D1;HE2320X	310	242	59	32	94	38	115.5	97	M33  1 1/4
100	UKF322D1;H2322X	340	266	60	35	96	41	121	105	M36
110	UKF324D1;H2324	370	290	65	40	110	41	130	112	M36
115	UKF326D1;H2326	410	320	65	45	115	41	133	121	M36
125	UKF328D1;H2328	450	350	75	55	125	41	146.5	131	M36

Notes <sup>(1)</sup> These numbers indicate relubricatable type. If maintenance free type is needed, please order without suffix "D1".

<sup>(2)</sup> Adapter number with suffix "X" means a narrow slot type adapter sleeve. In this case the lock washer with the straight inner prong should be used.

<sup>(3)</sup> If the inch series housing units with dust cover are ordered with a closed end, the suffixes E, S or A are not included. Example: CM-UKF305D1;HE2305

Remarks Please refer to page A21 for size of grease fitting.



## Square flanged unit, cast housing Adapter type

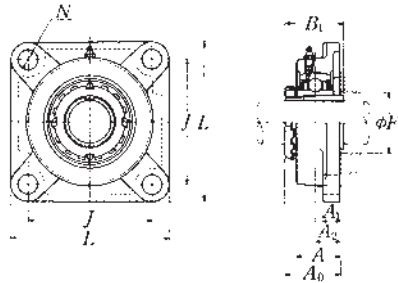

Shaft dia. mm inch	Unit number <sup>(1)</sup> / <sub>(2)</sub> / <sub>(3)</sub>	Nominal dimensions									Bolt size mm inch
		L	J	A <sub>2</sub>	A <sub>1</sub>	mm inch		A	N	A <sub>0</sub>	
20 3/4	UKFX05D1;H2305X UKFX05D1;HE2305	108 4 1/4	83 3 17/64	18 45/64	13 1/2	30 1 3/16	12 15/32	39 1 17/32	35 1.378	-	M10 3/8
25 7/8 1	UKFX06D1;H2306X UKFX06D1;HS2306 UKFX06D1;HE2306X	117 4 19/32	92 3 5/8	19 3/4	14 9/16	34 1 11/32	16 5/8	41.5 1 41/64	38 1.496	-	M14 1/2
30 1 1/8	UKFX07D1;H2307X UKFX07D1;HS2307	130 5 1/8	102 4 1/64	21 53/64	14 9/16	38 1 1/2	16 5/8	45.5 1 51/64	43 1.693	-	M14 1/2
35 1 1/4 1 3/8	UKFX08D1;H2308X UKFX08D1;HE2308X UKFX08D1;HS2308X	137 5 13/32	105 4 9/64	22 55/64	14 9/16	40 1 9/16	19 3/4	47.5 1 7/8	46 1.811	46 1 13/16	M16 5/8
40 1 7/16 1 1/2 1 5/8	UKFX09D1;H2309X UKFX09D1;HA2309 UKFX09D1;HE2309X UKFX09D1;HS2309X	143 5 5/8	111 4 3/8	23 29/32	14 9/16	40 1 9/16	19 3/4	50 1 31/32	50 1.969	52 2 1/16	M16 5/8
45 1 5/8 1 11/16 1 3/4	UKFX10D1;H2310X UKFX10D1;HS2310 UKFX10D1;HA2310 UKFX10D1;HE2310X	162 6 3/8	130 5 1/8	26 1 1/32	20 25/32	44 1 23/32	19 3/4	55.5 2 3/16	55 2.165	57 2 1/4	M16 5/8
50 1 7/8 1 15/16 2	UKFX11D1;H2311X UKFX11D1;HS2311 UKFX11D1;HA2311 UKFX11D1;HE2311XY	175 6 7/8	143 5 5/8	29 1 9/64	20 25/32	49 1 15/16	19 3/4	60 2 23/64	59 2.323	64 2 17/32	M16 5/8
55 2 1/8	UKFX12D1;H2312X UKFX12D1;HS2312	187 7 3/8	149 5 55/64	34 1 11/32	21 13/16	59 2 5/16	19 3/4	67 2 21/64	62 2.441	-	M16 5/8

Notes <sup>(1)</sup> These numbers indicate relubricatable type. If maintenance free type is needed, please order without suffix "D1".

<sup>(2)</sup> Adapter number with suffix "X" means a narrow slot type adapter sleeve.  
In this case the lock washer with the straight inner prong should be used.

<sup>(3)</sup> For HE2311XY, screw thread pitch different from the standard is applied, because of the thin thread section of sleeve.  
To distinguish it, a suffix "Y" is added.

<sup>(4)</sup> If the inch series housing units with dust cover are ordered with a closed end, the suffixes E, S or A are not included.  
Example: CM-UKFX05D1;HE2305

Remarks Please refer to page A21 for size of grease fitting.

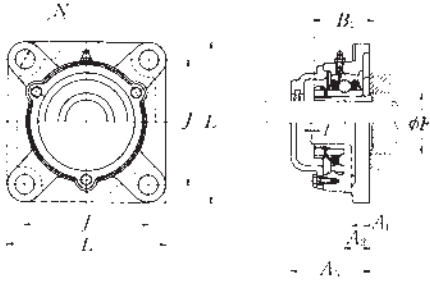

**Cast dust cover type**

Open end **C-UKF...D1**

Closed end **CM-UKF...D1**

Bearing number	Housing number	Unit number (*) cast dust cover type	Nominal dimensions		Mass of unit	
			mm inch		kg lb	
			t max.	A <sub>5</sub>	UKF	C(CM)
UKX05D1;H2305X UKX05D1;HE2305	FX05D1 FX05D1	<b>C(CM)-UKFX05D1;H2305X</b> <b>C(CM)-UKFX05ED1;HE2305</b>	2 5/64	56 2 7/32	1.1 2.4	1.3 2.9
UKX06D1;H2306X UKX06D1;HS2306 UKX06D1;HE2306X	FX06D1 FX06D1 FX06D1	<b>C(CM)-UKFX06D1;H2306X</b> <b>C(CM)-UKFX06SD1;HS2306</b> <b>C(CM)-UKFX06ED1;HE2306X</b>	2 5/64	59 2 9/16	1.6 3.5	1.8 4.0
UKX07D1;H2307X UKX07D1;HS2307	FX07D1 FX07D1	<b>C(CM)-UKFX07D1;H2307X</b> <b>C(CM)-UKFX07SD1;HS2307</b>	3 1/8	66 2 9/32	2.1 4.6	2.5 5.5
UKX08D1;H2308X UKX08D1;HE2308X UKX08D1;HS2308X	FX08D1 FX08D1 FX08D1	<b>C(CM)-UKFX08D1;H2308X</b> <b>C(CM)-UKFX08ED1;HE2308X</b> <b>C(CM)-UKFX08SD1;HS2308X</b>	3 1/8	70 2 3/4	2.5 5.5	2.9 6.4
UKX09D1;H2309X UKX09D1;HA2309 UKX09D1;HE2309X UKX09D1;HS2309X	FX09D1 FX09D1 FX09D1 FX09D1	<b>C(CM)-UKFX09D1;H2309X</b> <b>C(CM)-UKFX09AD1;HA2309</b> <b>C(CM)-UKFX09ED1;HE2309X</b> <b>C(CM)-UKFX09SD1;HS2309X</b>	3 1/8	73 2 7/8	2.5 5.5	3.0 6.6
UKX10D1;H2310X UKX10D1;HS2310 UKX10D1;HA2310 UKX10D1;HE2310X	FX10D1 FX10D1 FX10D1 FX10D1	<b>C(CM)-UKFX10D1;H2310X</b> <b>C(CM)-UKFX10SD1;HS2310</b> <b>C(CM)-UKFX10AD1;HA2310</b> <b>C(CM)-UKFX10ED1;HE2310X</b>	3 1/8	76 3	3.8 8.4	4.4 9.7
UKX11D1;H2311X UKX11D1;HS2311 UKX11D1;HA2311 UKX11D1;HE2311XY	FX11D1 FX11D1 FX11D1 FX11D1	<b>C(CM)-UKFX11D1;H2311X</b> <b>C(CM)-UKFX11SD1;HS2311</b> <b>C(CM)-UKFX11AD1;HA2311</b> <b>C(CM)-UKFX11ED1;HE2311XY</b>	4 5/32	86 3 3/8	4.7 10	5.4 12
UKX12D1;H2312X UKX12D1;HS2312	FX12D1 FX12D1	<b>C(CM)-UKFX12D1;H2312X</b> <b>C(CM)-UKFX12SD1;HS2312</b>	4 5/32	94 3 31/32	6.4 14	7.2 16

## Square flanged unit, cast housing Adapter type

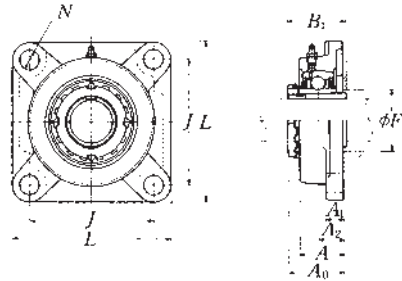

Shaft dia. mm inch	Unit number <sup>(1)</sup> ( <sup>2</sup> )	Nominal dimensions									Bolt size mm inch
		L	J	A <sub>2</sub>	A <sub>1</sub>	A	N	A <sub>0</sub>	B <sub>1</sub>	F min.	
60 2 3/16 2 1/4 2 3/8	UKFX13D1;H2313X UKFX13D1;HA2313 UKFX13D1;HE2313X UKFX13D1;HS2313X	187	149	34	21	59	19	69	65	-	M16
		7 3/8	5 55/64	1 11/32	1 5/16	2 5/16	3/4	2 29/32	2.559	-	5/8
65 2 7/16 2 1/2	UKFX15D1;H2315X UKFX15D1;HA2315 UKFX15D1;HE2315X	197	152	40	24	68	23	77.5	73	-	M20
		7 3/4	5 83/64	1 37/64	1 5/16	2 11/16	29/32	3 3/64	2.874	-	3/4
70 2 11/16 2 3/4	UKFX16D1;H2316X UKFX16D1;HA2316 UKFX16D1;HE2316X	214	171	40	24	70	23	80	78	90	M20
		8 7/16	6 47/64	1 37/64	1 5/16	2 3/4	29/32	3 5/32	3.071	3 17/32	3/4
75 2 15/16 3	UKFX17D1;H2317X UKFX17D1;HA2317X UKFX17D1;HE2317X	214	171	40	24	70	23	81.5	82	95	M20
		8 7/16	6 47/64	1 37/64	1 5/16	2 3/4	29/32	3 13/64	3.228	3 3/4	3/4
80 3 3/16	UKFX18D1;H2318X UKFX18D1;HA2318X	214	171	45	24	76	23	87.5	86	102	M20
		8 7/16	6 47/64	1 49/64	1 5/16	3	29/32	3 7/16	3.386	4 1/32	3/4
90	UKFX20D1;H2320X	268	211	59	31	97	31	107.5	97	-	M27

Notes <sup>(1)</sup> These numbers indicate relubricatable type. If maintenance free type is needed, please order without suffix "D1".

<sup>(2)</sup> Adapter number with suffix "X" means a narrow slot type adapter sleeve. In this case the lock washer with the straight inner prong should be used.

<sup>(3)</sup> If the inch series housing units with dust cover are ordered with a closed end, the suffixes E, S or A are not included. Example: CM-UKFX05D1;HE2305

Remarks Please refer to page A21 for size of grease fitting.



## Square flanged unit, cast housing with spigot joint Adapter type

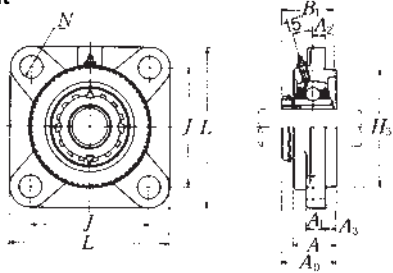

Shaft dia.  mm inch	Unit number <sup>(1)</sup> / <sub>(2)</sub> / <sub>(3)</sub>	Nominal dimensions										Bolt size  mm inch
		mm inch										
		L	J	A <sub>2</sub>	N	A <sub>3</sub>	A <sub>1</sub>	A	H <sub>3</sub>	A <sub>0</sub>	B <sub>1</sub>	
20 3/4	UKFS305D1;H2305X UKFS305D1;HE2305	110 4 11/32	80 3 5/32	9 23/64	16 5/8	7 9/32	13 1/2	29 1 9/64	80 3.1496	37 1 29/64	35 1.378	M14 1/2
25 7/8 1	UKFS306D1;H2306X UKFS306D1;HS2306 UKFS306D1;HE2306X	125 4 29/32	95 3 47/64	10 25/64	16 5/8	8 5/16	15 19/32	32 1 17/64	90 3.5433	40.5 1 19/32	38 1.496	M14 1/2
30 1 1/8	UKFS307D1;H2307X UKFS307D1;HS2307	135 5 5/16	100 3 5/16	11 7/16	19 3/4	9 23/64	16 5/8	36 1 13/32	100 3.9370	45.5 1 51/64	43 1.693	M16 5/8
35 1 1/4 1 3/8	UKFS308D1;H2308X UKFS308D1;HE2308X UKFS308D1;HS2308X	150 5 29/32	112 4 13/32	13 33/64	19 3/4	10 25/64	17 21/32	40 1 9/16	115 4.5276	50 1 31/32	46 1.811	M16 5/8
40 1 7/16 1 1/2 1 5/8	UKFS309D1;H2309X UKFS309D1;HA2309 UKFS309D1;HE2309X UKFS309D1;HS2309X	160 6 5/16	125 4 59/64	14 35/64	19 3/4	11 7/16	18 23/32	44 1 47/64	125 4.9213	54.5 2 9/64	50 1.969	M16 5/8
45 1 5/8 1 11/16 1 3/4	UKFS310D1;H2310X UKFS310D1;HS2310 UKFS310D1;HA2310 UKFS310D1;HE2310X	175 6 7/8	132 5 13/64	16 5/8	23 29/32	12 15/32	19 3/4	48 1 57/64	140 5.5118	60.5 2 3/8	55 2.165	M20 3/4
50 1 7/8 1 9/16 2	UKFS311D1;H2311X UKFS311D1;HS2311 UKFS311D1;HA2311 UKFS311D1;HE2311XY	185 7 9/32	140 5 33/64	17 43/64	23 29/32	13 33/64	20 25/32	52 2 3/64	150 5.9055	64 2 33/64	59 2.323	M20 3/4
55 2 1/8	UKFS312D1;H2312X UKFS312D1;HS2312	195 7 11/16	150 5 29/32	19 3/4	23 29/32	14 35/64	22 7/8	56 2 13/64	160 6.2992	69.5 2 47/64	62 2.441	M20 3/4

Notes <sup>(1)</sup> These numbers indicate relubricatable type. If maintenance free type is needed, please order without suffix "D1".

<sup>(2)</sup> Adapter number with suffix "X" means a narrow slot type adapter sleeve. In this case the lock washer with the straight inner prong should be used.

<sup>(3)</sup> For HE2311XY, screw thread pitch different from the standard is applied, because of the thin thread section of sleeve. To distinguish it, a suffix "Y" is added.

<sup>(4)</sup> If the inch series housing units with dust cover are ordered with a closed end, the suffixes E, S or A are not included. Example: CM-UKFS305D1;HE2305

Remarks Please refer to page A21 for size of grease fitting.

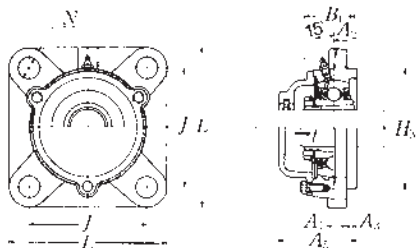

**Cast dust cover type**

Open end **C-UKFS...D1**

Closed end **CM-UKFS...D1**

Bearing number	Housing number	Unit number (*) cast dust cover type	Nominal dimensions		Mass of unit	
			mm	inch	kg lb	
			<i>t</i> max.	<i>A</i> <sub>5</sub>	UKFS	C(CM)
UK305D1;H2305X UK305D1;HE2305	FS305D1 FS305D1	C(CM)-UKFS305D1;H2305X C(CM)-UKFS305ED1;HE2305	2 5/64	56 2 <sup>13</sup> /64	1.2 2.6	1.5 3.3
UK306D1;H2306X UK306D1;HS2306 UK306D1;HE2306X	FS306D1 FS306D1 FS306D1	C(CM)-UKFS306D1;H2306X C(CM)-UKFS306SD1;HS2306 C(CM)-UKFS306ED1;HE2306X	2 5/64	60 2 <sup>23</sup> /64	1.8 4.0	2.2 4.9
UK307D1;H2307X UK307D1;HS2307	FS307D1 FS307D1	C(CM)-UKFS307D1;H2307X C(CM)-UKFS307SD1;HS2307	3 1/8	67 2 <sup>11</sup> /64	2.3 5.1	2.9 6.4
UK308D1;H2308X UK308D1;HE2308X UK308D1;HS2308X	FS308D1 FS308D1 FS308D1	C(CM)-UKFS308D1;H2308X C(CM)-UKFS308ED1;HE2308X C(CM)-UKFS308SD1;HS2308X	3 1/8	76 2 <sup>63</sup> /64	3.2 7.1	3.7 8.2
UK309D1;H2309X UK309D1;HA2309 UK309D1;HE2309X UK309D1;HS2309X	FS309D1 FS309D1 FS309D1 FS309D1	C(CM)-UKFS309D1;H2309X C(CM)-UKFS309AD1;HA2309 C(CM)-UKFS309ED1;HE2309X C(CM)-UKFS309SD1;HS2309X	3 1/8	80 3 <sup>5</sup> /32	3.8 8.4	4.7 10
UK310D1;H2310X UK310D1;HS2310 UK310D1;HA2310 UK310D1;HE2310X	FS310D1 FS310D1 FS310D1 FS310D1	C(CM)-UKFS310D1;H2310X C(CM)-UKFS310SD1;HS2310 C(CM)-UKFS310AD1;HA2310 C(CM)-UKFS310ED1;HE2310X	3 1/8	88 3 <sup>15</sup> /32	5.1 11	6.3 14
UK311D1;H2311X UK311D1;HS2311 UK311D1;HA2311 UK311D1;HE2311XY	FS311D1 FS311D1 FS311D1 FS311D1	C(CM)-UKFS311D1;H2311X C(CM)-UKFS311SD1;HS2311 C(CM)-UKFS311AD1;HA2311 C(CM)-UKFS311ED1;HE2311XY	4 5/32	93 3 <sup>21</sup> /32	5.9 13	7.3 16
UK312D1;H2312X UK312D1;HS2312	FS312D1 FS312D1	C(CM)-UKFS312D1;H2312X C(CM)-UKFS312SD1;HS2312	4 5/32	100 3 <sup>15</sup> /16	7.0 15	8.4 19



## Square flanged unit, cast housing with spigot Adapter type

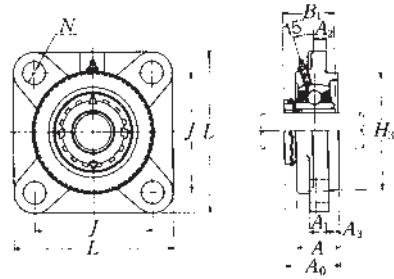

Shaft dia.	Unit number <sup>(1)</sup> ( <sup>2</sup> )	Nominal dimensions										Bolt size
		mm inch										
mm inch		L	J	A <sub>2</sub>	N	A <sub>3</sub>	A <sub>1</sub>	A	H <sub>3</sub>	A <sub>0</sub>	B <sub>1</sub>	mm inch
60	UKFS313D1;H2313X UKFS313D1;HA2313 UKFS313D1;HE2313X UKFS313D1;HS2313X	208	166	15	33	18	22	58	175	71.5	65	M20
2 3/16 2 1/4 2 3/8		8 3/16	6 17/32	19/32	29/32	45/64	7/8	2 9/32	6.8898	2 19/16	2.559	3/4
65	UKFS315D1;H2315X UKFS315D1;HA2315 UKFS315D1;HE2315X	236	184	21	25	18	25	66	200	81.5	73	M22
2 7/16 2 1/2		9 9/32	7 1/4	53/64	63/64	45/64	31/32	2 19/32	7.8740	3 13/64	2.874	7/8
70	UKFS316D1;H2316X UKFS316D1;HA2316 UKFS316D1;HE2316X	250	196	18	31	20	27	68	210	84	78	M27
2 11/16 2 3/4		9 27/32	7 23/32	45/64	1 1/32	25/32	1 1/16	2 43/64	8.2677	3 5/16	3.071	1
75	UKFS317D1;H2317X UKFS317D1;HA2317X UKFS317D1;HE2317X	260	204	24	31	20	27	74	220	92	82	M27
2 5/16 3		10 1/4	8 1/32	15/16	1 1/32	25/32	1 1/16	2 29/32	8.6614	3 5/8	3.228	1
80	UKFS318D1;H2318X UKFS318D1;HA2318X	280	216	24	35	20	30	76	240	94	86	M30
3 3/16		11 1/32	8 1/2	15/16	1 3/8	25/32	1 3/16	2 63/64	9.4488	3 45/64	3.386	1 1/8
85	UKFS319D1;H2319X UKFS319D1;HE2319X	290	228	39	35	20	30	94	250	111.5	90	M30
3 3/4		11 13/32	8 31/32	1 17/32	1 3/8	25/32	1 3/16	3 45/64	9.8425	4 25/64	3.543	1 1/8
90	UKFS320D1;H2320X UKFS320D1;HA2320 UKFS320D1;HE2320X	310	242	39	38	20	32	94	260	115.5	97	M33
3 7/16 3 1/2		12 7/32	9 17/32	1 17/32	1 1/2	25/32	1 1/4	3 45/64	10.2362	4 35/64	3.819	1 1/4
100	UKFS322D1;H2322X	340	266	35	41	25	35	96	300	121	105	M36
110	UKFS324D1;H2324	370	290	35	41	30	40	110	330	130	112	M36
115	UKFS326D1;H2326	410	320	35	41	30	45	115	360	133	121	M36
125	UKFS328D1;H2328	450	350	45	41	30	55	125	400	146.5	131	M36

Notes <sup>(1)</sup> These numbers indicate relubricatable type. If maintenance free type is needed, please order without suffix "D1".

<sup>(2)</sup> Adapter number with suffix "X" means a narrow slot type adapter sleeve. In this case the lock washer with the straight inner prong should be used.

<sup>(3)</sup> If the inch series housing units with dust cover are ordered with a closed end, the suffixes E, S or A are not included. Example: CM-UKFS305D1;HE2305

Remarks Please refer to page A21 for size of grease fitting.

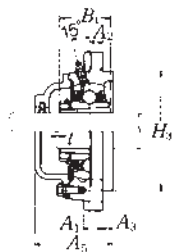
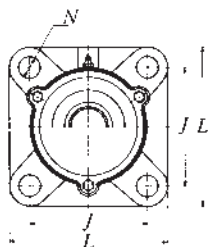

**Cast dust cover type**

Open end **C-UKFS...D1**

Closed end **CM-UKFS...D1**

Bearing number	Housing number	Unit number <sup>(*)</sup> cast dust cover type	Nominal dimensions		Mass of unit	
			mm	inch	kg lb	
			t	A <sub>5</sub>	UKFS	C(CM)
			max.			
UK313D1;H2313X	FS313D1	<b>C(CM)-UKFS313D1;H2313X</b>	4	103	8.4	10
UK313D1;HA2313	FS313D1	<b>C(CM)-UKFS313AD1;HA2313</b>				
UK313D1;HE2313X	FS313D1	<b>C(CM)-UKFS313ED1;HE2313X</b>	5/32	4 1/16	19	22
UK313D1;HS2313X	FS313D1	<b>C(CM)-UKFS313SD1;HS2313X</b>				
UK315D1;H2315X	FS315D1	<b>C(CM)-UKFS315D1;H2315X</b>	4	114	12	14
UK315D1;HA2315	FS315D1	<b>C(CM)-UKFS315AD1;HA2315</b>				
UK315D1;HE2315X	FS315D1	<b>C(CM)-UKFS315ED1;HE2315X</b>	5/32	4 3/64	26	31
UK316D1;H2316X	FS316D1	<b>C(CM)-UKFS316D1;H2316X</b>	4	116	15	17
UK316D1;HA2316	FS316D1	<b>C(CM)-UKFS316AD1;HA2316</b>				
UK316D1;HE2316X	FS316D1	<b>C(CM)-UKFS316ED1;HE2316X</b>	5/32	4 9/16	33	37
UK317D1;H2317X	FS317D1	<b>C(CM)-UKFS317D1;H2317X</b>	5	129	17	20
UK317D1;HA2317X	FS317D1	<b>C(CM)-UKFS317AD1;HA2317X</b>				
UK317D1;HE2317X	FS317D1	<b>C(CM)-UKFS317ED1;HE2317X</b>	13/64	5 5/64	37	44
UK318D1;H2318X	FS318D1	<b>C(CM)-UKFS318D1;H2318X</b>	5	129	21	24
UK318D1;HA2318X	FS318D1	<b>C(CM)-UKFS318AD1;HA2318X</b>	13/64	5 5/64	46	53
UK319D1;H2319X	FS319D1	<b>C(CM)-UKFS319D1;H2319X</b>	5	149	24	29
UK319D1;HE2319X	FS319D1	<b>C(CM)-UKFS319ED1;HE2319X</b>	13/64	5 55/64	53	64
UK320D1;H2320X	FS320D1	<b>C(CM)-UKFS320D1;H2320X</b>	5	154	29	34
UK320D1;HA2320	FS320D1	<b>C(CM)-UKFS320AD1;HA2320</b>				
UK320D1;HE2320X	FS320D1	<b>C(CM)-UKFS320ED1;HE2320X</b>	13/64	6 1/16	64	75
UK322D1;H2322X	FS322D1	<b>C(CM)-UKFS322D1;H2322X</b>	5	160	38	46
UK324D1;H2324	FS324D1	<b>C(CM)-UKFS324D1;H2324</b>	5	172	51	59
UK326D1;H2326	FS326D1	<b>C(CM)-UKFS326D1;H2326</b>	6	178	69	79
UK328D1;H2328	FS328D1	<b>C(CM)-UKFS328D1;H2328</b>	6	192	98	110

## Round flanged unit, cast housing with spigot joint Adapter type

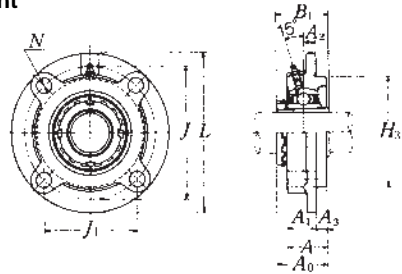

Shaft dia. mm inch	Unit number <sup>(1)</sup> ( <sup>2</sup> )( <sup>3</sup> )	Nominal dimensions													Bolt size mm inch	Bearing number
		L	J	(J <sub>1</sub> )	A <sub>2</sub>	N	A <sub>3</sub>	A <sub>1</sub>	A	H <sub>3</sub>	A <sub>0</sub>	B <sub>1</sub>	F min.			
20 3/4	UKFC205D1;H2305X UKFC205D1;HE2305	115 4 17/32	90 3 5/64	63.6 2 1/2	10 25/64	12 15/32	6 15/64	21 13/16	27 1 1/16	70 2.7559	35.5 1 25/64	35 1.378	30 1 3/16	M10 3/8	UK205D1;H2305X UK205D1;HE2305	
25 7/8 1	UKFC206D1;H2306X UKFC206D1;HS2306 UKFC206D1;HE2306X	125 4 29/32	100 3 15/16	70.7 2 25/32	10 25/64	12 15/32	8 5/16	23 29/32	31 1 7/32	80 3.1496	39 1 17/32	38 1.496	36 1 13/32	M10 3/8	UK206D1;H2306X UK206D1;HS2306 UK206D1;HE2306X	
30 1 1/8	UKFC207D1;H2307X UKFC207D1;HS2307	135 5 5/16	110 4 21/64	77.8 3 1/16	11 7/16	14 35/64	8 5/16	26 1 1/32	34 1 11/32	90 3.5433	42.5 1 43/64	43 1.693	40 1 9/16	M12 7/16	UK207D1;H2307X UK207D1;HS2307	
35 1 1/4 1 3/8	UKFC208D1;H2308X UKFC208D1;HE2308X UKFC208D1;HS2308X	145 5 23/32	120 4 23/32	84.9 3 11/32	11 7/16	14 35/64	10 25/64	26 1 1/32	36 1 27/64	100 3.9370	46.5 1 53/64	46 1.811	46 1 13/16	M12 7/16	UK208D1;H2308X UK208D1;HE2308X UK208D1;HS2308X	
40 1 7/16 1 1/2 1 5/8	UKFC209D1;H2309X UKFC209D1;HA2309 UKFC209D1;HE2309X UKFC209D1;HS2309X	160 6 5/16	132 5 13/64	93.3 3 43/64	10 25/64	16 5/8	12 15/32	26 1 1/32	38 1 1/2	105 4.1339	48.5 1 29/32	50 1.969	52 2 1/16	M14 1/2	UK209D1;H2309X UK209D1;HA2309 UK209D1;HE2309X UK209D1;HS2309X	
45 1 5/8 1 11/16 1 3/4	UKFC210D1;H2310X UKFC210D1;HS2310 UKFC210D1;HA2310 UKFC210D1;HE2310X	165 6 1/2	138 5 7/16	97.6 3 27/32	10 25/64	16 5/8	12 15/32	28 1 3/8	40 1 37/64	110 4.3307	50 1 31/32	55 2.165	57 2 1/4	M14 1/2	UK210D1;H2310X UK210D1;HS2310 UK210D1;HA2310 UK210D1;HE2310X	
50 1 7/8 1 15/16 2	UKFC211D1;H2311X UKFC211D1;HS2311 UKFC211D1;HA2311 UKFC211D1;HE2311XY	185 7 9/32	150 5 29/32	106.1 4 11/64	13 33/64	19 3/4	12 15/32	31 1 7/32	43 1 11/16	125 4.9213	54.5 2 9/64	59 2.323	64 2 17/32	M16 5/8	UK211D1;H2311X UK211D1;HS2311 UK211D1;HA2311 UK211D1;HE2311XY	
55 2 1/8	UKFC212D1;H2312X UKFC212D1;HS2312	195 7 11/16	160 6 19/64	113.1 4 29/64	17 43/64	19 3/4	12 15/32	36 1 13/32	48 1 57/64	135 5.3150	61 2 13/32	62 2.441	69 2 23/32	M16 5/8	UK212D1;H2312X UK212D1;HS2312	

Notes <sup>(1)</sup> These numbers indicate relubricatable type. If maintenance free type is needed, please order without suffix "D1".

<sup>(2)</sup> Adapter number with suffix "X" means a narrow slot type adapter sleeve.  
In this case the lock washer with the straight inner prong should be used.

<sup>(3)</sup> For HE2311XY, screw thread pitch different from the standard is applied, because of the thin thread section of sleeve.  
To distinguish it, a suffix "Y" is added.

<sup>(4)</sup> If the inch series housing units with dust cover are ordered with a closed end, the suffixes E, S or A are not included.  
Example: ZM-UKFC205D1;HE2305

Remarks Please refer to page A21 for size of grease fitting.

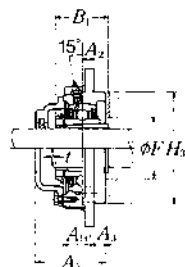
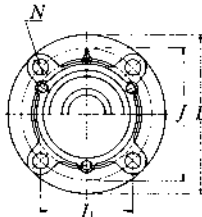
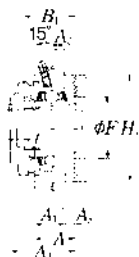
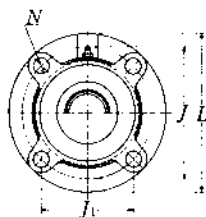

**Pressed steel dust cover type**

Open end **Z-UKFC...D1**

Closed end **ZM-UKFC...D1**

**Cast dust cover type**

Open end **C-UKFC...D1**

Closed end **CM-UKFC...D1**

Housing number	Unit number (*) pressed steel dust cover type	Unit number (*) cast dust cover type	Nominal dimensions				Mass of unit		
			mm		inch		kg lb		
			t	A <sub>4</sub>	A <sub>1c</sub>	A <sub>5</sub>	UKFC	Z(ZM)	C(CM)
FC205D1	Z(ZM)-UKFC205D1;H2305X	C(CM)-UKFC205D1;H2305X	2	40	22	51	1.0	1.1	1.2
FC205D1	Z(ZM)-UKFC205ED1;HE2305	C(CM)-UKFC205ED1;HE2305	5/64	1 19/32	7/8	2	2.2	2.4	2.6
FC206D1	Z(ZM)-UKFC206D1;H2306X	C(CM)-UKFC206D1;H2306X	2	45	24.5	56	1.3	1.4	1.7
FC206D1	Z(ZM)-UKFC206SD1;HS2306	C(CM)-UKFC206SD1;HS2306	5/64	1 3/4	3 1/32	2 19/64	2.9	3.1	3.7
FC207D1	Z(ZM)-UKFC207D1;H2307X	C(CM)-UKFC207D1;H2307X	3	49	26	59	1.7	1.8	2.0
FC207D1	Z(ZM)-UKFC207SD1;HS2307	C(CM)-UKFC207SD1;HS2307	1/8	1 15/16	1 1/2	2 21/64	3.7	4.0	4.4
FC208D1	Z(ZM)-UKFC208D1;H2308X	C(CM)-UKFC208D1;H2308X	3	56	27.5	66	2.1	2.2	2.6
FC208D1	Z(ZM)-UKFC208ED1;HE2308X	C(CM)-UKFC208ED1;HE2308X	1/8	2 3/16	1 5/64	2 19/32	4.6	4.9	5.7
FC209D1	Z(ZM)-UKFC209D1;H2309X	C(CM)-UKFC209D1;H2309X	3	57	28	70	2.8	2.9	3.4
FC209D1	Z(ZM)-UKFC209AD1;HA2309	C(CM)-UKFC209AD1;HA2309	1/8	2 1/4	1 7/64	2 3/4	6.2	6.4	7.5
FC209D1	Z(ZM)-UKFC209ED1;HE2309X	C(CM)-UKFC209ED1;HE2309X	1/8	2 1/4	1 7/64	2 3/4	6.2	6.4	7.5
FC210D1	Z(ZM)-UKFC210D1;H2310X	C(CM)-UKFC210D1;H2310X	3	60	29	72	3.1	3.3	4.8
FC210D1	Z(ZM)-UKFC210SD1;HS2310	C(CM)-UKFC210SD1;HS2310	1/8	2 3/8	3 3/8	2 59/64	6.8	7.3	11
FC210D1	Z(ZM)-UKFC210AD1;HA2310	C(CM)-UKFC210AD1;HA2310	1/8	2 3/8	3 3/8	2 59/64	6.8	7.3	11
FC210D1	Z(ZM)-UKFC210ED1;HE2310X	C(CM)-UKFC210ED1;HE2310X	1/8	2 3/8	3 3/8	2 59/64	6.8	7.3	11
FC211D1	Z(ZM)-UKFC211D1;H2311X	C(CM)-UKFC211D1;H2311X	4	64	32.5	75	4.2	4.4	5.1
FC211D1	Z(ZM)-UKFC211SD1;HS2311	C(CM)-UKFC211SD1;HS2311	5/32	2 1/2	3 3/8	2 29/64	9.3	9.7	11
FC211D1	Z(ZM)-UKFC211AD1;HA2311	C(CM)-UKFC211AD1;HA2311	5/32	2 1/2	3 3/8	2 29/64	9.3	9.7	11
FC211D1	Z(ZM)-UKFC211ED1;HE2311XY	C(CM)-UKFC211ED1;HE2311XY	5/32	2 1/2	3 3/8	2 29/64	9.3	9.7	11
FC212D1	Z(ZM)-UKFC212D1;H2312X	C(CM)-UKFC212D1;H2312X	4	74	38	86	5.0	5.2	6.1
FC212D1	Z(ZM)-UKFC212SD1;HS2312	C(CM)-UKFC212SD1;HS2312	5/32	2 29/32	3 3/8	3 25/64	11	11	13

## Round flanged unit, cast housing with spigot joint Adapter type

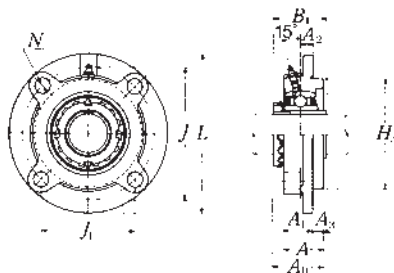

Shaft dia. mm inch	Unit number <sup>(1)(2)</sup>	Nominal dimensions												Bolt size mm inch	Bearing number
		mm inch													
		L	J	(J <sub>1</sub> )	A <sub>2</sub>	N	A <sub>3</sub>	A <sub>1</sub>	A	H <sub>3</sub>	A <sub>0</sub>	B <sub>1</sub>	F min.		
60 2 3/16 2 1/4 2 3/8	UKFC213D1;H2313X UKFC213D1;HA2313 UKFC213D1;HE2313X UKFC213D1;HS2313X	205	170	120.2	16	19	14	36	50	145	64	65	74	M16	UK213D1;H2313X UK213D1;HA2313 UK213D1;HE2313X UK213D1;HS2313X
		8 1/16	6 1/16	4 7/64	5/8	3/4	35/64	1 13/32	1 31/32	5.7087	2 39/64	2.559	2 29/32	5/8	
65 2 7/16 2 1/2	UKFC215D1;H2315X UKFC215D1;HA2315 UKFC215D1;HE2315X	220	184	130.1	18	19	16	40	56	160	71	73	84	M16	UK215D1;H2315X UK215D1;HA2315 UK215D1;HE2315X
		8 21/32	7 1/4	5 1/8	45/64	3/4	5/8	1 9/16	2 13/64	6.2992	2 51/64	2.874	3 5/16	5/8	
70 2 11/16 2 3/4	UKFC216D1;H2316X UKFC216D1;HA2316 UKFC216D1;HE2316X	240	200	141.4	18	23	16	42	58	170	73.5	78	90	M20	UK216D1;H2316X UK216D1;HA2316 UK216D1;HE2316X
		9 7/16	7 7/8	5 9/16	45/64	29/32	5/8	1 21/32	2 9/32	6.6929	2 57/64	3.071	3 17/32	3/4	
75 2 15/16 3	UKFC217D1;H2317X UKFC217D1;HA2317X UKFC217D1;HE2317X	250	208	147.1	18	23	18	45	63	180	77	82	95	M20	UK217D1;H2317X UK217D1;HA2317X UK217D1;HE2317X
		9 27/32	8 3/16	5 51/64	45/64	29/32	45/64	1 25/32	2 31/64	7.0866	3 1/2	3.228	3 3/4	3/4	
80 3 3/16	UKFC218D1;H2318X UKFC218D1;HA2318X	265	220	155.6	22	23	18	50	68	190	81.5	86	102	M20	UK218D1;H2318X UK218D1;HA2318X
		10 7/16	8 21/32	6 1/8	55/64	29/32	45/64	1 31/32	2 43/64	7.4803	3 13/64	3.386	4 1/32	3/4	

Notes <sup>(1)</sup> These numbers indicate relubricatable type. If maintenance free type is needed, please order without suffix "D1".

<sup>(2)</sup> Adapter number with suffix "X" means a narrow slot type adapter sleeve.  
In this case the lock washer with the straight inner prong should be used.

<sup>(3)</sup> If the inch series housing units with dust cover are ordered with a closed end, the suffixes E, S or A are not included.  
Example: ZM-UKFC205D1;HE2305

Remarks Please refer to page A21 for size of grease fitting.

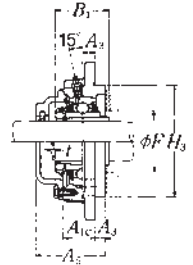
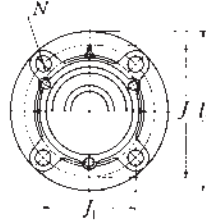
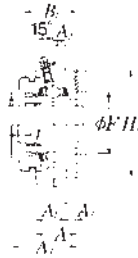
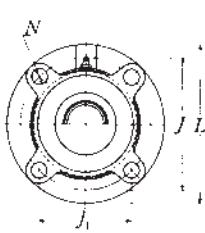

**Pressed steel dust cover type**

Open end **Z-UKFC...D1**  
 Closed end **ZM-UKFC...D1**

**Cast dust cover type**

Open end **C-UKFC...D1**  
 Closed end **CM-UKFC...D1**

Housing number	Unit number <sup>(2)</sup> pressed steel dust cover type	Unit number <sup>(2)</sup> cast dust cover type	Nominal dimensions				Mass of unit		
			mm		inch		kg lb		
			t	A <sub>4</sub>	A <sub>1c</sub>	A <sub>5</sub>	UKFC	Z(ZM)	C(CM)
FC213D1	Z(ZM)-UKFC213D1;H2313X	C(CM)-UKFC213D1;H2313X	4	76	38	89.5	6.0	6.1	7.1
FC213D1	Z(ZM)-UKFC213AD1;HA2313	C(CM)-UKFC213AD1;HA2313							
FC213D1	Z(ZM)-UKFC213ED1;HE2313X	C(CM)-UKFC213ED1;HE2313X	5/32	3	3 3/8	3 7/32	13	13	16
FC213D1	Z(ZM)-UKFC213SD1;HS2313X	C(CM)-UKFC213SD1;HS2313X							
FC215D1	—	C(CM)-UKFC215D1;H2315X	4	—	43	102	7.7	—	9.3
FC215D1	—	C(CM)-UKFC215AD1;HA2315							
FC215D1	—	C(CM)-UKFC215ED1;HE2315X	5/32	—	1 11/16	4 1/64	17	—	21
FC216D1	—	C(CM)-UKFC216D1;H2316X	4	—	43	106	9.5	—	11
FC216D1	—	C(CM)-UKFC216AD1;HA2316							
FC216D1	—	C(CM)-UKFC216ED1;HE2316X	5/32	—	1 11/16	4 11/64	21	—	24
FC217D1	—	C(CM)-UKFC217D1;H2317X	5	—	45.5	114	11	—	13
FC217D1	—	C(CM)-UKFC217AD1;HA2317X							
FC217D1	—	C(CM)-UKFC217ED1;HE2317X	1 3/6	—	1 51/64	4 31/64	24	—	29
FC218D1	—	C(CM)-UKFC218D1;H2318X	5	—	50	122	13	—	15
FC218D1	—	C(CM)-UKFC218AD1;HA2318X	1 3/6	—	1 31/32	4 51/64	29	—	33

## Round flanged unit, cast housing with spigot joint Adapter type

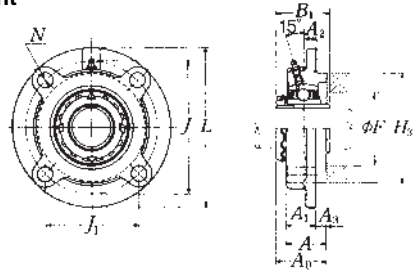

Shaft dia.  mm inch	Unit number <sup>(1)</sup> / <sub>(2)</sub> / <sub>(3)</sub>	Nominal dimensions											
		<i>L</i>	<i>J</i>	<i>(J<sub>1</sub>)</i>	<i>A<sub>2</sub></i>	<i>N</i>	<i>A<sub>3</sub></i>	<i>A<sub>1</sub></i>	<i>A</i>	<i>H<sub>3</sub></i>	<i>A<sub>0</sub></i>	<i>B<sub>1</sub></i>	<i>F</i> min.
20 3/4	<b>UKFCX05D1;H2305X</b> <b>UKFCX05D1;HE2305</b>	111 4 3/8	92 3 5/8	65.1 2 9/16	10 25/64	9.5 3/8	6 1/4	24 15/16	30 1 3/16	76 2.9921	37 1 29/64	35 1.378	30 1 1/16
25 7/8 1	<b>UKFCX06D1;H2306X</b> <b>UKFCX06D1;HS2306</b> <b>UKFCX06D1;HE2306X</b>	127 5	105 4 9/64	74.2 2 59/64	8 5/16	12 15/32	9.5 3/8	22.5 7/8	32 1 17/64	85 3.3465	40 1 37/64	38 1.496	36 1 19/32
30 1 1/8	<b>UKFCX07D1;H2307X</b> <b>UKFCX07D1;HS2307</b>	133 5 1/4	111 4 3/8	78.5 3 3/32	9 23/64	12 15/32	11 7/16	26 1 1/32	37 1 29/64	92 3.6220	44.5 1 3/4	43 1.693	40 1 1/16
35 1 1/4 1 3/8	<b>UKFCX08D1;H2308X</b> <b>UKFCX08D1;HE2308X</b> <b>UKFCX08D1;HS2308X</b>	133 5 1/4	111 4 3/8	78.5 3 3/32	9 23/64	12 15/32	11 7/16	26 1 1/32	37 1 29/64	92 3.6220	45.5 1 51/64	46 1.811	46 1 13/16
40 1 7/16 1 1/2 1 5/8	<b>UKFCX09D1;H2309X</b> <b>UKFCX09D1;HA2309</b> <b>UKFCX09D1;HE2309X</b> <b>UKFCX09D1;HS2309X</b>	155 6 3/32	130 5 1/8	91.9 3 5/8	8 5/16	14 35/64	12 15/32	25 31/32	37 1 29/64	108 4.2520	47 1 27/32	50 1.969	52 2 1/16
45 1 5/8 1 11/16 1 3/4	<b>UKFCX10D1;H2310X</b> <b>UKFCX10D1;HS2310</b> <b>UKFCX10D1;HA2310</b> <b>UKFCX10D1;HE2310X</b>	162 6 3/8	136 5 23/64	96.2 3 25/32	7 9/32	14 35/64	16 5/8	25 31/32	41 1 39/64	118 4.6457	52.5 2 1/16	55 2.165	57 2 1/4
50 1 7/8 1 9/16 2	<b>UKFCX11D1;H2311X</b> <b>UKFCX11D1;HS2311</b> <b>UKFCX11D1;HA2311</b> <b>UKFCX11D1;HE2311XY</b>	180 7 3/32	152 5 63/64	107.5 4 15/64	4 5/32	16 5/8	22 55/64	26 1 1/32	48 1 57/64	127 5.0000	57 2 1/4	59 2.323	64 2 17/32
55 2 1/8	<b>UKFCX12D1;H2312X</b> <b>UKFCX12D1;HS2312</b>	194 7 5/8	165 6 1/2	116.7 4 19/32	11 7/16	16 5/8	20 25/32	33 1 5/16	53 2 5/64	140 5.5118	64 2 33/64	62 2.441	69 2 23/32

Notes <sup>(1)</sup> These numbers indicate relubricatable type. If maintenance free type is needed, please order without suffix "D1".

<sup>(2)</sup> Adapter number with suffix "X" means a narrow slot type adapter sleeve.  
In this case the lock washer with the straight inner prong should be used.

<sup>(3)</sup> For HE2311XY, screw thread pitch different from the standard is applied, because of the thin thread section of sleeve.  
To distinguish it, a suffix "Y" is added.

Remarks Please refer to page **A21** for size of grease fitting.

<b>Bolt size</b>	<b>Bearing number</b>	<b>Housing number</b>	<b>Mass of unit</b>	
			<b>kg</b>	<b>lb</b>
<b>mm</b> <b>inch</b>				
<b>M8</b> $\frac{5}{16}$	UKX05D1;H2305X UKX05D1;HE2305	FCX05D1 FCX05D1	1.2 2.6	
<b>M10</b> $\frac{5}{8}$	UKX06D1;H2306X UKX06D1;HS2306 UKX06D1;HE2306X	FCX06D1 FCX06D1 FCX06D1	1.5 3.3	
<b>M10</b> $\frac{3}{8}$	UKX07D1;H2307X UKX07D1;HS2307	FCX07D1 FCX07D1	1.9 4.2	
<b>M10</b> $\frac{3}{8}$	UKX08D1;H2308X UKX08D1;HE2308X UKX08D1;HS2308X	FCX08D1 FCX08D1 FCX08D1	2.2 4.9	
<b>M12</b> $\frac{7}{16}$	UKX09D1;H2309X UKX09D1;HA2309 UKX09D1;HE2309X UKX09D1;HS2309X	FCX09D1 FCX09D1 FCX09D1 FCX09D1	2.7 6.0	
<b>M12</b> $\frac{7}{16}$	UKX10D1;H2310X UKX10D1;HS2310 UKX10D1;HA2310 UKX10D1;HE2310X	FCX10D1 FCX10D1 FCX10D1 FCX10D1	3.1 6.8	
<b>M14</b> $\frac{1}{2}$	UKX11D1;H2311X UKX11D1;HS2311 UKX11D1;HA2311 UKX11D1;HE2311XY	FCX11D1 FCX11D1 FCX11D1 FCX11D1	4.2 9.3	
<b>M14</b> $\frac{1}{2}$	UKX12D1;H2312X UKX12D1;HS2312	FCX12D1 FCX12D1	5.5 12	



## Round flanged unit, cast housing with spigot joint Adapter type

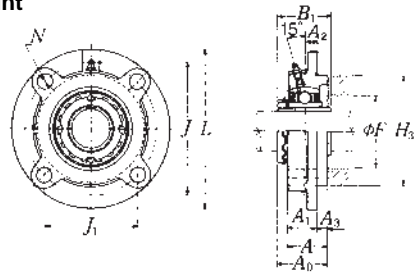

Shaft dia.  mm inch	Unit number <sup>(1)</sup> ( <sup>2</sup> )	Nominal dimensions											
		<i>L</i>	<i>J</i>	<i>(J<sub>1</sub>)</i>	<i>A<sub>2</sub></i>	<i>N</i>	mm		inch		<i>A</i>	<i>H<sub>3</sub></i>	<i>A<sub>0</sub></i>
60 2 3/16 2 1/4 2 3/8	<b>UKFCX13D1;H2313X</b> <b>UKFCX13D1;HA2313</b> <b>UKFCX13D1;HE2313X</b> <b>UKFCX13D1;HS2313X</b>	194	165	116.7	11	16	20	33	53	140	66	65	74
		7 5/8	6 1/2	4 19/32	7/16	5/8	25/32	1 5/16	2 5/64	5.5118	2 19/32	2.559	2 29/32
65 2 7/16 2 1/2	<b>UKFCX15D1;H2315X</b> <b>UKFCX15D1;HA2315</b> <b>UKFCX15D1;HE2315X</b>	222	190	134.4	12	19	22	35	57	164	71.5	73	84
		8 3/4	7 31/64	5 9/32	15/32	3/4	55/64	1 3/8	2 1/4	6.4567	2 13/16	2.874	3 5/16
70 2 11/16 2 3/4	<b>UKFCX16D1;H2316X</b> <b>UKFCX16D1;HA2316</b> <b>UKFCX16D1;HE2316X</b>	260	219	154.9	10	23	25	36	61	186	75	78	90
		10 1/4	8 5/8	6 3/32	25/64	29/32	63/64	1 13/32	2 13/32	7.3228	2 61/64	3.071	3 17/32
75 2 15/16 3	<b>UKFCX17D1;H2317X</b> <b>UKFCX17D1;HA2317X</b> <b>UKFCX17D1;HE2317X</b>	260	219	154.9	10	23	25	36	61	186	76.5	82	95
		10 1/4	8 5/8	6 3/32	25/64	29/32	63/64	1 13/32	2 13/32	7.3228	3 1/64	3.228	3 3/4
80 3 3/16	<b>UKFCX18D1;H2318X</b> <b>UKFCX18D1;HA2318X</b>	260	219	154.9	12	23	28	43	71	186	82.5	86	102
		10 1/4	8 5/8	6 3/32	15/32	29/32	1 7/64	1 11/16	2 51/64	7.3228	3 1/4	3.386	4 1/32
90	<b>UKFCX20D1;H2320X</b>	276	238	168.3	22	23	28	66	94	206	98.5	97	112

Notes <sup>(1)</sup> These numbers indicate relubricatable type. If maintenance free type is needed, please order without suffix "D1".

<sup>(2)</sup> Adapter number with suffix "X" means a narrow slot type adapter sleeve.

In this case the lock washer with the straight inner prong should be used.

Remarks Please refer to page A21 for size of grease fitting.

<b>Bolt size</b>	<b>Bearing number</b>	<b>Housing number</b>	<b>Mass of unit</b>	
			kg	lb
mm				
inch				
M14	UKX13D1;H2313X	FCX13D1	5.4	
$\frac{1}{2}$	UKX13D1;HA2313	FCX13D1		12
	UKX13D1;HE2313X	FCX13D1		
	UKX15D1;HS2313X	FCX13D1		
M16	UKX15D1;H2315X	FCX15D1	8.2	
$\frac{5}{8}$	UKX15D1;HA2315	FCX15D1		18
	UKX15D1;HE2315X	FCX15D1		
M20	UKX16D1;H2316X	FCX16D1	12	
$\frac{3}{4}$	UKX16D1;HA2316	FCX16D1		26
	UKX16D1;HE2316X	FCX16D1		
M20	UKX17D1;H2317X	FCX17D1	12	
$\frac{3}{4}$	UKX17D1;HA2317X	FCX17D1		26
	UKX17D1;HE2317X	FCX17D1		
M20	UKX18D1;H2318X	FCX18D1	12	
$\frac{3}{4}$	UKX18D1;HA2318X	FCX18D1	26	
M20	UKX20D1;H2320X	FCX20D1	18	

## Rhombus flanged unit, cast housing Adapter type

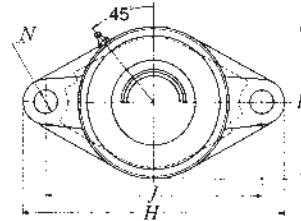
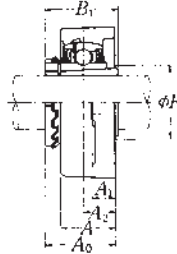
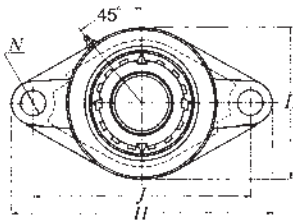

Pressed steel dust cover type

Open end **Z-UKFL...D1**

Closed end **ZM-UKFL...D1**

Shaft dia. mm inch	Unit number <sup>(1)</sup> / <sub>(2)</sub> / <sub>(3)</sub>	Nominal dimensions										Bolt size mm inch	Bearing number
		H	J	A <sub>2</sub>	A <sub>1</sub>	A	N	L	A <sub>0</sub>	B <sub>1</sub>	F min.		
20 3/4	UKFL205D1;H2305X	130	99	16	13	27	16	68	35.5	35	30	M14	UK205D1;H2305X
	UKFL205D1;HE2305	5 1/8	3 57/64	5/8	1/2	1 1/16	5/8	2 11/16	1 25/64	1.378	1 1/8	1/2	UK205D1;HE2305
25 7/8 1	UKFL206D1;H2306X	148	117	18	13	31	16	80	39	38	36	M14	UK206D1;H2306X
	UKFL206D1;HS2306 UKFL206D1;HE2306X	5 13/16	4 39/64	45/64	1/2	1 7/32	5/8	3 5/32	1 17/32	1.496	1 13/32	1/2	UK206D1;HS2306 UK206D1;HE2306X
30 1 1/8	UKFL207D1;H2307X	161	130	19	15	34	16	90	42.5	43	40	M14	UK207D1;H2307X
	UKFL207D1;HS2307	6 11/32	5 1/8	3/4	1 19/32	1 11/32	5/8	3 17/32	1 43/64	1.693	1 1/8	1/2	UK207D1;HS2307
35 1 1/4 1 3/8	UKFL208D1;H2308X	175	144	21	15	36	16	100	46.5	46	46	M14	UK208D1;H2308X
	UKFL208D1;HE2308X UKFL208D1;HS2308X	6 7/8	5 43/64	53/64	1 19/32	1 13/32	5/8	3 15/16	1 53/64	1.811	1 13/16	1/2	UK208D1;HE2308X UK208D1;HS2308X
40 1 7/16 1 1/2 1 5/8	UKFL209D1;H2309X	188	148	22	16	38	19	108	48.5	50	52	M16	UK209D1;H2309X
	UKFL209D1;HA2309 UKFL209D1;HE2309X UKFL209D1;HS2309X	7 13/32	5 53/64	55/64	5/8	1 1/2	3/4	4 1/4	1 29/32	1.969	2 1/16	5/8	UK209D1;HA2309 UK209D1;HE2309X UK209D1;HS2309X
45 1 5/8 1 11/16 1 3/4	UKFL210D1;H2310X	197	157	22	16	40	19	115	50	55	57	M16	UK210D1;H2310X
	UKFL210D1;HS2310 UKFL210D1;HA2310 UKFL210D1;HE2310X	7 3/4	6 3/16	55/64	5/8	1 9/16	3/4	4 17/32	1 31/32	2.165	2 1/4	5/8	UK210D1;HS2310 UK210D1;HA2310 UK210D1;HE2310X
50 1 7/8 1 13/16 2	UKFL211D1;H2311X	224	184	25	18	43	19	130	54.5	59	64	M16	UK211D1;H2311X
	UKFL211D1;HS2311 UKFL211D1;HA2311 UKFL211D1;HE2311XY	8 13/16	7 1/4	63/64	23/32	1 11/16	3/4	5 1/8	2 9/64	2.323	2 17/32	5/8	UK211D1;HS2311 UK211D1;HA2311 UK211D1;HE2311XY
55 2 1/8	UKFL212D1;H2312X	250	202	29	18	48	23	140	61	62	69	M20	UK212D1;H2312X
	UKFL212D1;HS2312	9 27/32	7 61/64	1 1/4	23/32	1 7/8	29/32	5 1/2	2 13/32	2.441	2 23/32	3/4	UK212D1;HS2312

Notes <sup>(1)</sup> These numbers indicate relubricatable type. If maintenance free type is needed, please order without suffix "D1".

<sup>(2)</sup> Adapter number with suffix "X" means a narrow slot type adapter sleeve.  
In this case the lock washer with the straight inner prong should be used.

<sup>(3)</sup> For HE2311XY, screw thread pitch different from the standard is applied, because of the thin thread section of sleeve.  
To distinguish it, a suffix "Y" is added.

<sup>(4)</sup> If the inch series housing units with dust cover are ordered with a closed end, the suffixes E, S or A are not included.  
Example: ZM-UKFL205D1;HE2305

Remarks Please refer to page A21 for size of grease fitting.

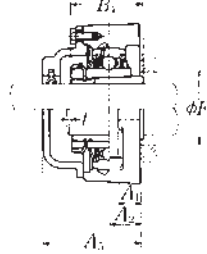
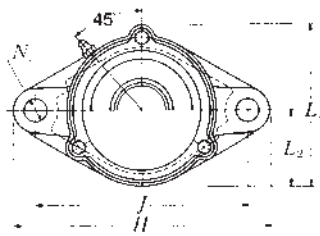
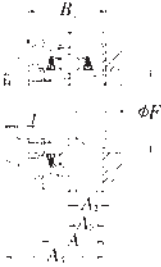

**Cast dust cover type**  
 Open end **C-UKFL...D1**  
 Closed end **CM-UKFL...D1**

Housing number	Unit number (*) pressed steel dust cover type	Unit number (*) cast dust cover type	Nominal dimensions					Mass of unit		
			mm inch					kg lb		
			t max.	A <sub>4</sub>	A <sub>5</sub>	L <sub>1</sub>	L <sub>2</sub>	UKFL	Z(ZM)	C(CM)
FL205D1 FL205D1	Z(ZM)-UKFL205D1;H2305X Z(ZM)-UKFL205ED1;HE2305	C(CM)-UKFL205D1;H2305X C(CM)-UKFL205ED1;HE2305	2 5/64	40 1 19/32	51 2	74 2 29/32	34 1 11/32	0.6 1.3	0.7 1.5	0.8 1.8
FL206D1 FL206D1 FL206D1	Z(ZM)-UKFL206D1;H2306X Z(ZM)-UKFL206SD1;HS2306 Z(ZM)-UKFL206ED1;HE2306X	C(CM)-UKFL206D1;H2306X C(CM)-UKFL206SD1;HS2306 C(CM)-UKFL206ED1;HE2306X	2 5/64	45 1 3/4	56 2 1/32	85 3 1/2	40 1 9/16	0.9 2.0	1.0 2.2	1.2 2.9
FL207D1 FL207D1	Z(ZM)-UKFL207D1;H2307X Z(ZM)-UKFL207SD1;HS2307	C(CM)-UKFL207D1;H2307X C(CM)-UKFL207SD1;HS2307	3 1/8	49 1 15/16	59 2 5/16	97 3 13/16	45 1 25/32	1.3 2.9	1.3 2.9	1.6 3.5
FL208D1 FL208D1 FL208D1	Z(ZM)-UKFL208D1;H2308X Z(ZM)-UKFL208ED1;HE2308X Z(ZM)-UKFL208SD1;HS2308X	C(CM)-UKFL208D1;H2308X C(CM)-UKFL208ED1;HE2308X C(CM)-UKFL208SD1;HS2308X	3 1/8	56 2 3/16	66 2 19/32	106 4 3/16	50 1 31/32	1.6 3.5	1.7 3.7	2.1 4.6
FL209D1 FL209D1 FL209D1 FL209D1	Z(ZM)-UKFL209D1;H2309X Z(ZM)-UKFL209AD1;HA2309 Z(ZM)-UKFL209ED1;HE2309X Z(ZM)-UKFL209SD1;HS2309X	C(CM)-UKFL209D1;H2309X C(CM)-UKFL209AD1;HA2309 C(CM)-UKFL209ED1;HE2309X C(CM)-UKFL209SD1;HS2309X	3 1/8	57 2 1/4	70 2 3/4	113 4 7/16	54 2 1/8	2.0 4.4	2.1 4.6	2.5 5.7
FL210D1 FL210D1 FL210D1 FL210D1	Z(ZM)-UKFL210D1;H2310X Z(ZM)-UKFL210SD1;HS2310 Z(ZM)-UKFL210AD1;HA2310 Z(ZM)-UKFL210ED1;HE2310X	C(CM)-UKFL210D1;H2310X C(CM)-UKFL210SD1;HS2310 C(CM)-UKFL210AD1;HA2310 C(CM)-UKFL210ED1;HE2310X	3 1/8	60 2 3/8	72 2 27/32	120 4 23/32	58 2 9/32	2.2 4.9	2.4 5.3	2.9 6.4
FL211D1 FL211D1 FL211D1 FL211D1	Z(ZM)-UKFL211D1;H2311X Z(ZM)-UKFL211SD1;HS2311 Z(ZM)-UKFL211AD1;HA2311 Z(ZM)-UKFL211ED1;HE2311XY	C(CM)-UKFL211D1;H2311X C(CM)-UKFL211SD1;HS2311 C(CM)-UKFL211AD1;HA2311 C(CM)-UKFL211ED1;HE2311XY	4 5/32	64 2 1/2	75 2 15/16	133 5 1/4	65 2 9/16	3.1 6.8	3.4 7.5	3.7 8.2
FL212D1 FL212D1	Z(ZM)-UKFL212D1;H2312X Z(ZM)-UKFL212SD1;HS2312	C(CM)-UKFL212D1;H2312X C(CM)-UKFL212SD1;HS2312	4 5/32	74 2 29/32	86 3 3/8	144 5 21/32	70 2 3/4	3.9 8.6	4.2 9.3	4.7 10

## Rhombus flanged unit, cast housing Adapter type

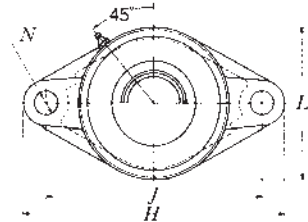
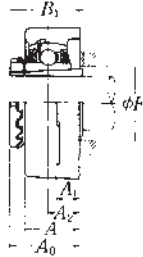
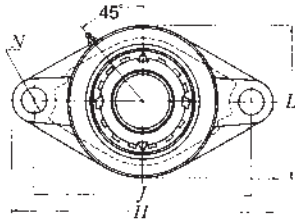

**Pressed steel dust cover type**  
Open end **Z-UKFL...D1**  
Closed end **ZM-UKFL...D1**

Shaft dia. mm inch	Unit number <sup>(1)</sup> ( <sup>2</sup> )	Nominal dimensions										Bolt size mm inch	Bearing number
		H	J	A <sub>2</sub>	A <sub>1</sub>	mm inch		L	A <sub>0</sub>	B <sub>1</sub>	F min.		
60 2 3/16 2 1/4 2 3/8	<b>UKFL213D1;H2313X</b> <b>UKFL213D1;HA2313</b> <b>UKFL213D1;HE2313X</b> <b>UKFL213D1;HS2313X</b>	258	210	30	22	50	23	155	64	65	74	M20	UK213D1;H2313X UK213D1;HA2313 UK213D1;HE2313X UK213D1;HS2313X
65 2 7/16 2 1/2	<b>UKFL215D1;H2315X</b> <b>UKFL215D1;HA2315</b> <b>UKFL215D1;HE2315X</b>	275	225	34	22	56	23	165	71	73	84	M20	UK215D1;H2315X UK215D1;HA2315 UK215D1;HE2315X
70 2 11/16 2 3/4	<b>UKFL216D1;H2316X</b> <b>UKFL216D1;HA2316</b> <b>UKFL216D1;HE2316X</b>	290	233	34	22	58	25	180	73.5	78	90	M22	UK216D1;H2316X UK216D1;HA2316 UK216D1;HE2316X
75 2 15/16 3	<b>UKFL217D1;H2317X</b> <b>UKFL217D1;HA2317X</b> <b>UKFL217D1;HE2317X</b>	305	248	36	24	63	25	190	77	82	95	M22	UK217D1;H2317X UK217D1;HA2317X UK217D1;HE2317X
80 3 3/16	<b>UKFL218D1;H2318X</b> <b>UKFL218D1;HA2318X</b>	320	265	40	24	68	25	205	81.5	86	102	M22	UK218D1;H2318X UK218D1;HA2318X

**Notes** <sup>(1)</sup> These numbers indicate relubricatable type. If maintenance free type is needed, please order without suffix "D1".

<sup>(2)</sup> Adapter number with suffix "X" means a narrow slot type adapter sleeve.  
In this case the lock washer with the straight inner prong should be used.

<sup>(3)</sup> If the inch series housing units with dust cover are ordered with a closed end, the suffixes E, S or A are not included.  
Example: ZM-UKFL205D1;HE2305

**Remarks** Please refer to page **A21** for size of grease fitting.

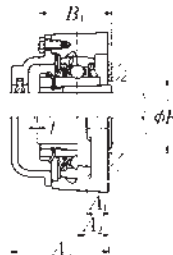
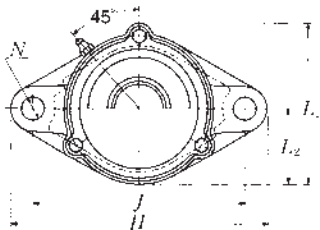
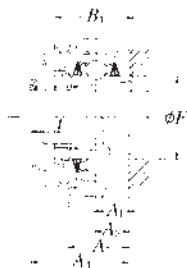

**Cast dust cover type**  
 Open end **C-UKFL...D1**  
 Closed end **CM-UKFL...D1**

Housing number	Unit number <sup>(2)</sup> pressed steel dust cover type	Unit number <sup>(2)</sup> cast dust cover type	Nominal dimensions					Mass of unit		
			<i>t</i> max.	<i>A</i> <sub>4</sub>	<i>A</i> <sub>5</sub>	<i>L</i> <sub>1</sub>	<i>L</i> <sub>2</sub>	UKFL	Z(ZM)	C(CM)
FL213D1	Z(ZM)-UKFL213D1;H2313X	C(CM)-UKFL213D1;H2313X	4	76	90	157	78	5.0	5.4	6.0
FL213D1	Z(ZM)-UKFL213AD1;HA2313	C(CM)-UKFL213AD1;HA2313	5/32	3	3 17/32	6 3/16	3 1/16	11	12	13
FL213D1	Z(ZM)-UKFL213ED1;HE2313X	C(CM)-UKFL213ED1;HE2313X	5/32	3	3 17/32	6 3/16	3 1/16	11	12	13
FL213D1	Z(ZM)-UKFL213SD1;HS2313X	C(CM)-UKFL213SD1;HS2313X	5/32	3	3 17/32	6 3/16	3 1/16	11	12	13
FL215D1	—	C(CM)-UKFL215D1;H2315X	4	—	102	169	82	6.2	—	7.6
FL215D1	—	C(CM)-UKFL215AD1;HA2315	5/32	—	4 1/32	6 21/32	3 3/32	14	—	17
FL215D1	—	C(CM)-UKFL215ED1;HE2315X	5/32	—	4 1/32	6 21/32	3 3/32	14	—	17
FL216D1	—	C(CM)-UKFL216D1;H2316X	4	—	106	183	90	7.9	—	9.3
FL216D1	—	C(CM)-UKFL216AD1;HA2316	5/32	—	4 3/16	7 7/32	3 17/32	17	—	21
FL216D1	—	C(CM)-UKFL216ED1;HE2316X	5/32	—	4 3/16	7 7/32	3 17/32	17	—	21
FL217D1	—	C(CM)-UKFL217D1;H2317X	5	—	114	192	95	9.2	—	11
FL217D1	—	C(CM)-UKFL217AD1;HA2317X	13/64	—	4 1/2	7 9/16	3 3/4	20	—	24
FL217D1	—	C(CM)-UKFL217ED1;HE2317X	13/64	—	4 1/2	7 9/16	3 3/4	20	—	24
FL218D1	—	C(CM)-UKFL218D1;H2318X	5	—	122	205	102	11	—	13
FL218D1	—	C(CM)-UKFL218AD1;HA2318X	13/64	—	4 13/16	8 1/16	4 1/32	24	—	29

## Rhombus flanged unit, cast housing Adapter type

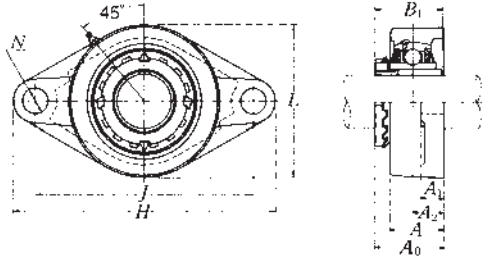

Shaft dia.  mm inch	Unit number <sup>(1)</sup> ( <sup>2</sup> )( <sup>3</sup> )	Nominal dimensions									Bolt size  mm inch
		mm inch									
		H	J	A <sub>2</sub>	A <sub>1</sub>	A	N	L	A <sub>0</sub>	B <sub>1</sub>	
20 $\frac{3}{4}$	UKFL305D1;H2305X UKFL305D1;HE2305	150 $5\frac{29}{32}$	113 $4\frac{29}{64}$	16 $\frac{5}{8}$	13 $\frac{1}{2}$	29 $1\frac{5}{32}$	19 $\frac{3}{4}$	80 $3\frac{5}{32}$	37 $1\frac{29}{64}$	35 1.378	M16 $\frac{5}{8}$
25 $\frac{7}{8}$ 1	UKFL306D1;H2306X UKFL306D1;HS2306 UKFL306D1;HE2306X	180 $7\frac{3}{32}$	134 $5\frac{9}{32}$	18 $\frac{45}{64}$	15 $\frac{19}{32}$	32 $1\frac{1}{4}$	23 $\frac{29}{32}$	90 $3\frac{17}{32}$	40.5 $1\frac{19}{32}$	38 1.496	M20 $\frac{3}{4}$
30 $1\frac{1}{8}$	UKFL307D1;H2307X UKFL307D1;HS2307	185 $7\frac{9}{32}$	141 $5\frac{35}{64}$	20 $\frac{25}{32}$	16 $\frac{5}{8}$	36 $1\frac{13}{32}$	23 $\frac{29}{32}$	100 $3\frac{15}{16}$	45.5 $1\frac{51}{64}$	43 1.693	M20 $\frac{3}{4}$
35 $1\frac{1}{4}$ $1\frac{3}{8}$	UKFL308D1;H2308X UKFL308D1;HE2308X UKFL308D1;HS2308X	200 $7\frac{7}{8}$	158 $6\frac{7}{32}$	23 $\frac{29}{32}$	17 $\frac{21}{32}$	40 $1\frac{9}{16}$	23 $\frac{29}{32}$	112 $4\frac{13}{32}$	50 $1\frac{31}{32}$	46 1.811	M20 $\frac{3}{4}$
40 $1\frac{7}{16}$ $1\frac{1}{2}$ $1\frac{5}{8}$	UKFL309D1;H2309X UKFL309D1;HA2309 UKFL309D1;HE2309X UKFL309D1;HS2309X	230 $9\frac{1}{16}$	177 $6\frac{31}{32}$	25 $\frac{63}{64}$	18 $\frac{23}{32}$	44 $1\frac{23}{32}$	25 $\frac{63}{64}$	125 $4\frac{29}{32}$	54.5 $2\frac{9}{64}$	50 1.969	M22 $\frac{7}{8}$
45 $1\frac{5}{8}$ $1\frac{11}{16}$ $1\frac{3}{4}$	UKFL310D1;H2310X UKFL310D1;HS2310 UKFL310D1;HA2310 UKFL310D1;HE2310X	240 $9\frac{7}{16}$	187 $7\frac{23}{64}$	28 $1\frac{7}{64}$	19 $\frac{3}{4}$	48 $1\frac{7}{8}$	25 $\frac{63}{64}$	140 $5\frac{1}{2}$	60.5 $2\frac{3}{8}$	55 2.165	M22 $\frac{7}{8}$
50 $1\frac{7}{8}$ $1\frac{5}{16}$ 2	UKFL311D1;H2311X UKFL311D1;HS2311 UKFL311D1;HA2311 UKFL311D1;HE2311XY	250 $9\frac{27}{32}$	198 $7\frac{5}{64}$	30 $1\frac{3}{16}$	20 $\frac{25}{32}$	52 $2\frac{1}{16}$	25 $\frac{63}{64}$	150 $5\frac{29}{32}$	64 $2\frac{39}{64}$	59 2.323	M22 $\frac{7}{8}$
55 $2\frac{1}{8}$	UKFL312D1;H2312X UKFL312D1;HS2312	270 $10\frac{5}{8}$	212 $8\frac{11}{32}$	33 $1\frac{19}{64}$	22 $\frac{7}{8}$	56 $2\frac{7}{32}$	31 $1\frac{7}{32}$	160 $6\frac{5}{16}$	69.5 $2\frac{27}{64}$	62 2.441	M27 1

Notes <sup>(1)</sup> These numbers indicate relubricatable type. If maintenance free type is needed, please order without suffix "D1".

<sup>(2)</sup> Adapter number with suffix "X" means a narrow slot type adapter sleeve.  
In this case the lock washer with the straight inner prong should be used.

<sup>(3)</sup> For HE2311XY, screw thread pitch different from the standard is applied, because of the thin thread section of sleeve.  
To distinguish it, a suffix "Y" is added.

<sup>(4)</sup> If the inch series housing units with dust cover are ordered with a closed end, the suffixes E, S or A are not included.  
Example: CM-UKFL305D1;HE2305

Remarks Please refer to page A21 for size of grease fitting.

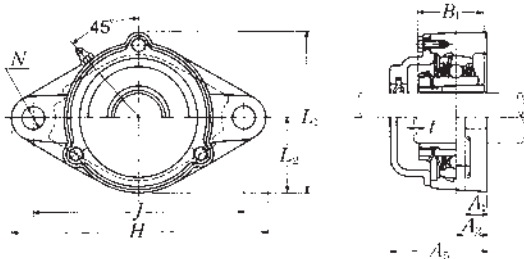

**Cast dust cover type**  
 Open end **C-UKFL...D1**  
 Closed end **CM-UKFL...D1**

Bearing number	Housing number	Unit number (*) cast dust cover type	Nominal dimensions				Mass of unit	
			<i>t</i> max.	<i>A</i> <sub>5</sub>	<i>L</i> <sub>1</sub>	<i>L</i> <sub>2</sub>	UKFL	C(CM)
UK305D1;H2305X UK305D1;HE2305	FL305D1 FL305D1	<b>C(CM)-UKFL305D1;H2305X</b> <b>C(CM)-UKFL305ED1;HE2305</b>	2 <sup>5</sup> / <sub>64</sub>	56 2 <sup>7</sup> / <sub>32</sub>	86 3 <sup>3</sup> / <sub>8</sub>	40 1 <sup>9</sup> / <sub>16</sub>	1.0 2.2	1.3 2.9
UK306D1;H2306X UK306D1;HS2306 UK306D1;HE2306X	FL306D1 FL306D1 FL306D1	<b>C(CM)-UKFL306D1;H2306X</b> <b>C(CM)-UKFL306SD1;HS2306</b> <b>C(CM)-UKFL306ED1;HE2306X</b>	2 <sup>5</sup> / <sub>64</sub>	60 2 <sup>3</sup> / <sub>8</sub>	101 3 <sup>31</sup> / <sub>32</sub>	45 1 <sup>29</sup> / <sub>32</sub>	1.5 3.3	1.8 4.0
UK307D1;H2307X UK307D1;HS2307	FL307D1 FL307D1	<b>C(CM)-UKFL307D1;H2307X</b> <b>C(CM)-UKFL307SD1;HS2307</b>	3 <sup>1</sup> / <sub>8</sub>	68 2 <sup>11</sup> / <sub>16</sub>	110 4 <sup>11</sup> / <sub>32</sub>	50 1 <sup>3</sup> / <sub>32</sub>	1.8 4.0	2.2 4.9
UK308D1;H2308X UK308D1;HE2308X UK308D1;HS2308X	FL308D1 FL308D1 FL308D1	<b>C(CM)-UKFL308D1;H2308X</b> <b>C(CM)-UKFL308ED1;HE2308X</b> <b>C(CM)-UKFL308SD1;HS2308X</b>	3 <sup>1</sup> / <sub>8</sub>	76 3	122 4 <sup>13</sup> / <sub>16</sub>	56 2 <sup>7</sup> / <sub>32</sub>	2.2 4.9	3.0 6.6
UK309D1;H2309X UK309D1;HA2309 UK309D1;HE2309X UK309D1;HS2309X	FL309D1 FL309D1 FL309D1 FL309D1	<b>C(CM)-UKFL309D1;H2309X</b> <b>C(CM)-UKFL309AD1;HA2309</b> <b>C(CM)-UKFL309ED1;HE2309X</b> <b>C(CM)-UKFL309SD1;HS2309X</b>	3 <sup>1</sup> / <sub>8</sub>	80 3 <sup>5</sup> / <sub>32</sub>	135 5 <sup>5</sup> / <sub>16</sub>	62 2 <sup>7</sup> / <sub>16</sub>	3.0 6.6	3.9 8.6
UK310D1;H2310X UK310D1;HS2310 UK310D1;HA2310 UK310D1;HE2310X	FL310D1 FL310D1 FL310D1 FL310D1	<b>C(CM)-UKFL310D1;H2310X</b> <b>C(CM)-UKFL310SD1;HS2310</b> <b>C(CM)-UKFL310AD1;HA2310</b> <b>C(CM)-UKFL310ED1;HE2310X</b>	3 <sup>1</sup> / <sub>8</sub>	88 3 <sup>15</sup> / <sub>32</sub>	152 5 <sup>31</sup> / <sub>32</sub>	70 2 <sup>3</sup> / <sub>4</sub>	4.1 9.0	5.1 11
UK311D1;H2311X UK311D1;HS2311 UK311D1;HA2311 UK311D1;HE2311XY	FL311D1 FL311D1 FL311D1 FL311D1	<b>C(CM)-UKFL311D1;H2311X</b> <b>C(CM)-UKFL311SD1;HS2311</b> <b>C(CM)-UKFL311AD1;HA2311</b> <b>C(CM)-UKFL311ED1;HE2311XY</b>	4 <sup>5</sup> / <sub>32</sub>	92 3 <sup>5</sup> / <sub>8</sub>	162 6 <sup>3</sup> / <sub>8</sub>	75 2 <sup>15</sup> / <sub>16</sub>	4.6 10	6.0 13
UK312D1;H2312X UK312D1;HS2312	FL312D1 FL312D1	<b>C(CM)-UKFL312D1;H2312X</b> <b>C(CM)-UKFL312SD1;HS2312</b>	4 <sup>5</sup> / <sub>32</sub>	100 3 <sup>15</sup> / <sub>16</sub>	175 6 <sup>7</sup> / <sub>8</sub>	80 3 <sup>5</sup> / <sub>32</sub>	5.7 13	7.7 17



## Rhombus flanged unit, cast housing Adapter type

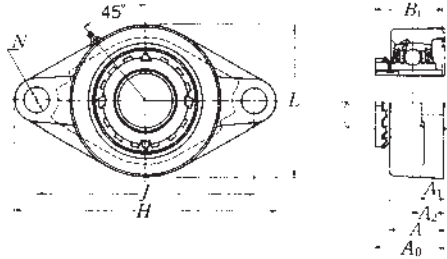

Shaft dia. mm inch	Unit number <sup>(1)(2)</sup>	Nominal dimensions									Bolt size mm inch
		mm inch									
		H	J	A <sub>2</sub>	A <sub>1</sub>	A	N	L	A <sub>0</sub>	B <sub>1</sub>	
60 2 <sup>3</sup> / <sub>16</sub> 2 <sup>1</sup> / <sub>4</sub> 2 <sup>3</sup> / <sub>8</sub>	UKFL313D1;H2313X UKFL313D1;HA2313 UKFL313D1;HE2313X UKFL313D1;HS2313X	295 11 <sup>5</sup> / <sub>8</sub>	240 9 <sup>59</sup> / <sub>64</sub>	33 1 <sup>19</sup> / <sub>64</sub>	25 3 <sup>1</sup> / <sub>32</sub>	58 2 <sup>3</sup> / <sub>32</sub>	31 1 <sup>7</sup> / <sub>32</sub>	175 6 <sup>7</sup> / <sub>8</sub>	71.5 2 <sup>19</sup> / <sub>16</sub>	65 2.559	M27 1
65 2 <sup>7</sup> / <sub>16</sub> 2 <sup>1</sup> / <sub>2</sub>	UKFL315D1;H2315X UKFL315D1;HA2315 UKFL315D1;HE2315X	320 12 <sup>19</sup> / <sub>32</sub>	260 10 <sup>15</sup> / <sub>64</sub>	39 1 <sup>17</sup> / <sub>32</sub>	30 1 <sup>3</sup> / <sub>16</sub>	66 2 <sup>19</sup> / <sub>32</sub>	35 1 <sup>3</sup> / <sub>8</sub>	195 7 <sup>11</sup> / <sub>16</sub>	81.5 3 <sup>13</sup> / <sub>64</sub>	73 2.874	M30 1 <sup>1</sup> / <sub>8</sub>
70 2 <sup>11</sup> / <sub>16</sub> 2 <sup>3</sup> / <sub>4</sub>	UKFL316D1;H2316X UKFL316D1;HA2316 UKFL316D1;HE2316X	355 13 <sup>31</sup> / <sub>32</sub>	285 11 <sup>7</sup> / <sub>32</sub>	38 1 <sup>1</sup> / <sub>2</sub>	32 1 <sup>1</sup> / <sub>4</sub>	68 2 <sup>11</sup> / <sub>16</sub>	38 1 <sup>1</sup> / <sub>2</sub>	210 8 <sup>3</sup> / <sub>32</sub>	84 3 <sup>5</sup> / <sub>16</sub>	78 3.071	M33 1 <sup>1</sup> / <sub>4</sub>
75 2 <sup>15</sup> / <sub>16</sub> 3	UKFL317D1;H2317X UKFL317D1;HA2317X UKFL317D1;HE2317X	370 14 <sup>9</sup> / <sub>16</sub>	300 11 <sup>19</sup> / <sub>16</sub>	44 1 <sup>47</sup> / <sub>64</sub>	32 1 <sup>1</sup> / <sub>4</sub>	74 2 <sup>29</sup> / <sub>32</sub>	38 1 <sup>1</sup> / <sub>2</sub>	220 8 <sup>21</sup> / <sub>32</sub>	92 3 <sup>5</sup> / <sub>6</sub>	82 3.228	M33 1 <sup>1</sup> / <sub>4</sub>
80 3 <sup>3</sup> / <sub>16</sub>	UKFL318D1;H2318X UKFL318D1;HA2318X	385 15 <sup>5</sup> / <sub>32</sub>	315 12 <sup>13</sup> / <sub>32</sub>	44 1 <sup>47</sup> / <sub>64</sub>	36 1 <sup>13</sup> / <sub>32</sub>	76 3	38 1 <sup>1</sup> / <sub>2</sub>	235 9 <sup>1</sup> / <sub>4</sub>	94 3 <sup>45</sup> / <sub>64</sub>	86 3.386	M33 1 <sup>1</sup> / <sub>4</sub>
85 3 <sup>1</sup> / <sub>4</sub>	UKFL319D1;H2319X UKFL319D1;HE2319X	405 15 <sup>15</sup> / <sub>16</sub>	330 12 <sup>63</sup> / <sub>64</sub>	59 2 <sup>21</sup> / <sub>64</sub>	40 1 <sup>9</sup> / <sub>16</sub>	94 3 <sup>11</sup> / <sub>16</sub>	41 1 <sup>39</sup> / <sub>64</sub>	250 9 <sup>27</sup> / <sub>32</sub>	111.5 4 <sup>25</sup> / <sub>64</sub>	90 3.543	M36 1 <sup>3</sup> / <sub>8</sub>
90 3 <sup>7</sup> / <sub>16</sub> 3 <sup>1</sup> / <sub>2</sub>	UKFL320D1;H2320X UKFL320D1;HA2320 UKFL320D1;HE2320X	440 17 <sup>5</sup> / <sub>16</sub>	360 14 <sup>11</sup> / <sub>64</sub>	59 2 <sup>21</sup> / <sub>64</sub>	40 1 <sup>9</sup> / <sub>16</sub>	94 3 <sup>11</sup> / <sub>16</sub>	44 1 <sup>17</sup> / <sub>64</sub>	270 10 <sup>5</sup> / <sub>8</sub>	115.5 4 <sup>35</sup> / <sub>64</sub>	97 3.819	M39 1 <sup>1</sup> / <sub>2</sub>
100	UKFL322D1;H2322X	470	390	60	42	96	44	300	121	105	M39
110	UKFL324D1;H2324	520	430	65	48	110	47	330	130	112	M42
115	UKFL326D1;H2326	550	460	65	50	115	47	360	133	121	M42
125	UKFL328D1;H2328	600	500	75	60	125	51	400	146.5	131	M45

Notes <sup>(1)</sup> These numbers indicate relubricatable type. If maintenance free type is needed, please order without suffix "D1".

<sup>(2)</sup> Adapter number with suffix "X" means a narrow slot type adapter sleeve.  
In this case the lock washer with the straight inner prong should be used.

<sup>(3)</sup> If the inch series housing units with dust cover are ordered with a closed end, the suffixes E, S or A are not included.  
Example: CM-UKFL305D1;HE2305

Remarks Please refer to page A21 for size of grease fitting.

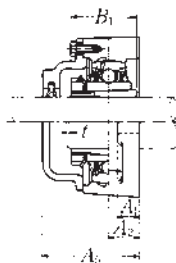
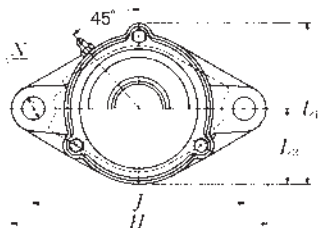

**Cast dust cover type**  
 Open end **C-UKFL...D1**  
 Closed end **CM-UKFL...D1**

Bearing number	Housing number	Unit number <sup>(*)</sup> cast dust cover type	Nominal dimensions				Mass of unit	
			<i>t</i> max.	<i>A</i> <sub>5</sub> mm	<i>L</i> <sub>1</sub> inch	<i>L</i> <sub>2</sub> mm	UKFL kg	C(CM) lb
UK313D1;H2313X	FL313D1	<b>C(CM)-UKFL313D1;H2313X</b>	4	103	189	88	7.4	9.8
UK313D1;HA2313	FL313D1	<b>C(CM)-UKFL313AD1;HA2313</b>						
UK313D1;HE2313X	FL313D1	<b>C(CM)-UKFL313ED1;HE2313X</b>	5/32	4 1/16	7 7/16	3 15/32	16	22
UK313D1;HS2313X	FL313D1	<b>C(CM)-UKFL313SD1;HS2313X</b>						
UK315D1;H2315X	FL315D1	<b>C(CM)-UKFL315D1;H2315X</b>	4	114	210	98	9.9	13
UK315D1;HA2315	FL315D1	<b>C(CM)-UKFL315AD1;HA2315</b>						
UK315D1;HE2315X	FL315D1	<b>C(CM)-UKFL315ED1;HE2315X</b>	5/32	4 1/2	8 9/32	3 7/32	22	29
UK316D1;H2316X	FL316D1	<b>C(CM)-UKFL316D1;H2316X</b>	4	116	222	105	13	17
UK316D1;HA2316	FL316D1	<b>C(CM)-UKFL316AD1;HA2316</b>						
UK316D1;HE2316X	FL316D1	<b>C(CM)-UKFL316ED1;HE2316X</b>	5/32	4 9/16	8 3/4	4 1/8	29	37
UK317D1;H2317X	FL317D1	<b>C(CM)-UKFL317D1;H2317X</b>	5	127	234	110	15	18
UK317D1;HA2317X	FL317D1	<b>C(CM)-UKFL317AD1;HA2317X</b>						
UK317D1;HE2317X	FL317D1	<b>C(CM)-UKFL317ED1;HE2317X</b>	13/64	5	9 7/32	4 11/32	33	40
UK318D1;H2318X	FL318D1	<b>C(CM)-UKFL318D1;H2318X</b>	5	129	247	118	18	22
UK318D1;HA2318X	FL318D1	<b>C(CM)-UKFL318AD1;HA2318X</b>	13/64	5 3/32	9 23/32	4 21/32	40	49
UK319D1;H2319X	FL319D1	<b>C(CM)-UKFL319D1;H2319X</b>	5	149	260	125	22	27
UK319D1;HE2319X	FL319D1	<b>C(CM)-UKFL319ED1;HE2319X</b>	13/64	5 7/8	10 1/4	4 29/32	49	60
UK320D1;H2320X	FL320D1	<b>C(CM)-UKFL320D1;H2320X</b>	5	154	280	135	26	32
UK320D1;HA2320	FL320D1	<b>C(CM)-UKFL320AD1;HA2320</b>						
UK320D1;HE2320X	FL320D1	<b>C(CM)-UKFL320ED1;HE2320X</b>	13/64	6 1/16	11 1/2	5 5/16	57	71
UK322D1;H2322X	FL322D1	<b>C(CM)-UKFL322D1;H2322X</b>	5	160	315	150	34	41
UK324D1;H2324	FL324D1	<b>C(CM)-UKFL324D1;H2324</b>	5	172	342	165	47	52
UK326D1;H2326	FL326D1	<b>C(CM)-UKFL326D1;H2326</b>	6	178	376	180	58	65
UK328D1;H2328	FL328D1	<b>C(CM)-UKFL328D1;H2328</b>	6	192	410	200	82	90

## Rhombus flanged unit, cast housing Adapter type

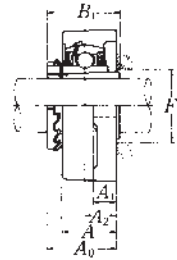
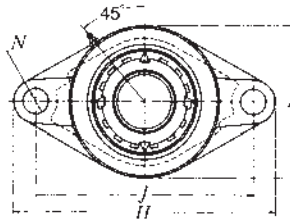

Shaft dia. mm inch	Unit number <sup>(1)(2)</sup>	Nominal dimensions									
		<i>H</i>	<i>J</i>	<i>A</i> <sub>2</sub>	<i>A</i> <sub>1</sub>	<i>A</i>		<i>L</i>	<i>A</i> <sub>0</sub>	<i>B</i> <sub>1</sub>	<i>F</i> min.
		mm inch									
20 3/4	UKFLX05D1;H2305X	141	117	18	13	30	12	83	39	35	–
	UKFLX05D1;HE2305	5 9/16	4 39/64	45/64	1/2	1 3/16	15/32	3 9/32	1 17/32	1.378	–
25 7/8 1	UKFLX06D1;H2306X	156	130	19	15	34	16	95	41.5	38	–
	UKFLX06D1;HS2306 UKFLX06D1;HE2306X	6 5/32	5 1/8	3/4	19/32	1 11/32	5/8	3 3/4	1 41/64	1.496	–
30 1 1/8	UKFLX07D1;H2307X	171	144	21	16	38	16	105	45.5	43	–
	UKFLX07D1;HS2307	6 23/32	5 43/64	53/64	5/8	1 1/2	5/8	4 1/8	1 51/64	1.693	–
35 1 1/4 1 3/8	UKFLX08D1;H2308X	179	148	22	16	40	16	111	47.5	46	46
	UKFLX08D1;HE2308X UKFLX08D1;HS2308X	7 1/16	5 53/64	55/64	5/8	1 9/16	5/8	4 3/8	1 7/8	1.811	1 13/16
40 1 7/16 1 1/2 1 5/8	UKFLX09D1;H2309X	189	157	23	16	40	16	116	50	50	52
	UKFLX09D1;HA2309										
	UKFLX09D1;HE2309X UKFLX09D1;HS2309X	7 7/16	6 3/16	29/32	5/8	1 9/16	5/8	4 9/16	1 31/32	1.969	2 1/16
45 1 5/8 1 11/16 1 3/4	UKFLX10D1;H2310X	216	184	26	18	44	19	133	55.5	55	57
	UKFLX10D1;HS2310										
	UKFLX10D1;HA2310 UKFLX10D1;HE2310X	8 1/2	7 1/4	1 1/32	23/32	1 23/32	3/4	5 1/4	2 3/16	2.165	2 1/4

Notes <sup>(1)</sup> These numbers indicate relubricatable type. If maintenance free type is needed, please order without suffix "D1".

<sup>(2)</sup> Adapter number with suffix "X" means a narrow slot type adapter sleeve.

In this case the lock washer with the straight inner prong should be used.

<sup>(3)</sup> If the inch series housing units with dust cover are ordered with a closed end, the suffixes E, S or A are not included.

Example: CM-UKFLX05D1;HE2305

Remarks Please refer to page A21 for size of grease fitting.

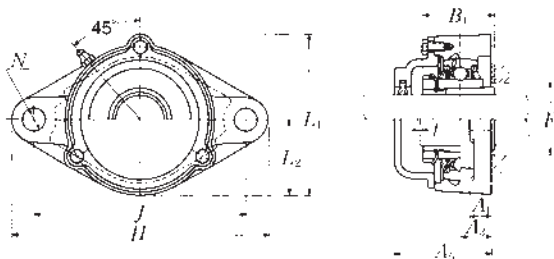

**Cast dust cover type**

Open end **C-UKFL...D1**

Closed end **CM-UKFL...D1**

Bolt size  mm inch	Bearing number	Housing number	Unit number (2) cast dust cover type	Nominal dimensions				Mass of unit	
				<i>t</i> max.	<i>A</i> <sub>5</sub>	<i>L</i> <sub>1</sub>	<i>L</i> <sub>2</sub>	UKF	C(CM)
M10 $\frac{3}{8}$	UKX05D1;H2305X	FLX05D1	C(CM)-UKFLX05D1;H2305X	2	56	86	41.5	1.0	1.2
	UKX05D1;HE2305	FLX05D1	C(CM)-UKFLX05ED1;HE2305	$\frac{5}{64}$	$2\frac{7}{32}$	$3\frac{3}{8}$	$1\frac{5}{8}$	2.2	2.7
M14 $\frac{1}{2}$	UKX06D1;H2306X	FLX06D1	C(CM)-UKFLX06D1;H2306X	2	59	98.5	47.5	1.4	1.6
	UKX06D1;HS2306	FLX06D1	C(CM)-UKFLX06SD1;HS2306	$\frac{5}{64}$	$2\frac{5}{16}$	$3\frac{7}{8}$	$1\frac{7}{8}$	3.1	3.5
M14 $\frac{1}{2}$	UKX07D1;H2307X	FLX07D1	C(CM)-UKFLX07D1;H2307X	3	66	108.5	52.5	1.8	2.2
	UKX07D1;HS2307	FLX07D1	C(CM)-UKFLX07SD1;HS2307	$\frac{1}{8}$	$2\frac{19}{32}$	$4\frac{9}{32}$	$2\frac{1}{16}$	4.0	4.9
M14 $\frac{1}{2}$	UKX08D1;H2308X	FLX08D1	C(CM)-UKFLX08D1;H2308X	3	70	114.5	55.5	2.2	2.6
	UKX08D1;HE2308X	FLX08D1	C(CM)-UKFLX08ED1;HE2308X	$\frac{1}{8}$	$2\frac{3}{4}$	$4\frac{1}{4}$	$2\frac{3}{16}$	4.9	5.7
M14 $\frac{1}{2}$	UKX09D1;H2309X	FLX09D1	C(CM)-UKFLX09D1;H2309X	3	73	119.5	58	2.2	2.7
	UKX09D1;HA2309	FLX09D1	C(CM)-UKFLX09AD1;HA2309	$\frac{1}{8}$	$2\frac{7}{8}$	$4\frac{23}{32}$	$2\frac{9}{32}$	4.9	6.0
M16 $\frac{5}{8}$	UKX10D1;H2310X	FLX10D1	C(CM)-UKFLX10D1;H2310X	3	76	133.5	66.5	3.1	3.6
	UKX10D1;HS2310	FLX10D1	C(CM)-UKFLX10SD1;HS2310	$\frac{1}{8}$	3	$5\frac{1}{4}$	$2\frac{5}{8}$	6.8	7.9
	UKX10D1;HA2310	FLX10D1	C(CM)-UKFLX10AD1;HA2310						
	UKX10D1;HE2310X	FLX10D1	C(CM)-UKFLX10ED1;HE2310X						

## Take-up unit, cast housing Adapter type

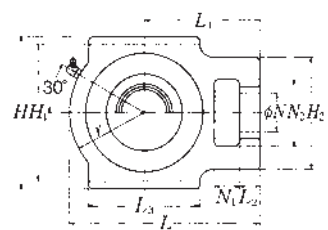
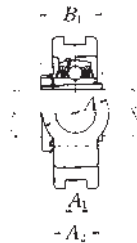
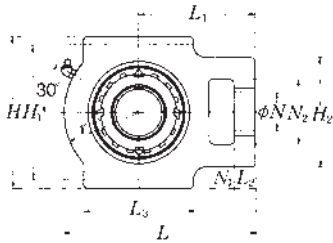

Pressed steel dust cover type  
Open end **Z-UKT...D1**  
Closed end **ZM-UKT...D1**

Shaft dia. mm inch	Unit number (1)(2)(3)	Nominal dimensions														Bearing number	
		mm inch															
		$N_1$	$L_2$	$H_2$	$N_2$	$N$	$L_3$	$A_1$	$H_1$	$H$	$L$	$A_2$	$A$	$r$	$L_1$	$B_1$	
20 3/4	UKT205D1;H2305X	16	12	51	32	19	51	12	76	89	97	24	32	35	62	35	UK205D1;H2305X
	UKT205D1;HE2305	5/8	15/32	2	1 1/4	3/4	2	0.472	2 23/64	3 1/2	3 19/16	1 15/16	1 1/4	1 3/8	2 7/16	1.378	UK205D1;HE2305
25 7/8 1	UKT206D1;H2306X	16	12	56	37	22	57	12	89	102	113	28	37	43	70	38	UK206D1;H2306X
	UKT206D1;HS2306	5/8	15/32	2 7/32	1 15/32	7/8	2 1/4	0.472	3 1/2	4 1/32	4 7/16	1 3/32	1 15/32	1 11/16	2 3/4	1.496	UK206D1;HS2306
	UKT206D1;HE2306X	5/8	15/32	2 7/32	1 15/32	7/8	2 1/4	0.472	3 1/2	4 1/32	4 7/16	1 3/32	1 15/32	1 11/16	2 3/4	1.496	UK206D1;HE2306X
30 1 1/8	UKT207D1;H2307X	16	15	64	37	22	64	12	89	102	129	30	37	51	78	43	UK207D1;H2307X
	UKT207D1;HS2307	5/8	19/32	2 17/32	1 15/32	7/8	2 17/32	0.472	3 1/2	4 1/32	5 3/32	1 3/16	1 15/32	2	3 1/16	1.693	UK207D1;HS2307
35 1 1/4 1 3/8	UKT208D1;H2308X	19	18	83	49	29	83	16	102	114	144	33	49	56	88	46	UK208D1;H2308X
	UKT208D1;HE2308X	3/4	23/32	3 9/32	1 15/16	1 5/32	3 9/32	0.630	4 1/64	4 1/2	5 21/32	1 5/16	1 15/16	2 7/32	3 15/32	1.811	UK208D1;HE2308X
	UKT208D1;HS2308X	3/4	23/32	3 9/32	1 15/16	1 5/32	3 9/32	0.630	4 1/64	4 1/2	5 21/32	1 5/16	1 15/16	2 7/32	3 15/32	1.811	UK208D1;HS2308X
40 1 7/16 1 1/2 1 5/8	UKT209D1;H2309X	19	18	83	49	29	83	16	102	117	145	35	49	57	88	50	UK209D1;H2309X
	UKT209D1;HA2309	3/4	23/32	3 9/32	1 15/16	1 5/32	3 9/32	0.630	4 1/64	4 19/32	5 23/32	1 3/8	1 15/16	2 1/4	3 15/32	1.969	UK209D1;HA2309
	UKT209D1;HE2309X	3/4	23/32	3 9/32	1 15/16	1 5/32	3 9/32	0.630	4 1/64	4 19/32	5 23/32	1 3/8	1 15/16	2 1/4	3 15/32	1.969	UK209D1;HE2309X
45 1 5/8 1 11/16 1 3/4	UKT210D1;H2310X	19	18	83	49	29	86	16	102	117	151	37	49	59	92	55	UK210D1;H2310X
	UKT210D1;HS2310	3/4	23/32	3 9/32	1 15/16	1 5/32	3 3/8	0.630	4 1/64	4 19/32	5 15/16	1 15/32	1 15/16	2 9/16	3 5/8	2.165	UK210D1;HS2310
	UKT210D1;HA2310	3/4	23/32	3 9/32	1 15/16	1 5/32	3 3/8	0.630	4 1/64	4 19/32	5 15/16	1 15/32	1 15/16	2 9/16	3 5/8	2.165	UK210D1;HA2310
	UKT210D1;HE2310X	3/4	23/32	3 9/32	1 15/16	1 5/32	3 3/8	0.630	4 1/64	4 19/32	5 15/16	1 15/32	1 15/16	2 9/16	3 5/8	2.165	UK210D1;HE2310X
50 1 7/8 1 15/16 2	UKT211D1;H2311X	25	21	102	64	35	95	22	130	146	171	38	64	65	106	59	UK211D1;H2311X
	UKT211D1;HS2311	3 1/32	13/16	4 1/32	2 17/32	1 3/8	3 3/4	0.866	5 1/8	5 3/4	6 23/32	1 1/2	2 17/32	2 9/16	4 3/16	2.323	UK211D1;HS2311
	UKT211D1;HA2311	3 1/32	13/16	4 1/32	2 17/32	1 3/8	3 3/4	0.866	5 1/8	5 3/4	6 23/32	1 1/2	2 17/32	2 9/16	4 3/16	2.323	UK211D1;HA2311
55 2 1/8	UKT211D1;HE2311XY																UK211D1;HE2311XY
	UKT212D1;H2312X	32	21	102	64	35	102	22	130	146	194	42	64	75	119	62	UK212D1;H2312X
UKT212D1;HS2312	1 1/4	13/16	4 1/32	2 17/32	1 3/8	4 1/32	0.866	5 1/8	5 3/4	7 5/8	1 23/32	2 17/32	2 15/16	4 11/16	2.441	UK212D1;HS2312	

Notes (1) These numbers indicate relubricatable type. If maintenance free type is needed, please order without suffix "D1".

(2) Adapter number with suffix "X" means a narrow slot type adapter sleeve.

In this case the lock washer with the straight inner prong should be used.

(3) For HE2311XY, screw thread pitch different from the standard is applied, because of the thin thread section of sleeve.

To distinguish it, a suffix "Y" is added.

Remarks Please refer to page A21 for size of grease fitting.

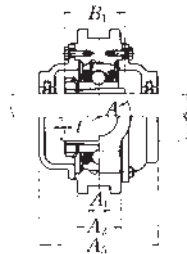
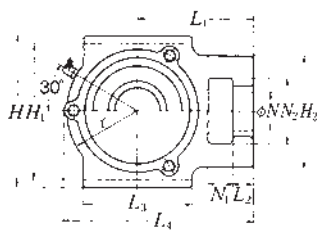

**Cast dust cover type**  
 Open end **C-UKT...D1**  
 Closed end **CM-UKT...D1**

Housing number	Unit number pressed steel dust cover type	Unit number cast dust cover type	Nominal dimensions				Mass of unit		
			<i>t</i> max.	<i>A</i> <sub>4</sub>	<i>L</i> <sub>4</sub>	<i>A</i> <sub>5</sub>	UKT	Z(ZM)	C(CM)
T205D1	Z(ZM)-UKT205D1;H2305X	C(CM)-UKT205D1;H2305X	2	48	100.5	70	0.9	0.9	1.2
T205D1	Z(ZM)-UKT205ED1;HE2305	C(CM)-UKT205ED1;HE2305	$\frac{5}{8}$	$1\frac{29}{32}$	$3\frac{31}{32}$	$2\frac{3}{4}$	2.0	2.0	2.6
T206D1	Z(ZM)-UKT206D1;H2306X	C(CM)-UKT206D1;H2306X	2	53	113.5	75	1.3	1.4	1.8
T206D1	Z(ZM)-UKT206SD1;HS2306	C(CM)-UKT206SD1;HS2306	$\frac{5}{64}$	$2\frac{3}{32}$	$4\frac{15}{32}$	$2\frac{15}{16}$	2.9	3.1	4.0
T206D1	Z(ZM)-UKT206ED1;HE2306X	C(CM)-UKT206ED1;HE2306X							
T207D1	Z(ZM)-UKT207D1;H2307X	C(CM)-UKT207D1;H2307X	3	60	129	80	1.7	1.8	2.2
T207D1	Z(ZM)-UKT207SD1;HS2307	C(CM)-UKT207SD1;HS2307	$\frac{1}{8}$	$2\frac{11}{32}$	$5\frac{3}{32}$	$3\frac{5}{32}$	3.7	4.0	4.9
T208D1	Z(ZM)-UKT208D1;H2308X	C(CM)-UKT208D1;H2308X	3	69	144	90	2.5	2.6	3.3
T208D1	Z(ZM)-UKT208ED1;HE2308X	C(CM)-UKT208ED1;HE2308X	$\frac{1}{8}$	$2\frac{23}{32}$	$5\frac{21}{32}$	$3\frac{17}{32}$	5.5	5.7	7.3
T208D1	Z(ZM)-UKT208SD1;HS2308X	C(CM)-UKT208SD1;HS2308X							
T209D1	Z(ZM)-UKT209D1;H2309X	C(CM)-UKT209D1;H2309X	3	69	145.5	95	2.5	2.6	3.5
T209D1	Z(ZM)-UKT209AD1;HA2309	C(CM)-UKT209AD1;HA2309							
T209D1	Z(ZM)-UKT209ED1;HE2309X	C(CM)-UKT209ED1;HE2309X	$\frac{1}{8}$	$2\frac{23}{32}$	$5\frac{23}{32}$	$3\frac{3}{4}$	5.5	5.7	7.7
T209D1	Z(ZM)-UKT209SD1;HS2309X	C(CM)-UKT209SD1;HS2309X							
T210D1	Z(ZM)-UKT210D1;H2310X	C(CM)-UKT210D1;H2310X	3	76	152	100	2.7	2.8	3.8
T210D1	Z(ZM)-UKT210SD1;HS2310	C(CM)-UKT210SD1;HS2310							
T210D1	Z(ZM)-UKT210AD1;HA2310	C(CM)-UKT210AD1;HA2310	$\frac{1}{8}$	3	$5\frac{31}{32}$	$3\frac{15}{16}$	6.0	6.2	8.4
T210D1	Z(ZM)-UKT210ED1;HE2310X	C(CM)-UKT210ED1;HE2310X							
T211D1	Z(ZM)-UKT211D1;H2311X	C(CM)-UKT211D1;H2311X	4	77	171.5	100	4.1	4.3	5.3
T211D1	Z(ZM)-UKT211SD1;HS2311	C(CM)-UKT211SD1;HS2311							
T211D1	Z(ZM)-UKT211AD1;HA2311	C(CM)-UKT211AD1;HA2311	$\frac{5}{32}$	$3\frac{3}{32}$	$6\frac{3}{4}$	$3\frac{15}{16}$	9.0	9.5	12
T211D1	Z(ZM)-UKT211ED1;HE2311XY	C(CM)-UKT211ED1;HE2311XY							
T212D1	Z(ZM)-UKT212D1;H2312X	C(CM)-UKT212D1;H2312X	4	89	194	115	4.9	5.2	6.3
T212D1	Z(ZM)-UKT212SD1;HS2312	C(CM)-UKT212SD1;HS2312	$\frac{5}{32}$	$3\frac{1}{2}$	$7\frac{5}{8}$	$4\frac{17}{32}$	11	11	14

## Take-up unit, cast housing Adapter type

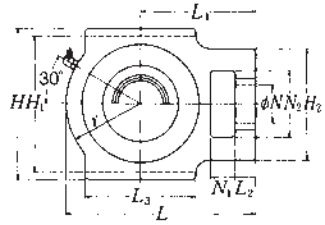
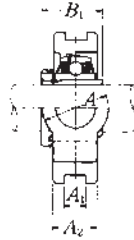
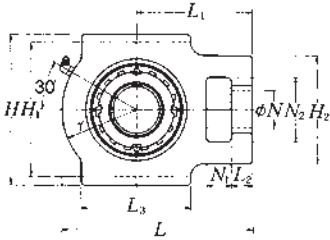

### Pressed steel dust cover type

Open end **Z-UKT...D1**

Closed end **ZM-UKT...D1**

Shaft dia.  mm inch	Unit number <sup>(1)</sup> ( <sup>2</sup> )	Nominal dimensions															Bearing number
		mm inch															
		$N_1$	$L_2$	$H_2$	$N_2$	$N$	$L_3$	$A_1$	$H_1$	$H$	$L$	$A_2$	$A$	$r$	$L_1$	$B_1$	
60 2 3/16 2 1/4 2 3/8	UKT213D1;H2313X UKT213D1;HA2313 UKT213D1;HE2313X UKT213D1;HS2313X	32	23	111	70	41	121	26	151	167	224	44	70	87	137	65	UK213D1;H2313X UK213D1;HA2313 UK213D1;HE2313X UK213D1;HS2313X
65 2 7/16 2 1/2	UKT215D1;H2315X UKT215D1;HA2315 UKT215D1;HE2315X	32	23	111	70	41	121	26	151	167	232	48	70	92	140	73	UK215D1;H2315X UK215D1;HA2315 UK215D1;HE2315X
70 2 11/16 2 3/4	UKT216D1;H2316X UKT216D1;HA2316 UKT216D1;HE2316X	32	23	111	70	41	121	26	165	184	235	51	70	95	140	78	UK216D1;H2316X UK216D1;HA2316 UK216D1;HE2316X
75 2 15/16 3	UKT217D1;H2317X UKT217D1;HA2317X UKT217D1;HE2317X	38	31	124	73	48	157	30	173	198	260	54	73	98	162	82	UK217D1;H2317X UK217D1;HA2317X UK217D1;HE2317X

Notes <sup>(1)</sup> These numbers indicate relubricatable type. If maintenance free type is needed, please order without suffix "D1".

<sup>(2)</sup> Adapter number with suffix "X" means a narrow slot type adapter sleeve.

In this case the lock washer with the straight inner prong should be used.

Remarks Please refer to page A21 for size of grease fitting.

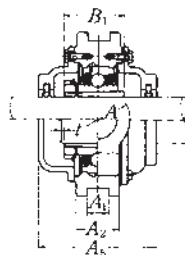
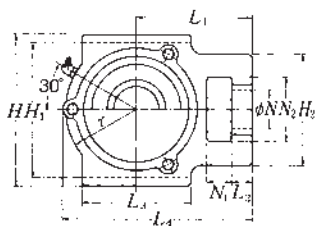
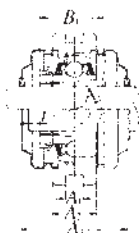

**Cast dust cover type**  
 Open end **C-UKT...D1**  
 Closed end **CM-UKT...D1**

Housing number	Unit number pressed steel dust cover type	Unit number cast dust cover type	Nominal dimensions				Mass of unit		
			mm inch				kg lb		
			$t$ max.	$A_4$	$L_4$	$A_5$	UKT	Z(ZM)	C(CM)
T213D1	Z(ZM)-UKT213D1;H2313X	C(CM)-UKT213D1;H2313X	4	91	224	120	7.1	7.4	8.8
T213D1	Z(ZM)-UKT213AD1;HA2313	C(CM)-UKT213AD1;HA2313							
T213D1	Z(ZM)-UKT213ED1;HE2313X	C(CM)-UKT213ED1;HE2313X	$\frac{5}{32}$	$3\frac{19}{32}$	$8\frac{9}{16}$	$4\frac{29}{32}$	16	16	19
T213D1	Z(ZM)-UKT213SD1;HS2313X	C(CM)-UKT213SD1;HS2313X							
T215D1	—	C(CM)-UKT215D1;H2315X	4	—	232	135	7.7	—	10
T215D1	—	C(CM)-UKT215AD1;HA2315							
T215D1	—	C(CM)-UKT215ED1;HE2315X	$\frac{5}{32}$	—	$9\frac{1}{8}$	$5\frac{5}{16}$	17	—	22
T216D1	—	C(CM)-UKT216D1;H2316X	4	—	235	145	8.7	—	12
T216D1	—	C(CM)-UKT216AD1;HA2316							
T216D1	—	C(CM)-UKT216ED1;HE2316X	$\frac{5}{32}$	—	$9\frac{1}{4}$	$5\frac{23}{32}$	19	—	26
T217D1	—	C(CM)-UKT217D1;H2317X	5	—	260	155	11	—	15
T217D1	—	C(CM)-UKT217AD1;HA2317X							
T217D1	—	C(CM)-UKT217ED1;HE2317X	$\frac{13}{64}$	—	$10\frac{1}{4}$	$6\frac{3}{32}$	24	—	33



## Take-up unit, cast housing Adapter type

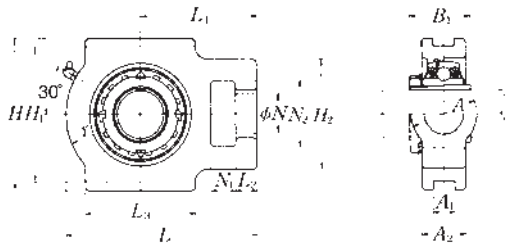

Shaft dia. mm inch	Unit number <sup>(1)</sup> ( <sup>2</sup> )( <sup>3</sup> )	Nominal dimensions														
		mm inch														
		N <sub>1</sub>	L <sub>2</sub>	H <sub>2</sub>	N <sub>2</sub>	N	L <sub>3</sub>	A <sub>1</sub>	H <sub>1</sub>	H	L	A <sub>2</sub>	A	r	L <sub>1</sub>	B <sub>1</sub>
20 3/4	UKT305D1;H2305X	16	14	62	36	26	65	12	80	89	122	26	36	46	76	35
	UKT305D1;HE2305	5/8	9/16	2 7/16	1 13/32	1 1/32	2 9/16	0.472	2 5/32	3 1/2	4 13/16	1 1/2	1 13/32	1 13/16	3	1.378
25 7/8 1	UKT306D1;H2306X	18	16	70	41	28	74	16	90	100	137	28	41	52	85	38
	UKT306D1;HS2306 UKT306D1;HE2306X	23/32	5/8	2 3/4	1 5/8	1 3/32	2 29/32	0.630	3 35/64	3 15/16	5 13/32	1 3/32	1 5/8	2 1/16	3 11/32	1.496
30 1 1/8	UKT307D1;H2307X	20	17	75	45	30	80	16	100	111	150	32	45	56	94	43
	UKT307D1;HS2307	25/32	21/32	2 15/16	1 25/32	1 1/16	3 5/32	0.630	3 15/16	4 3/8	5 29/32	1 1/4	1 25/32	2 7/32	3 11/16	1.693
35 1 1/4 1 3/8	UKT308D1;H2308X	22	19	83	50	32	89	18	112	124	162	34	50	62	100	46
	UKT308D1;HE2308X UKT308D1;HS2308X	7/8	3/4	3 3/32	1 31/32	1 1/4	3 1/2	0.709	4 13/32	4 7/8	6 3/8	1 11/32	1 31/32	2 7/16	3 15/16	1.811
40 1 7/16 1 1/2 1 5/8	UKT309D1;H2309X	24	20	90	55	34	97	18	125	138	178	38	55	68	110	50
	UKT309D1;HA2309	15/16	25/32	3 17/32	2 5/32	1 11/32	3 13/16	0.709	4 59/64	5 7/16	7	1 1/2	2 5/32	2 11/16	4 11/32	1.969
	UKT309D1;HE2309X UKT309D1;HS2309X															
45 1 5/8 1 11/16 1 3/4	UKT310D1;H2310X	27	22	98	61	37	106	20	140	151	192	40	61	74	118	55
	UKT310D1;HS2310	1 1/16	7/8	3 27/32	2 13/32	1 15/32	4 3/16	0.787	5 33/64	5 15/16	7 9/16	1 9/16	2 13/32	2 29/32	4 21/32	2.165
	UKT310D1;HA2310 UKT310D1;HE2310X															
50 1 7/8 1 15/16 2	UKT311D1;H2311X	29	23	105	66	39	115	22	150	163	207	44	66	80	127	59
	UKT311D1;HS2311	1 5/32	29/32	4 1/8	2 19/32	1 17/32	4 17/32	0.866	5 29/32	6 13/32	8 5/32	1 23/32	2 19/32	3 5/32	5	2.323
	UKT311D1;HA2311 UKT311D1;HE2311XY															
55 2 1/8	UKT312D1;H2312X	31	25	113	71	41	123	22	160	178	220	46	71	85	135	62
	UKT312D1;HS2312	1 1/32	31/32	4 7/16	2 25/32	1 5/8	4 27/32	0.866	6 19/64	7	8 21/32	1 13/16	2 25/32	3 11/32	5 5/16	2.441

Notes (1) These numbers indicate relubricatable type. If maintenance free type is needed, please order without suffix "D1".

(2) Adapter number with suffix "X" means a narrow slot type adapter sleeve.

In this case the lock washer with the straight inner prong should be used.

(3) For HE2311XY, screw thread pitch different from the standard is applied, because of the thin thread section of sleeve.

To distinguish it, a suffix "Y" is added.

Remarks Please refer to page A21 for size of grease fitting.

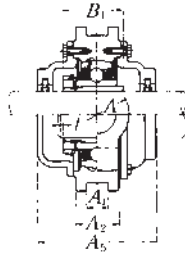
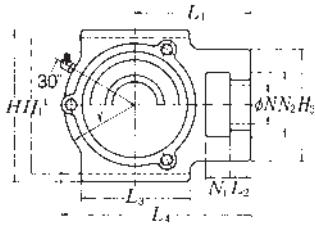

**Cast dust cover type**

Open end **C-UKT...D1**  
 Closed end **CM-UKT...D1**

Bearing number	Housing number	Unit number cast dust cover type	Nominal dimensions			Mass of unit	
			<i>t</i> max.	<i>L</i> <sub>4</sub>	<i>A</i> <sub>5</sub>	UKT	C(CM)
UK305D1;H2305X UK305D1;HE2305	T305D1 T305D1	<b>C(CM)-UKT305D1;H2305X</b> <b>C(CM)-UKT305ED1;HE2305</b>	2 <sup>5</sup> / <sub>64</sub>	122 4 <sup>13</sup> / <sub>16</sub>	80 3 <sup>5</sup> / <sub>32</sub>	1.4 3.1	1.9 4.2
UK306D1;H2306X UK306D1;HS2306 UK306D1;HE2306X	T306D1 T306D1 T306D1	<b>C(CM)-UKT306D1;H2306X</b> <b>C(CM)-UKT306SD1;HS2306</b> <b>C(CM)-UKT306ED1;HE2306X</b>	2 <sup>5</sup> / <sub>64</sub>	139 5 <sup>3</sup> / <sub>32</sub>	85 3 <sup>1</sup> / <sub>32</sub>	1.8 4.0	2.5 5.5
UK307D1;H2307X UK307D1;HS2307	T307D1 T307D1	<b>C(CM)-UKT307D1;H2307X</b> <b>C(CM)-UKT307SD1;HS2307</b>	3 <sup>1</sup> / <sub>8</sub>	152 5 <sup>3</sup> / <sub>32</sub>	95 3 <sup>3</sup> / <sub>4</sub>	2.4 5.3	3.3 7.3
UK308D1;H2308X UK308D1;HE2308X UK308D1;HS2308X	T308D1 T308D1 T308D1	<b>C(CM)-UKT308D1;H2308X</b> <b>C(CM)-UKT308ED1;HE2308X</b> <b>C(CM)-UKT308SD1;HS2308X</b>	3 <sup>1</sup> / <sub>8</sub>	164 6 <sup>15</sup> / <sub>32</sub>	105 4 <sup>1</sup> / <sub>8</sub>	3.0 6.6	4.3 9.5
UK309D1;H2309X UK309D1;HA2309 UK309D1;HE2309X UK309D1;HS2309X	T309D1 T309D1 T309D1 T309D1	<b>C(CM)-UKT309D1;H2309X</b> <b>C(CM)-UKT309AD1;HA2309</b> <b>C(CM)-UKT309ED1;HE2309X</b> <b>C(CM)-UKT309SD1;HS2309X</b>	3 <sup>1</sup> / <sub>8</sub>	181 7 <sup>7</sup> / <sub>8</sub>	110 4 <sup>1</sup> / <sub>32</sub>	4.0 8.8	5.6 12
UK310D1;H2310X UK310D1;HS2310 UK310D1;HA2310 UK310D1;HE2310X	T310D1 T310D1 T310D1 T310D1	<b>C(CM)-UKT310D1;H2310X</b> <b>C(CM)-UKT310SD1;HS2310</b> <b>C(CM)-UKT310AD1;HA2310</b> <b>C(CM)-UKT310ED1;HE2310X</b>	3 <sup>1</sup> / <sub>8</sub>	197 7 <sup>3</sup> / <sub>4</sub>	120 4 <sup>29</sup> / <sub>32</sub>	5.1 11	7.1 16
UK311D1;H2311X UK311D1;HS2311 UK311D1;HA2311 UK311D1;HE2311XY	T311D1 T311D1 T311D1 T311D1	<b>C(CM)-UKT311D1;H2311X</b> <b>C(CM)-UKT311SD1;HS2311</b> <b>C(CM)-UKT311AD1;HA2311</b> <b>C(CM)-UKT311ED1;HE2311XY</b>	4 <sup>5</sup> / <sub>32</sub>	211 8 <sup>5</sup> / <sub>16</sub>	125 4 <sup>29</sup> / <sub>32</sub>	6.3 14	8.6 19
UK312D1;H2312X UK312D1;HS2312	T312D1 T312D1	<b>C(CM)-UKT312D1;H2312X</b> <b>C(CM)-UKT312SD1;HS2312</b>	4 <sup>5</sup> / <sub>32</sub>	227 8 <sup>15</sup> / <sub>16</sub>	135 5 <sup>5</sup> / <sub>16</sub>	7.6 17	10 22

## Take-up unit, cast housing Adapter type

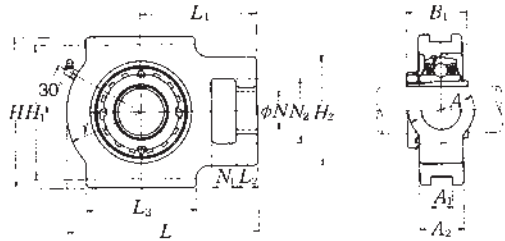

Shaft dia.  mm inch	Unit number <sup>(1)(2)</sup>	Nominal dimensions														
		mm inch														
		N <sub>1</sub>	L <sub>2</sub>	H <sub>2</sub>	N <sub>2</sub>	N	L <sub>3</sub>	A <sub>1</sub>	H <sub>1</sub>	H	L	A <sub>2</sub>	A	r	L <sub>1</sub>	B <sub>1</sub>
60 2 3/16 2 1/4 2 3/8	UKT313D1;H2313X UKT313D1;HA2313 UKT313D1;HE2313X UKT313D1;HS2313X	32	27	116	70	43	134	26	170	190	238	50	80	92	146	65
		1 1/4	1 1/16	4 3/16	2 3/4	1 11/16	5 3/32	1.024	6 11/16	7 15/32	9 3/8	1 31/32	3 5/32	3 3/8	5 3/4	2.559
65 2 7/16 2 1/2	UKT315D1;H2315X UKT315D1;HA2315 UKT315D1;HE2315X	36	27	132	85	46	150	26	192	216	262	55	90	102	160	73
		1 13/32	1 1/16	5 3/16	3 11/32	1 13/16	5 29/32	1.024	7 9/16	8 1/2	10 5/16	2 5/32	3 17/32	4 1/32	6 5/16	2.874
70 2 11/16 2 3/4	UKT316D1;H2316X UKT316D1;HA2316 UKT316D1;HE2316X	42	30	150	98	53	160	30	204	230	282	60	102	108	174	78
		1 21/32	1 3/16	5 29/32	3 27/32	2 3/32	6 5/16	1.181	8 1/32	9 1/16	11 3/32	2 3/8	4 1/32	4 1/4	6 27/32	3.071
75 2 5/8 3	UKT317D1;H2317X UKT317D1;HA2317X UKT317D1;HE2317X	42	32	152	98	53	170	32	214	240	298	64	102	115	183	82
		1 21/32	1 1/4	5 31/32	3 27/32	2 3/32	6 11/16	1.260	8 27/64	9 7/16	11 29/32	2 17/32	4 1/32	4 17/32	7 7/32	3.228
80 3 3/16	UKT318D1;H2318X UKT318D1;HA2318X	46	32	160	106	57	175	32	228	255	312	66	110	120	192	86
		1 13/16	1 1/4	6 5/16	4 3/16	2 1/4	6 7/8	1.260	8 31/32	10 1/32	12 3/32	2 19/32	4 11/32	4 23/32	7 9/16	3.386
85 3 1/4	UKT319D1;H2319X UKT319D1;HE2319X	46	33	165	106	57	180	35	240	270	322	72	110	125	197	90
		1 13/16	1 5/16	6 1/2	4 3/16	2 1/4	7 3/32	1.378	9 29/64	10 5/8	12 11/16	2 27/32	4 11/32	4 29/32	7 3/4	3.543
90 3 7/16 3 1/2	UKT320D1;H2320X UKT320D1;HA2320 UKT320D1;HE2320X	48	34	175	115	59	200	35	260	290	345	75	120	135	210	97
		1 7/8	1 1/32	6 7/8	4 17/32	2 5/16	7 7/8	1.378	10 15/64	11 1/32	13 19/32	2 15/16	4 29/32	5 5/16	8 9/32	3.819
100	UKT322D1;H2322X	52	40	185	125	65	215	38	285	320	385	80	130	150	235	105
110	UKT324D1;H2324	60	44	210	140	70	230	45	320	355	432	90	140	165	267	112
115	UKT326D1;H2326	65	47	220	150	75	240	50	350	385	465	100	150	180	285	121
125	UKT328D1;H2328	70	52	230	160	80	255	50	380	415	515	100	155	200	315	131

Notes (1) These numbers indicate relubricatable type. If maintenance free type is needed, please order without suffix "D1".

(2) Adapter number with suffix "X" means a narrow slot type adapter sleeve.

In this case the lock washer with the straight inner prong should be used.

Remarks Please refer to page A21 for size of grease fitting.

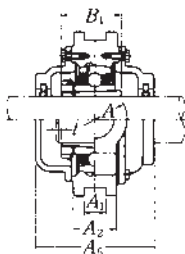
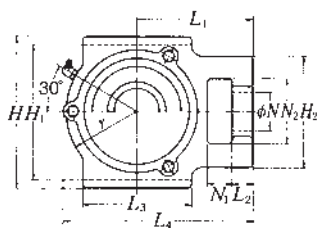

**Cast dust cover type**

Open end **C-UKT...D1**  
 Closed end **CM-UKT...D1**

Bearing number	Housing number	Unit number cast dust cover type	Nominal dimensions			Mass of unit	
			<i>t</i> max.	<i>L</i> <sub>4</sub>	<i>A</i> <sub>5</sub>	UKT	C(CM)
UK313D1;H2313X	T313D1	<b>C(CM)-UKT313D1;H2313X</b>	4	244	140	9.2	12
UK313D1;HA2313	T313D1	<b>C(CM)-UKT313AD1;HA2313</b>	5/32	9 9/32	5 1/2	20	26
UK313D1;HE2313X	T313D1	<b>C(CM)-UKT313ED1;HE2313X</b>					
UK313D1;HS2313X	T313D1	<b>C(CM)-UKT313SD1;HS2313X</b>					
UK315D1;H2315X	T315D1	<b>C(CM)-UKT315D1;H2315X</b>	4	268	150	13	17
UK315D1;HA2315	T315D1	<b>C(CM)-UKT315AD1;HA2315</b>	5/32	10 9/16	5 29/32	29	37
UK315D1;HE2315X	T315D1	<b>C(CM)-UKT315ED1;HE2315X</b>					
UK316D1;H2316X	T316D1	<b>C(CM)-UKT316D1;H2316X</b>	4	287	155	16	21
UK316D1;HA2316	T316D1	<b>C(CM)-UKT316AD1;HA2316</b>	5/32	11 5/16	6 3/32	35	46
UK316D1;HE2316X	T316D1	<b>C(CM)-UKT316ED1;HE2316X</b>					
UK317D1;H2317X	T317D1	<b>C(CM)-UKT317D1;H2317X</b>	5	303	170	19	25
UK317D1;HA2317X	T317D1	<b>C(CM)-UKT317AD1;HA2317X</b>	13/64	11 15/16	6 1/16	42	55
UK317D1;HE2317X	T317D1	<b>C(CM)-UKT317ED1;HE2317X</b>					
UK318D1;H2318X	T318D1	<b>C(CM)-UKT318D1;H2318X</b>	5	317	170	21	28
UK318D1;HA2318X	T318D1	<b>C(CM)-UKT318AD1;HA2318X</b>	13/64	12 15/32	6 1/16	46	62
UK319D1;H2319X	T319D1	<b>C(CM)-UKT319D1;H2319X</b>	5	327	180	25	32
UK319D1;HE2319X	T319D1	<b>C(CM)-UKT319ED1;HE2319X</b>	13/64	12 7/8	7 3/32	55	71
UK320D1;H2320X	T320D1	<b>C(CM)-UKT320D1;H2320X</b>	5	350	190	30	39
UK320D1;HA2320	T320D1	<b>C(CM)-UKT320AD1;HA2320</b>	13/64	13 25/32	7 15/32	66	86
UK320D1;HE2320X	T320D1	<b>C(CM)-UKT320ED1;HE2320X</b>					
UK322D1;H2322X	T322D1	<b>C(CM)-UKT322D1;H2322X</b>	5	395	200	40	51
UK324D1;H2324	T324D1	<b>C(CM)-UKT324D1;H2324</b>	5	439	215	43	69
UK326D1;H2326	T326D1	<b>C(CM)-UKT326D1;H2326</b>	6	476	225	69	85
UK328D1;H2328	T328D1	<b>C(CM)-UKT328D1;H2328</b>	6	519	235	88	107

## Take-up unit, cast housing Adapter type

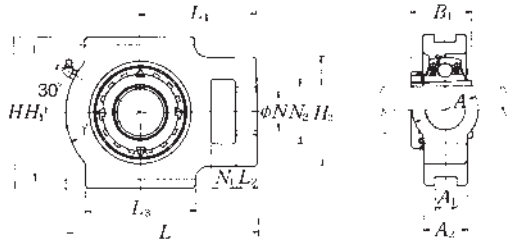

Shaft dia. mm inch	Unit number <sup>(1)</sup> <sup>(2)</sup> <sup>(3)</sup>	Nominal dimensions														
		mm inch														
		N <sub>1</sub>	L <sub>2</sub>	H <sub>2</sub>	N <sub>2</sub>	N	L <sub>3</sub>	A <sub>1</sub>	H <sub>1</sub>	H	L	A <sub>2</sub>	A	r	L <sub>1</sub>	B <sub>1</sub>
20 3/4	UKTX05D1;H2305X	16	12	56	37	22	57	12	89	102	113	28	37	43	70	35
	UKTX05D1;HE2305	5/8	15/32	2 7/32	1 15/32	7/8	2 1/4	0.472	3 1/2	4 1/2	4 7/16	1 3/32	1 15/32	1 11/16	2 3/4	1.378
25 7/8 1	UKTX06D1;H2306X	16	15	64	37	22	64	12	89	102	129	30	37	51	78	38
	UKTX06D1;HS2306 UKTX06D1;HE2306X	5/8	19/32	2 17/32	1 15/32	7/8	2 17/32	0.472	3 1/2	4 1/2	5 3/32	1 3/16	1 15/32	2	3 1/16	1.496
30 1 1/8	UKTX07D1;H2307X	19	17	83	49	29	83	16	102	114	144	36	49	56	88	43
	UKTX07D1;HS2307	3/4	21/32	3 3/32	1 15/16	1 5/32	3 3/32	0.630	4 1/4	4 1/2	5 21/32	1 13/32	1 15/16	2 7/32	3 15/32	1.693
35 1 1/4 1 3/8	UKTX08D1;H2308X	19	17	83	49	29	83	16	102	117	144	36	49	57	87	46
	UKTX08D1;HE2308X UKTX08D1;HS2308X	3/4	21/32	3 3/32	1 15/16	1 5/32	3 3/32	0.630	4 1/4	4 19/32	5 21/32	1 13/32	1 15/16	2 1/4	3 7/16	1.811
40 1 7/16 1 1/2 1 5/8	UKTX09D1;H2309X	19	18	83	49	29	86	16	102	117	151	38	49	59	92	50
	UKTX09D1;HA2309	3/4	23/32	3 3/32	1 15/16	1 5/32	3 3/8	0.630	4 1/4	4 19/32	5 15/16	1 1/2	1 15/16	2 5/16	3 5/8	1.969
	UKTX09D1;HE2309X UKTX09D1;HS2309X	3/4	23/32	3 3/32	1 15/16	1 5/32	3 3/8	0.630	4 1/4	4 19/32	5 15/16	1 1/2	1 15/16	2 5/16	3 5/8	1.969
45 1 5/8 1 11/16 1 3/4	UKTX10D1;H2310X	25	21	102	64	35	95	22	130	146	171	42	64	65	106	55
	UKTX10D1;HS2310	3 1/32	13/16	4 1/32	2 17/32	1 3/8	3 3/4	0.866	5 1/8	5 3/4	6 23/32	1 21/32	2 17/32	2 9/16	4 3/16	2.165
	UKTX10D1;HA2310 UKTX10D1;HE2310X	3 1/32	13/16	4 1/32	2 17/32	1 3/8	3 3/4	0.866	5 1/8	5 3/4	6 23/32	1 21/32	2 17/32	2 9/16	4 3/16	2.165
50 1 7/8 1 15/16 2	UKTX11D1;H2311X	32	21	102	64	35	102	22	130	146	194	44	64	75	119	59
	UKTX11D1;HS2311	1 1/4	13/16	4 1/32	2 17/32	1 3/8	4 1/32	0.866	5 1/8	5 3/4	7 5/8	1 23/32	2 17/32	2 15/16	4 11/16	2.323
	UKTX11D1;HA2311 UKTX11D1;HE2311XY	1 1/4	13/16	4 1/32	2 17/32	1 3/8	4 1/32	0.866	5 1/8	5 3/4	7 5/8	1 23/32	2 17/32	2 15/16	4 11/16	2.323
55 2 1/8	UKTX12D1;H2312X	32	23	111	70	41	121	26	151	167	224	48	70	87	137	62
	UKTX12D1;HS2312	1 1/4	29/32	4 3/8	2 3/4	1 5/8	4 3/4	1.024	5 15/16	6 9/16	8 13/16	1 7/8	2 3/4	3 7/16	5 13/32	2.441

Notes <sup>(1)</sup> These numbers indicate relubricatable type. If maintenance free type is needed, please order without suffix "D1".

<sup>(2)</sup> Adapter number with suffix "X" means a narrow slot type adapter sleeve.

In this case the lock washer with the straight inner prong should be used.

<sup>(3)</sup> For HE2311XY, screw thread pitch different from the standard is applied, because of the thin thread section of sleeve.

To distinguish it, a suffix "Y" is added.

Remarks Please refer to page A21 for size of grease fitting.

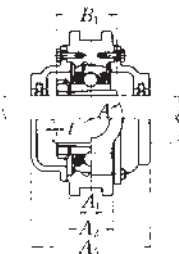
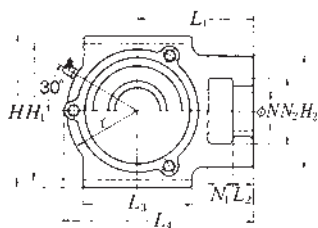

**Cast dust cover type**  
 Open end **C-UKT...D1**  
 Closed end **CM-UKT...D1**

Bearing number	Housing number	Unit number cast dust cover type	Nominal dimensions			Mass of unit	
			<i>t</i> max.	<i>L</i> <sub>4</sub>	<i>A</i> <sub>3</sub>	UKT	C(CM)
UKX05D1;H2305X UKX05D1;HE2305	TX05D1 TX05D1	<b>C(CM)-UKTX05D1;H2305X</b> <b>C(CM)-UKTX05ED1;HE2305</b>	2 <sup>5</sup> / <sub>64</sub>	113.5 4 <sup>15</sup> / <sub>32</sub>	75 2 <sup>15</sup> / <sub>16</sub>	1.3 2.9	1.8 4.0
UKX06D1;H2306X UKX06D1;HS2306 UKX06D1;HE2306X	TX06D1 TX06D1 TX06D1	<b>C(CM)-UKTX06D1;H2306X</b> <b>C(CM)-UKTX06SD1;HS2306</b> <b>C(CM)-UKTX06ED1;HE2306X</b>	2 <sup>5</sup> / <sub>64</sub>	129 5 <sup>3</sup> / <sub>32</sub>	80 3 <sup>5</sup> / <sub>32</sub>	1.7 3.7	2.2 4.9
UKX07D1;H2307X UKX07D1;HS2307	TX07D1 TX07D1	<b>C(CM)-UKTX07D1;H2307X</b> <b>C(CM)-UKTX07SD1;HS2307</b>	3 <sup>1</sup> / <sub>8</sub>	144 5 <sup>21</sup> / <sub>32</sub>	90 3 <sup>17</sup> / <sub>32</sub>	2.7 6.0	3.5 7.7
UKX08D1;H2308X UKX08D1;HE2308X UKX08D1;HS2308X	TX08D1 TX08D1 TX08D1	<b>C(CM)-UKTX08D1;H2308X</b> <b>C(CM)-UKTX08ED1;HE2308X</b> <b>C(CM)-UKTX08SD1;HS2308X</b>	3 <sup>1</sup> / <sub>8</sub>	144.5 5 <sup>11</sup> / <sub>16</sub>	95 3 <sup>3</sup> / <sub>4</sub>	2.8 6.2	3.7 8.2
UKX09D1;H2309X UKX09D1;HA2309 UKX09D1;HE2309X UKX09D1;HS2309X	TX09D1 TX09D1 TX09D1 TX09D1	<b>C(CM)-UKTX09D1;H2309X</b> <b>C(CM)-UKTX09AD1;HA2309</b> <b>C(CM)-UKTX09ED1;HE2309X</b> <b>C(CM)-UKTX09SD1;HS2309X</b>	3 <sup>1</sup> / <sub>8</sub>	152 5 <sup>31</sup> / <sub>32</sub>	100 3 <sup>15</sup> / <sub>16</sub>	2.7 6.0	3.8 8.4
UKX10D1;H2310X UKX10D1;HS2310 UKX10D1;HA2310 UKX10D1;HE2310X	TX10D1 TX10D1 TX10D1 TX10D1	<b>C(CM)-UKTX10D1;H2310X</b> <b>C(CM)-UKTX10SD1;HS2310</b> <b>C(CM)-UKTX10AD1;HA2310</b> <b>C(CM)-UKTX10ED1;HE2310X</b>	3 <sup>1</sup> / <sub>8</sub>	171.5 6 <sup>3</sup> / <sub>4</sub>	100 3 <sup>15</sup> / <sub>16</sub>	4.3 9.5	5.5 12
UKX11D1;H2311X UKX11D1;HS2311 UKX11D1;HA2311 UKX11D1;HE2311XY	TX11D1 TX11D1 TX11D1 TX11D1	<b>C(CM)-UKTX11D1;H2311X</b> <b>C(CM)-UKTX11SD1;HS2311</b> <b>C(CM)-UKTX11AD1;HA2311</b> <b>C(CM)-UKTX11ED1;HE2311XY</b>	4 <sup>5</sup> / <sub>32</sub>	194 7 <sup>5</sup> / <sub>8</sub>	115 4 <sup>17</sup> / <sub>32</sub>	5.1 11	6.6 15
UKX12D1;H2312X UKX12D1;HS2312	TX12D1 TX12D1	<b>C(CM)-UKTX12D1;H2312X</b> <b>C(CM)-UKTX12SD1;HS2312</b>	4 <sup>5</sup> / <sub>32</sub>	224 8 <sup>13</sup> / <sub>16</sub>	120 4 <sup>23</sup> / <sub>32</sub>	7.2 16	9.0 20

## Take-up unit, cast housing Adapter type

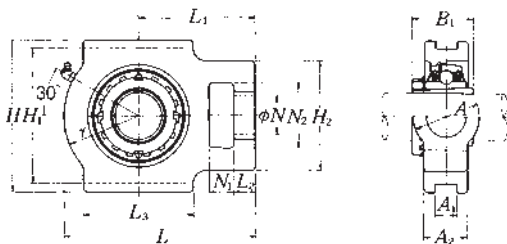

Shaft dia.  mm inch	Unit number <sup>(1)</sup> / <sub>(2)</sub>	Nominal dimensions														
		mm inch														
		$N_1$	$L_2$	$H_2$	$N_2$	$N$	$L_3$	$A_1$	$H_1$	$H$	$L$	$A_2$	$A$	$r$	$L_1$	$B_1$
60 2 3/16 2 1/4 2 3/8	UKTX13D1;H2313X UKTX13D1;HA2313 UKTX13D1;HE2313X UKTX13D1;HS2313X	32	23	111	70	41	121	26	151	167	224	48	70	87	137	65
		1 1/4	29/32	4 3/8	2 3/4	1 5/8	4 3/4	1.024	5 15/16	6 9/16	8 13/16	1 1/8	2 3/4	3 7/16	5 19/32	2.559
65 2 7/16 2 1/2	UKTX15D1;H2315X UKTX15D1;HA2315 UKTX15D1;HE2315X	32	23	111	70	41	121	28	165	184	235	48	70	95	140	73
		1 1/4	29/32	4 3/8	2 3/4	1 5/8	4 3/4	1.102	6 1/2	7 1/4	9 1/4	1 1/8	2 3/4	3 3/4	5 1/2	2.874
70 2 11/16 2 3/4	UKTX16D1;H2316X UKTX16D1;HA2316 UKTX16D1;HE2316X	38	30	124	73	48	157	28	173	198	260	54	73	98	162	78
		1 1/2	1 3/16	4 7/8	2 7/8	1 7/8	6 3/16	1.102	6 13/16	7 25/32	10 1/4	2 1/8	2 7/8	3 27/32	6 3/8	3.071
75 2 15/16 3	UKTX17D1;H2317X UKTX17D1;HA2317X UKTX17D1;HE2317X	38	30	124	73	48	157	28	173	198	260	54	73	98	162	82
		1 1/2	1 3/16	4 7/8	2 7/8	1 7/8	6 3/16	1.102	6 13/16	7 25/32	10 1/4	2 1/8	2 7/8	3 27/32	6 3/8	3.228

Notes <sup>(1)</sup> These numbers indicate relubricatable type. If maintenance free type is needed, please order without suffix "D1".

<sup>(2)</sup> Adapter number with suffix "X" means a narrow slot type adapter sleeve.

In this case the lock washer with the straight inner prong should be used.

Remarks Please refer to page A21 for size of grease fitting.

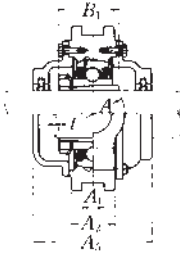
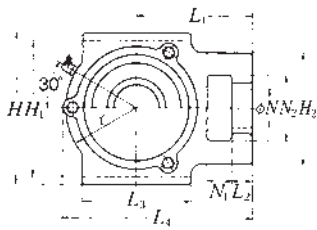

**Cast dust cover type**  
 Open end **C-UKT...D1**  
 Closed end **CM-UKT...D1**

Bearing number	Housing number	Unit number cast dust cover type	Nominal dimensions			Mass of unit	
			mm inch			kg lb	
			<i>t</i> max.	<i>L</i> <sub>4</sub>	<i>A</i> <sub>5</sub>	UKT	C(CM)
UKX13D1;H2313X UKX13D1;HA2313 UKX13D1;HE2313X UKX13D1;HS2313X	TX13D1 TX13D1 TX13D1 TX13D1	<b>C(CM)-UKTX13D1;H2313X</b> <b>C(CM)-UKTX13AD1;HA2313</b> <b>C(CM)-UKTX13ED1;HE2313X</b> <b>C(CM)-UKTX13SD1;HS2313X</b>	4   5/32	224  8 15/16	135  5 5/16	7.2 16	9.5 21
UKX15D1;H2315X UKX15D1;HA2315 UKX15D1;HE2315X	TX15D1 TX15D1 TX15D1	<b>C(CM)-UKTX15D1;H2315X</b> <b>C(CM)-UKTX15AD1;HA2315</b> <b>C(CM)-UKTX15ED1;HE2315X</b>	4  5/32	235 9 1/4	145 5 23/32	8.5 19	11 24
UKX16D1;H2316X UKX16D1;HA2316 UKX16D1;HE2316X	TX16D1 TX16D1 TX16D1	<b>C(CM)-UKTX16D1;H2316X</b> <b>C(CM)-UKTX16AD1;HA2316</b> <b>C(CM)-UKTX16ED1;HE2316X</b>	4  5/32	260 10 1/4	155 6 3/32	11 24	14 31
UKX17D1;H2317X UKX17D1;HA2317X UKX17D1;HE2317X	TX17D1 TX17D1 TX17D1	<b>C(CM)-UKTX17D1;H2317X</b> <b>C(CM)-UKTX17AD1;HA2317X</b> <b>C(CM)-UKTX17ED1;HE2317X</b>	5  13/64	262 10 5/16	165 6 1/2	11 24	15 33



## Cartridge unit, cast housing Adapter type

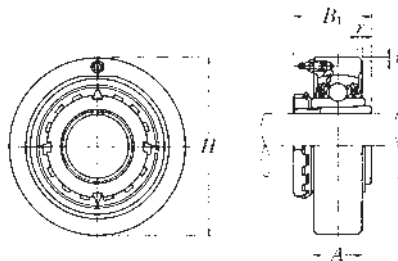

Shaft dia.  mm inch	Unit number <sup>(1)</sup> / <sub>(2)</sub> / <sub>(3)</sub>	Nominal dimensions				Bearing number	Housing number	Mass of unit  kg lb
		mm inch						
		H	A	r	B <sub>1</sub>			
20  3/4	UKC205D1;H2305X	80	22	2	35	UK205D1;H2305X	C205D1	0.7
	UKC205D1;HE2305	3.1496	55/64	0.079	1.378	UK205D1;HE2305	C205D1	1.5
25  7/8 1	UKC206D1;H2306X	85	27	2	38	UK206D1;H2306X	C206D1	0.9
	UKC206D1;HS2306 UKC206D1;HE2306X	3.3465	1 1/16	0.079	1.496	UK206D1;HS2306 UK206D1;HE2306X	C206D1 C206D1	2.0
30  1 1/8	UKC207D1;H2307X	90	28	2	43	UK207D1;H2307X	C207D1	1.0
	UKC207D1;HS2307	3.5433	1 1/64	0.079	1.693	UK207D1;HS2307	C207D1	2.2
35  1 1/4 1 3/8	UKC208D1;H2308X	100	30	2.5	46	UK208D1;H2308X	C208D1	1.3
	UKC208D1;HE2308X UKC208D1;HS2308X	3.9370	1 3/16	0.098	1.811	UK208D1;HE2308X UK208D1;HS2308X	C208D1 C208D1	2.9
40  1 7/16 1 1/2 1 5/8	UKC209D1;H2309X	110	31	2.5	50	UK209D1;H2309X	C209D1	1.6
	UKC209D1;HA2309 UKC209D1;HE2309X UKC209D1;HS2309X	4.3307	1 7/32	0.098	1.969	UK209D1;HA2309 UK209D1;HE2309X UK209D1;HS2309X	C209D1 C209D1 C209D1	3.5
45  1 5/8 1 11/16 1 3/4	UKC210D1;H2310X	120	33	2.5	55	UK210D1;H2310X	C210D1	2.1
	UKC210D1;HS2310 UKC210D1;HA2310 UKC210D1;HE2310X	4.7244	1 9/64	0.098	2.165	UK210D1;HS2310 UK210D1;HA2310 UK210D1;HE2310X	C210D1 C210D1 C210D1	4.6
50  1 7/8 1 15/16 2	UKC211D1;H2311X	125	35	2.5	59	UK211D1;H2311X	C211D1	2.3
	UKC211D1;HS2311 UKC211D1;HA2311 UKC211D1;HE2311XY	4.9213	1 3/8	0.098	2.323	UK211D1;HS2311 UK211D1;HA2311 UK211D1;HE2311XY	C211D1 C211D1 C211D1	5.1
55  2 1/8	UKC212D1;H2312X	130	38	2.5	62	UK212D1;H2312X	C212D1	2.6
	UKC212D1;HS2312	5.1181	1 1/2	0.098	2.441	UK212D1;HS2312	C212D1	5.7
60  2 3/16 2 1/4 2 3/8	UKC213D1;H2313X	140	40	3	65	UK213D1;H2313X	C213D1	3.2
	UKC213D1;HA2313 UKC213D1;HE2313X UKC213D1;HS2313X	5.5118	1 97/64	0.118	2.559	UK213D1;HA2313 UK213D1;HE2313X UK213D1;HS2313X	C213D1 C213D1 C213D1	7.1

Notes <sup>(1)</sup> These numbers indicate relubricatable type. If maintenance free type is needed, please order without suffix "D1".

<sup>(2)</sup> Adapter number with suffix "X" means a narrow slot type adapter sleeve.

In this case the lock washer with the straight inner prong should be used.

<sup>(3)</sup> For HE2311XY, screw thread pitch different from the standard is applied, because of the thin thread section of sleeve.

To distinguish it, a suffix "Y" is added.

Remarks Please refer to page A21 for size of grease fitting.



## Cartridge unit, cast housing Adapter type

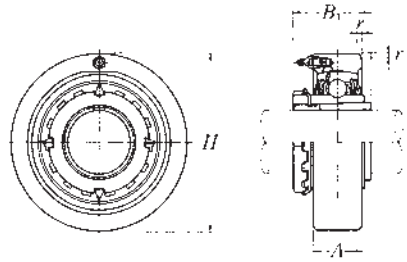

Shaft dia.  mm inch	Unit number <sup>(1)</sup> / <sub>(2)</sub> / <sub>(3)</sub>	Nominal dimensions				Bearing number	Housing number	Mass of unit  kg lb
		mm inch						
		H	A	r	B <sub>1</sub>			
20  3/4	UKC305D1;H2305X	90	26	2.5	35	UK305D1;H2305X	C305D1	1.0
	UKC305D1;HE2305	3.5433	1 1/32	0.098	1.378	UK305D1;HE2305	C305D1	2.2
25  7/8 1	UKC306D1;H2306X	100	28	2.5	38	UK306D1;H2306X	C306D1	1.3
	UKC306D1;HS2306 UKC306D1;HE2306X	3.9370	1 7/64	0.098	1.496	UK306D1;HS2306 UK306D1;HE2306X	C306D1 C306D1	2.9
30  1 1/8	UKC307D1;H2307X	110	32	3	43	UK307D1;H2307X	C307D1	1.8
	UKC307D1;HS2307	4.3307	1 1/64	0.118	1.693	UK307D1;HS2307	C307D1	4.0
35  1 1/4 1 3/8	UKC308D1;H2308X	120	34	3	46	UK308D1;H2308X	C308D1	2.2
	UKC308D1;HE2308X UKC308D1;HS2308X	4.7244	1 1/32	0.118	1.811	UK308D1;HE2308X UK308D1;HS2308X	C308D1 C308D1	4.9
40  1 7/16 1 1/2 1 5/8	UKC309D1;H2309X	130	38	3.5	50	UK309D1;H2309X	C309D1	2.7
	UKC309D1;HA2309 UKC309D1;HE2309X UKC309D1;HS2309X	5.1181	1 1/2	0.138	1.969	UK309D1;HA2309 UK309D1;HE2309X UK309D1;HS2309X	C309D1 C309D1 C309D1	6.0
45  1 5/8 1 11/16 1 3/4	UKC310D1;H2310X	140	40	3.5	55	UK310D1;H2310X	C310D1	3.4
	UKC310D1;HS2310 UKC310D1;HA2310 UKC310D1;HE2310X	5.5118	1 37/64	0.138	2.165	UK310D1;HS2310 UK310D1;HA2310 UK310D1;HE2310X	C310D1 C310D1 C310D1	7.5
50  1 7/8 1 15/16 2	UKC311D1;H2311X	150	44	3.5	59	UK311D1;H2311X	C311D1	4.0
	UKC311D1;HS2311 UKC311D1;HA2311 UKC311D1;HE2311XY	5.9055	1 47/64	0.138	2.323	UK311D1;HS2311 UK311D1;HA2311 UK311D1;HE2311XY	C311D1 C311D1 C311D1	8.8
55  2 1/8	UKC312D1;H2312X	160	46	3.5	62	UK312D1;H2312X	C312D1	4.8
	UKC312D1;HS2312	6.2992	1 13/16	0.138	2.441	UK312D1;HS2312	C312D1	11
60  2 3/16 2 1/4 2 3/8	UKC313D1;H2313X	170	50	3.5	65	UK313D1;H2313X	C313D1	5.6
	UKC313D1;HA2313 UKC313D1;HE2313X UKC313D1;HS2313X	6.6929	1 31/32	0.138	2.559	UK313D1;HA2313 UK313D1;HE2313X UK313D1;HS2313X	C313D1 C313D1 C313D1	12

Notes <sup>(1)</sup> These numbers indicate relubricatable type. If maintenance free type is needed, please order without suffix "D1".

<sup>(2)</sup> Adapter number with suffix "X" means a narrow slot type adapter sleeve.

In this case the lock washer with the straight inner prong should be used.

<sup>(3)</sup> For HE2311XY, screw thread pitch different from the standard is applied, because of the thin thread section of sleeve.

To distinguish it, a suffix "Y" is added.

Remarks Please refer to page A21 for size of grease fitting.

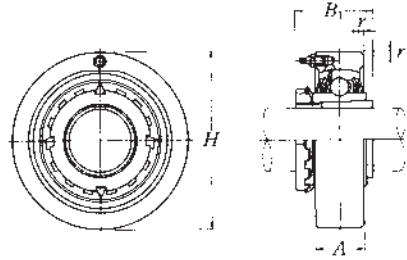

Shaft dia. mm inch	Unit number <sup>(1)</sup> / <sub>(2)</sub>	Nominal dimensions				Bearing number	Housing number	Mass of unit kg lb
		mm inch						
		H	A	r	B <sub>1</sub>			
65 2 7/16 2 1/2	UKC315D1;H2315X	190	55	4	73	UK315D1;H2315X	C315D1	7.9
	UKC315D1;HA2315 UKC315D1;HE2315X	7.4803	2 1/4	0.157	2.874	UK315D1;HA2315 UK315D1;HE2315X	C315D1 C315D1	17
70 2 11/16 3 3/4	UKC316D1;H2316X	200	60	4	78	UK316D1;H2316X	C316D1	9.4
	UKC316D1;HA2316 UKC316D1;HE2316X	7.8740	2 3/4	0.157	3.071	UK316D1;HA2316 UK316D1;HE2316X	C316D1 C316D1	21
75 2 15/16 3	UKC317D1;H2317X	215	64	4	82	UK317D1;H2317X	C317D1	11
	UKC317D1;HA2317X UKC317D1;HE2317X	8.4646	2 3/4	0.157	3.228	UK317D1;HA2317X UK317D1;HE2317X	C317D1 C317D1	24
80 3 3/16	UKC318D1;H2318X	225	66	4	86	UK318D1;H2318X	C318D1	13
	UKC318D1;HA2318X	8.8583	2 19/32	0.157	3.386	UK318D1;HA2318X	C318D1	29
85 3 1/4	UKC319D1;H2319X	240	72	4	90	UK319D1;H2319X	C319D1	16
	UKC319D1;HE2319X	9.4488	2 53/64	0.157	3.543	UK319D1;HE2319X	C319D1	35
90 3 7/16 3 1/2	UKC320D1;H2320X	260	75	4	97	UK320D1;H2320X	C320D1	20
	UKC320D1;HA2320 UKC320D1;HE2320X	10.2362	2 61/64	0.157	3.819	UK320D1;HA2320 UK320D1;HE2320X	C320D1 C320D1	44
100	UKC322D1;H2322X	300	80	5	105	UK322D1;H2322X	C322D1	29
110	UKC324D1;H2324	320	90	5	112	UK324D1;H2324	C324D1	35
115	UKC326D1;H2326	340	100	5	121	UK326D1;H2326	C326D1	43
125	UKC328D1;H2328	360	100	5	131	UK328D1;H2328	C328D1	50

Notes <sup>(1)</sup> These numbers indicate relubricatable type. If maintenance free type is needed, please order without suffix "D1".

<sup>(2)</sup> Adapter number with suffix "X" means a narrow slot type adapter sleeve.

In this case the lock washer with the straight inner prong should be used.

Remarks Please refer to page A21 for size of grease fitting.

## Cartridge unit, cast housing Adapter type

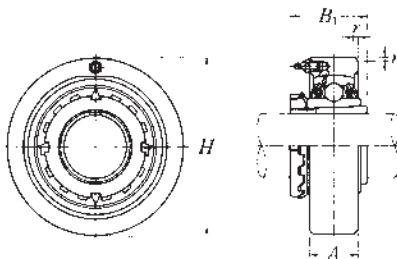

Shaft dia.  mm inch	Unit number <sup>(1)</sup> / <sub>(2)</sub> / <sub>(3)</sub>	Nominal dimensions				Bearing number	Housing number	Mass of unit  kg lb
		mm inch						
		H	A	r	B <sub>1</sub>			
20  3/4	UKCX05D1;H2305X	90	27	2	35	UKX05D1;H2305X	CX05D1	1.1
	UKCX05D1;HE2305	3.5433	1 1/16	0.079	1.378	UKX05D1;HE2305	CX05D1	2.4
25  7/8 1	UKCX06D1;H2306X	100	30	2.5	38	UKX06D1;H2306X	CX06D1	1.4
	UKCX06D1;HS2306 UKCX06D1;HE2306X	3.9370	1 3/16	0.098	1.496	UKX06D1;HS2306 UKX06D1;HE2306X	CX06D1 CX06D1	3.1
30  1 1/8	UKCX07D1;H2307X	110	34	2.5	43	UKX07D1;H2307X	CX07D1	1.8
	UKCX07D1;HS2307	4.3307	1 1/32	0.098	1.693	UKX07D1;HS2307	CX07D1	4.0
35  1 1/4 1 3/8	UKCX08D1;H2308X	120	38	2.5	46	UKX08D1;H2308X	CX08D1	2.5
	UKCX08D1;HE2308X UKCX08D1;HS2308X	4.7244	1 1/2	0.098	1.811	UKX08D1;HE2308X UKX08D1;HS2308X	CX08D1 CX08D1	5.5
40  1 7/16 1 1/2 1 5/8	UKCX09D1;H2309X	120	38	2.5	50	UKX09D1;H2309X	CX09D1	2.2
	UKCX09D1;HA2309 UKCX09D1;HE2309X UKCX09D1;HS2309X	4.7244	1 1/2	0.098	1.969	UKX09D1;HA2309 UKX09D1;HE2309X UKX09D1;HS2309X	CX09D1 CX09D1 CX09D1	4.9
45  1 5/8 1 11/16 1 3/4	UKCX10D1;H2310X	130	40	2.5	55	UKX10D1;H2310X	CX10D1	2.7
	UKCX10D1;HS2310 UKCX10D1;HA2310 UKCX10D1;HE2310X	5.1181	1 37/64	0.098	2.165	UKX10D1;HS2310 UKX10D1;HA2310 UKX10D1;HE2310X	CX10D1 CX10D1 CX10D1	6.0
50  1 7/8 1 15/16 2	UKCX11D1;H2311X	150	42	3	59	UKX11D1;H2311X	CX11D1	4.0
	UKCX11D1;HS2311 UKCX11D1;HA2311 UKCX11D1;HE2311XY	5.9055	1 23/32	0.118	2.323	UKX11D1;HS2311 UKX11D1;HA2311 UKX11D1;HE2311XY	CX11D1 CX11D1 CX11D1	8.8
55  2 1/8	UKCX12D1;H2312X	160	44	3	62	UKX12D1;H2312X	CX12D1	3.9
	UKCX12D1;HS2312	6.2992	1 57/64	0.118	2.441	UKX12D1;HS2312	CX12D1	8.6

Notes <sup>(1)</sup> These numbers indicate relubricatable type. If maintenance free type is needed, please order without suffix "D1".

<sup>(2)</sup> Adapter number with suffix "X" means a narrow slot type adapter sleeve. In this case the lock washer with the straight inner prong should be used.

<sup>(3)</sup> For HE2311XY, screw thread pitch different from the standard is applied, because of the thin thread section of sleeve. To distinguish it, a suffix "Y" is added.

Remarks Please refer to page A21 for size of grease fitting.



## Ball bearings Set screw type

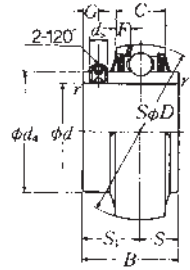

Shaft dia.	Bearing (°) number	Nominal dimensions										
		<i>d</i>	<i>D</i>	<i>B</i>	<i>C</i>	<i>r</i> min.	mm inch		<i>G</i>	<i>d<sub>s</sub></i>	<i>d<sub>4</sub></i>	<i>F</i>
12 ½	<b>UC201D1</b>	12	47	31	17	0.6	12.7	18.3	4.5	M5×0.8	29.6	4.7
	<b>UC201-008D1</b>	0.5000	1.8504	1.2205	0.6693	0.024	0.500	0.720	0.177	No.10-32UNF	1.1654	0.185
15 ⅝ 9/16 5/8	<b>UC202D1</b>	15	47	31	17	0.6	12.7	18.3	4.5	M5×0.8	29.6	4.7
	<b>UC202-009D1</b> <b>UC202-010D1</b>	0.5625 0.6250	1.8504	1.2205	0.6693	0.024	0.500	0.720	0.177	No.10-32UNF	1.1654	0.185
17 1 1/16	<b>UC203D1</b>	17	47	31	17	0.6	12.7	18.3	4.5	M5×0.8	29.6	4.7
	<b>UC203-011D1</b>	0.6875	1.8504	1.2205	0.6693	0.024	0.500	0.720	0.177	No.10-32UNF	1.1654	0.185
20 ¾	<b>UC204D1</b>	20	47	31	17	1	12.7	18.3	4.5	M5×0.8	29.6	4.7
	<b>UC204-012D1</b>	0.7500	1.8504	1.2205	0.6693	0.039	0.500	0.720	0.177	No.10-32UNF	1.1654	0.185
25 1 3/16 7/8 15/16 1	<b>UC205D1</b>	25	52	34.1	17	1	14.3	19.8	5	M5×0.8	33.9	4.5
	<b>UC205-013D1</b>	0.8125										
	<b>UC205-014D1</b>	0.8750	2.0472	1.3425	0.6693	0.039	0.563	0.780	0.197	No.10-32UNF	1.3346	0.177
	<b>UC205-015D1</b> <b>UC205-100D1</b>	0.9375 1.0000										
30 1 1/16 1 1/8 1 3/16 1 1/4	<b>UC206D1</b>	30	62	38.1	19	1	15.9	22.2	5	M6×0.75	40.8	4.6
	<b>UC206-101D1</b>	1.0625										
	<b>UC206-102D1</b>	1.1250	2.4409	1.5000	0.7480	0.039	0.626	0.874	0.197	¼-28UNF	1.6063	0.181
	<b>UC206-103D1</b> <b>UC206-104D1</b>	1.1875 1.2500										
35 1 ¼ 1 5/16 1 ¾ 1 15/16	<b>UC207D1</b>	35	72	42.9	20	1.5	17.5	25.4	6	M6×0.75	46.8	4.6
	<b>UC207-104D1</b>	1.2500										
	<b>UC207-105D1</b>	1.3125	2.8346	1.6890	0.7874	0.059	0.689	1.000	0.236	¼-28UNF	1.8425	0.181
	<b>UC207-106D1</b> <b>UC207-107D1</b>	1.3750 1.4375										
40 1 ½ 1 5/8	<b>UC208D1</b>	40	80	49.2	21	1.5	19	30.2	8	M8×1	53	4.5
	<b>UC208-108D1</b>	1.5000										
	<b>UC208-109D1</b>	1.5625	3.1496	1.9370	0.8268	0.059	0.748	1.189	0.315	5/16-24UNF	2.0866	0.177
45 1 5/8 1 11/16 1 ¾	<b>UC209D1</b>	45	85	49.2	22	1.5	19	30.2	8	M8×1	57.5	4.9
	<b>UC209-110D1</b>	1.6250										
	<b>UC209-111D1</b> <b>UC209-112D1</b>	1.6875 1.7500	3.3465	1.9370	0.8661	0.059	0.748	1.189	0.315	5/16-24UNF	2.2638	0.193

Note (°) These numbers indicate relubricatable type. If maintenance free type is needed, please order without suffix "D1".

Basic load ratings		Mass
dynamic	static	kg lb
$C_r$	$C_{0r}$	
12 800	6 650	0.21
2 890	1 500	0.46
12 800	6 650	0.20
2 890	1 500	0.44
		0.42
12 800	6 650	0.18
2 890	1 500	0.39
12 800	6 650	0.17
2 890	1 500	0.39
14 000	7 850	0.20
		0.53
3 150	1 770	0.51
		0.46
		0.44
19 500	11 300	0.32
		0.82
4 400	2 540	0.77
		0.73
		0.66
25 700	15 300	0.46
		1.21
5 750	3 450	1.15
		1.08
		1.01
29 100	17 800	0.64
		1.52
6 550	4 000	1.46
32 500	20 400	0.68
		1.76
7 350	4 600	1.68
		1.57



## Ball bearings Set screw type

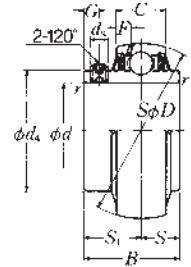

Shaft dia.	Bearing (1) number	Nominal dimensions										
		<i>d</i>	<i>D</i>	<i>B</i>	<i>C</i>	<i>r</i> min.	mm inch		<i>G</i>	<i>d<sub>s</sub></i>	<i>d<sub>4</sub></i>	<i>F</i>
50	<b>UC210D1</b>	50	90	51.6	24	1.5	19	32.6	9	M8×1	62.4	5.9
1 <sup>3</sup> / <sub>16</sub>	<b>UC210-113D1</b>	1.8125										
1 <sup>7</sup> / <sub>16</sub>	<b>UC210-114D1</b>	1.8750	3.5433	2.0315	0.9449	0.059	0.748	1.283	0.354	5/16-24UNF	2.4567	0.232
1 <sup>5</sup> / <sub>16</sub>	<b>UC210-115D1</b>	1.9375										
2	<b>UC210-200D1</b>	2.0000										
55	<b>UC211D1</b>	55	100	55.6	25	2	22.2	33.4	9	M8×1	69	6.0
2	<b>UC211-200D1</b>	2.0000										
2 <sup>1</sup> / <sub>16</sub>	<b>UC211-201D1</b>	2.0625	3.9370	2.1890	0.9843	0.079	0.874	1.315	0.354	5/16-24UNF	2.7165	0.236
2 <sup>3</sup> / <sub>16</sub>	<b>UC211-202D1</b>	2.1250										
2 <sup>3</sup> / <sub>16</sub>	<b>UC211-203D1</b>	2.1875										
60	<b>UC212D1</b>	60	110	65.1	27	2	25.4	39.7	10	M10×1.25	77	6.2
2 <sup>1</sup> / <sub>4</sub>	<b>UC212-204D1</b>	2.2500										
2 <sup>1</sup> / <sub>16</sub>	<b>UC212-205D1</b>	2.3125	4.3307	2.5630	1.0630	0.079	1.000	1.563	0.394	3/8-24UNF	3.0315	0.244
2 <sup>3</sup> / <sub>8</sub>	<b>UC212-206D1</b>	2.3750										
2 <sup>1</sup> / <sub>16</sub>	<b>UC212-207D1</b>	2.4375										
65	<b>UC213D1</b>	65	120	65.1	32	2	25.4	39.7	10	M10×1.25	82.5	8.7
2 <sup>1</sup> / <sub>2</sub>	<b>UC213-208D1</b>	2.5000	4.7244	2.5630	1.2598	0.079	1.000	1.563	0.394	3/8-24UNF	3.2480	0.343
2 <sup>1</sup> / <sub>16</sub>	<b>UC213-209D1</b>	2.5625										
70	<b>UC214D1</b>	70	125	74.6	33	2	30.2	44.4	12	M10×1.25	87	8.8
2 <sup>5</sup> / <sub>8</sub>	<b>UC214-210D1</b>	2.6250										
2 <sup>1</sup> / <sub>16</sub>	<b>UC214-211D1</b>	2.6875	4.9213	2.9370	1.2992	0.079	1.189	1.748	0.472	3/8-24UNF	3.4252	0.346
2 <sup>3</sup> / <sub>4</sub>	<b>UC214-212D1</b>	2.7500										
75	<b>UC215D1</b>	75	130	77.8	34	2	33.3	44.5	12	M10×1.25	93	9.0
2 <sup>3</sup> / <sub>16</sub>	<b>UC215-213D1</b>	2.8125										
2 <sup>7</sup> / <sub>8</sub>	<b>UC215-214D1</b>	2.8750	5.1181	3.0630	1.3386	0.079	1.311	1.752	0.472	3/8-24UNF	3.6614	0.354
2 <sup>9</sup> / <sub>16</sub>	<b>UC215-215D1</b>	2.9375										
3	<b>UC215-300D1</b>	3.0000										
80	<b>UC216D1</b>	80	140	82.6	35	2.5	33.3	49.3	12	M10×1.25	98.1	9.5
3 <sup>1</sup> / <sub>16</sub>	<b>UC216-301D1</b>	3.0625										
3 <sup>1</sup> / <sub>8</sub>	<b>UC216-302D1</b>	3.1250	5.5118	3.2520	1.3780	0.098	1.311	1.941	0.472	3/8-24UNF	3.8622	0.374
3 <sup>3</sup> / <sub>16</sub>	<b>UC216-303D1</b>	3.1875										

Note (1) These numbers indicate relubricatable type. If maintenance free type is needed, please order without suffix "D1".

<b>Basic load ratings</b>		<b>Mass</b>
<b>N lbf</b>		<b>kg lb</b>
dynamic $C_r$	static $C_{0r}$	
35 000	23 200	0.78 2.03
7 900	5 200	1.92 1.81 1.69
43 500	29 200	1.04 2.71
9 750	6 550	2.60 2.46 2.34
52 500	36 000	1.46 3.66
11 800	8 150	3.50 3.33 3.17
57 500	40 000	1.86 4.26
12 900	9 000	4.09
62 000	44 000	2.10 5.09
14 000	9 900	4.87 4.65
66 000	49 500	2.34 5.73
14 900	11 100	5.49 5.25 4.98
72 500	53 000	2.78 6.57
16 300	11 900	6.28 6.00

## Ball bearings Set screw type

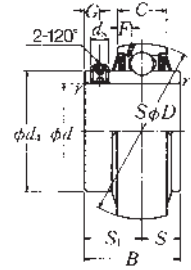

Shaft dia.	Bearing (1) number	Nominal dimensions										
		<i>d</i>	<i>D</i>	<i>B</i>	<i>C</i>	<i>r</i> min.	<i>S</i>	<i>S</i> <sub>1</sub>	<i>G</i>	<i>d</i> <sub>s</sub>	<i>d</i> <sub>4</sub>	<i>F</i>
85	<b>UC217D1</b>	85	150	85.7	36	2.5	34.1	51.6	12	M12x1.5	106.4	10.1
3 1/4	<b>UC217-304D1</b>	3.2500										
3 5/16	<b>UC217-305D1</b>	3.3125	5.9055	3.3740	1.4173	0.098	1.343	2.031	0.472	1/2-20UNF	4.1890	0.398
3 7/16	<b>UC217-307D1</b>	3.4375										
90	<b>UC218D1</b>	90	160	96	37	2.5	39.7	56.3	12	M12x1.5	111.6	9.8
3 1/2	<b>UC218-308D1</b>	3.5000	6.2992	3.7795	1.4567	0.098	1.563	2.217	0.472	1/2-20UNF	4.3937	0.386

Note (1) These numbers indicate relubricatable type. If maintenance free type is needed, please order without suffix "D1".

<b>Basic load ratings</b>		<b>Mass</b>
<b>N lbf</b>		<b>kg lb</b>
dynamic $C_r$	static $C_{0r}$	
83 500	64 000	3.54
18 700	14 300	7.92
		7.60
		6.97
96 000	71 500	4.40
21 600	16 100	9.88

## Ball bearings Set screw type

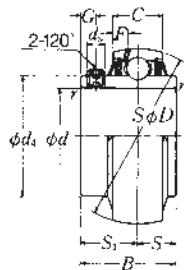

Shaft dia.	Bearing (1) number	Nominal dimensions										
		<i>d</i>	<i>D</i>	<i>B</i>	<i>C</i>	<i>r</i> min.	<i>S</i>	<i>S</i> <sub>1</sub>	<i>G</i>	<i>d</i> <sub>s</sub>	<i>d</i> <sub>4</sub>	<i>F</i>
25	<b>UC305D1</b>	25	62	38	20	1.5	15	23	6	M6×0.75	36.8	5.0
<sup>13</sup> / <sub>16</sub>	<b>UC305-013D1</b>	0.8125										
<sup>7</sup> / <sub>8</sub>	<b>UC305-014D1</b>	0.8750	2.4409	1.4961	0.7874	0.059	0.591	0.906	0.236	<sup>1</sup> / <sub>4</sub> -28UNF	1.4488	0.197
<sup>15</sup> / <sub>16</sub>	<b>UC305-015D1</b>	0.9375										
1	<b>UC305-100D1</b>	1.0000										
30	<b>UC306D1</b>	30	72	43	23	1.5	17	26	6	M6×0.75	44.9	5.9
<sup>1</sup> / <sub>16</sub>	<b>UC306-101D1</b>	1.0625										
<sup>1</sup> / <sub>8</sub>	<b>UC306-102D1</b>	1.1250	2.8346	1.6929	0.9055	0.059	0.669	1.024	0.236	<sup>1</sup> / <sub>4</sub> -28UNF	1.7677	0.232
<sup>1</sup> / <sub>16</sub>	<b>UC306-103D1</b>	1.1875										
35	<b>UC307D1</b>	35	80	48	25	2	19	29	8	M8×1	49.4	6.8
<sup>1</sup> / <sub>4</sub>	<b>UC307-104D1</b>	1.2500										
<sup>5</sup> / <sub>16</sub>	<b>UC307-105D1</b>	1.3125	3.1496	1.8898	0.9843	0.079	0.748	1.142	0.315	<sup>5</sup> / <sub>16</sub> -24UNF	1.9449	0.268
<sup>7</sup> / <sub>8</sub>	<b>UC307-106D1</b>	1.3750										
<sup>1</sup> / <sub>16</sub>	<b>UC307-107D1</b>	1.4375										
40	<b>UC308D1</b>	40	90	52	27	2	19	33	10	M10×1.25	56	7.4
<sup>1</sup> / <sub>2</sub>	<b>UC308-108D1</b>	1.5000	3.5433	2.0472	1.0630	0.079	0.748	1.299	0.394	<sup>3</sup> / <sub>8</sub> -24UNF	2.2047	0.291
<sup>1</sup> / <sub>16</sub>	<b>UC308-109D1</b>	1.5625										
45	<b>UC309D1</b>	45	100	57	29	2	22	35	10	M10×1.25	63.5	7.4
<sup>5</sup> / <sub>8</sub>	<b>UC309-110D1</b>	1.6250										
<sup>1</sup> / <sub>16</sub>	<b>UC309-111D1</b>	1.6875	3.9370	2.2441	1.1417	0.079	0.866	1.378	0.394	<sup>3</sup> / <sub>8</sub> -24UNF	2.5000	0.291
<sup>3</sup> / <sub>4</sub>	<b>UC309-112D1</b>	1.7500										
50	<b>UC310D1</b>	50	110	61	32	2.5	22	39	12	M12×1.5	70.6	8.1
<sup>1</sup> / <sub>16</sub>	<b>UC310-113D1</b>	1.8125										
<sup>1</sup> / <sub>8</sub>	<b>UC310-114D1</b>	1.8750	4.3307	2.4016	1.2598	0.098	0.866	1.535	0.472	<sup>1</sup> / <sub>2</sub> -20UNF	2.7795	0.319
<sup>1</sup> / <sub>16</sub>	<b>UC310-115D1</b>	1.9375										

Note (1) These numbers indicate relubricatable type. If maintenance free type is needed, please order without suffix "D1".

Basic load ratings		Mass
dynamic	static	kg lb
$C_r$	$C_{0r}$	
21 200	10 900	0.35 0.88
4 750	2 460	0.84 0.79 0.77
26 700	15 000	0.56 1.34
6 000	3 400	1.28 1.23
33 500	19 100	0.70 1.70
7 500	4 300	1.63 1.57 1.50
40 500	24 000	0.96 2.23
9 150	5 400	2.14
53 000	32 000	1.28 3.06
11 900	7 200	2.98 2.87
62 000	38 500	1.68 3.95
13 900	8 600	3.84 3.70

## Ball bearings Set screw type

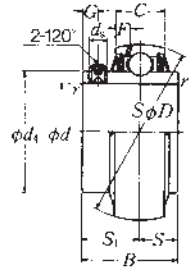

Shaft dia.	Bearing <sup>(1)</sup> number	Nominal dimensions										
		<i>d</i>	<i>D</i>	<i>B</i>	<i>C</i>	<i>r</i>	mm		inch		<i>d<sub>s</sub></i>	<i>d<sub>4</sub></i>
mm inch						min.	<i>S</i>	<i>S<sub>1</sub></i>	<i>G</i>			
55	<b>UC311D1</b>	55	120	66	34	2.5	25	41	12			
2	<b>UC311-200D1</b>	2.0000										
2 1/16	<b>UC311-201D1</b>	2.0625	4.7244	2.5984	1.3386	0.098	0.984	1.614	0.472	1/2-20UNF	3.0157	0.335
2 3/8	<b>UC311-202D1</b>	2.1250										
2 7/16	<b>UC311-203D1</b>	2.1875										
60	<b>UC312D1</b>	60	130	71	36	2.5	26	45	12			
2 1/4	<b>UC312-204D1</b>	2.2500										
2 5/16	<b>UC312-205D1</b>	2.3125	5.1181	2.7953	1.4173	0.098	1.024	1.772	0.472	1/2-20UNF	3.2559	0.354
2 3/8	<b>UC312-206D1</b>	2.3750										
2 7/16	<b>UC312-207D1</b>	2.4375										
65	<b>UC313D1</b>	65	140	75	39	2.5	30	45	12			
2 1/2	<b>UC313-208D1</b>	2.5000	5.5118	2.9528	1.5354	0.098	1.181	1.772	0.472	1/2-20UNF	3.4724	0.398
2 5/8	<b>UC313-209D1</b>	2.5625										
70	<b>UC314D1</b>	70	150	78	41	2.5	33	45	12			
2 5/8	<b>UC314-210D1</b>	2.6250										
2 7/16	<b>UC314-211D1</b>	2.6875	5.9055	3.0709	1.6142	0.098	1.299	1.772	0.472	1/2-20UNF	3.7323	0.413
2 3/4	<b>UC314-212D1</b>	2.7500										
75	<b>UC315D1</b>	75	160	82	43	2.5	32	50	14			
2 3/8	<b>UC315-213D1</b>	2.8125										
2 7/8	<b>UC315-214D1</b>	2.8750	6.2992	3.2283	1.6929	0.098	1.260	1.969	0.551	9/16-18UNF	3.9882	0.433
2 5/8	<b>UC315-215D1</b>	2.9375										
3	<b>UC315-300D1</b>	3.0000										
80	<b>UC316D1</b>	80	170	86	45	2.5	34	52	14			
3 1/16	<b>UC316-301D1</b>	3.0625										
3 3/8	<b>UC316-302D1</b>	3.1250	6.6929	3.3858	1.7717	0.098	1.339	2.047	0.551	9/16-18UNF	4.2480	0.449
3 5/16	<b>UC316-303D1</b>	3.1875										

Note (1) These numbers indicate relubricatable type. If maintenance free type is needed, please order without suffix "D1".

Basic load ratings		Mass
dynamic	static	kg lb
$C_r$	$C_{0r}$	
71 500	45 000	2.08 4.96
16 100	10 100	4.81 4.67 4.50
82 000	52 000	2.60 6.06
18 400	11 700	5.89 5.68 5.51
92 500	60 000	3.25 7.36
20 800	13 400	7.14
104 000	68 000	3.86 9.06
23 400	15 300	8.82 8.60
113 000	77 000	4.70 11.0
25 500	17 400	10.7 10.5 10.2
123 000	86 500	5.60 12.6
27 600	19 500	12.3 12.1



## Ball bearings Set screw type

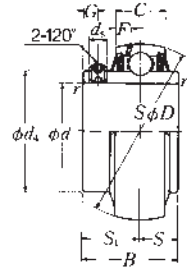

Shaft dia.	Bearing (1) number	Nominal dimensions										
		<i>d</i>	<i>D</i>	<i>B</i>	<i>C</i>	<i>r</i> min.	<i>S</i>	<i>S</i> <sub>1</sub>	<i>G</i>	<i>d</i> <sub>s</sub>	<i>d</i> <sub>4</sub>	<i>F</i>
85	<b>UC317D1</b>	85	180	96	47	3	40	56	16	M16×1.5	114.4	12.0
3 <sup>3</sup> / <sub>4</sub>	<b>UC317-304D1</b>	3.2500										
3 <sup>7</sup> / <sub>16</sub>	<b>UC317-305D1</b>	3.3125	7.0866	3.7795	1.8504	0.118	1.575	2.205	0.630	<sup>5</sup> / <sub>8</sub> -18UNF	4.5039	0.472
3 <sup>7</sup> / <sub>16</sub>	<b>UC317-307D1</b>	3.4375										
90	<b>UC318D1</b>	90	190	96	49	3	40	56	16	M16×1.5	120.9	12.3
3 <sup>3</sup> / <sub>16</sub>	<b>UC318-307D1</b>	3.4375										
3 <sup>1</sup> / <sub>2</sub>	<b>UC318-308D1</b>	3.5000	7.4803	3.7795	1.9291	0.118	1.575	2.205	0.630	<sup>5</sup> / <sub>8</sub> -18UNF	4.7598	0.484
95	<b>UC319D1</b>	95	200	103	51	3	41	62	16	M16×1.5	127.5	12.8
3 <sup>5</sup> / <sub>8</sub>	<b>UC319-310D1</b>	3.6250										
3 <sup>11</sup> / <sub>16</sub>	<b>UC319-311D1</b>	3.6875	7.8740	4.0551	2.0079	0.118	1.614	2.441	0.630	<sup>5</sup> / <sub>8</sub> -18UNF	5.0197	0.504
3 <sup>3</sup> / <sub>4</sub>	<b>UC319-312D1</b>	3.7500										
100	<b>UC320D1</b>	100	215	108	55	3	42	66	18	M18×1.5	135.6	13.5
3 <sup>13</sup> / <sub>16</sub>	<b>UC320-313D1</b>	3.8125										
3 <sup>7</sup> / <sub>8</sub>	<b>UC320-314D1</b>	3.8750										
3 <sup>15</sup> / <sub>16</sub>	<b>UC320-315D1</b>	3.9375	8.4646	4.2520	2.1654	0.118	1.654	2.598	0.709	<sup>5</sup> / <sub>8</sub> -18UNF	5.3386	0.531
4	<b>UC320-400D1</b>	4.0000										
105	<b>UC321D1</b>	105	225	112	57	3	44	68	18	M18×1.5	142.1	13.9
110	<b>UC322D1</b>	110	240	117	59	3	46	71	18	M18×1.5	151.7	13.9
120	<b>UC324D1</b>	120	260	126	63	3	51	75	18	M18×1.5	165.2	16.0
130	<b>UC326D1</b>	130	280	135	67	4	54	81	20	M20×1.5	178.3	16.9
140	<b>UC328D1</b>	140	300	145	71	4	59	86	20	M20×1.5	190.4	17.7

Note (1) These numbers indicate relubricatable type. If maintenance free type is needed, please order without suffix "D1".

<b>Basic load ratings</b>		<b>Mass</b>
<b>N lbf</b>		<b>kg lb</b>
dynamic $C_r$	static $C_{0r}$	
133 000	97 000	6.70
		15.2
29 800	21 800	14.9
		14.2
143 000	107 000	7.60
		17.3
32 000	24 100	16.9
153 000	119 000	8.70
		19.9
34 500	26 600	19.5
		19.1
173 000	141 000	10.8
		24.7
		24.2
39 000	31 500	23.8
		23.4
184 000	153 000	12.2
205 000	179 000	14.3
207 000	185 000	18.5
229 000	214 000	23.0
253 000	246 000	28.5

## Ball bearings Set screw type

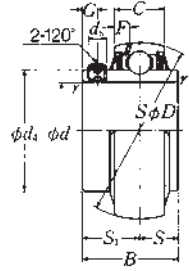

Shaft dia.	Bearing (¹) number	Nominal dimensions										
		<i>d</i>	<i>D</i>	<i>B</i>	<i>C</i>	<i>r</i> min.	mm inch		<i>G</i>	<i>d<sub>s</sub></i>	<i>d<sub>4</sub></i>	<i>F</i>
25	<b>UCX05D1</b>	25	62	38.1	19	1	15.9	22.2	5	M6×0.75	40.8	4.6
$\frac{13}{16}$	<b>UCX05-013D1</b>	0.8125										
$\frac{7}{8}$	<b>UCX05-014D1</b>	0.8750	2.4409	1.5000	0.7480	0.039	0.626	0.874	0.197	$\frac{1}{4}$ -28UNF	1.6063	0.181
$\frac{15}{16}$	<b>UCX05-015D1</b>	0.9375										
1	<b>UCX05-100D1</b>	1.0000										
30	<b>UCX06D1</b>	30	72	42.9	20	1	17.5	25.4	6	M8×1	46.8	4.6
$1\frac{1}{8}$	<b>UCX06-101D1</b>	1.0625										
$1\frac{1}{8}$	<b>UCX06-102D1</b>	1.1250	2.8346	1.6890	0.7874	0.039	0.689	1.000	0.236	$\frac{5}{16}$ -24UNF	1.8425	0.181
$1\frac{3}{8}$	<b>UCX06-103D1</b>	1.1875										
35	<b>UCX07D1</b>	35	80	49.2	21	1.5	19	30.2	8	M8×1	53	4.5
$1\frac{5}{8}$	<b>UCX07-105D1</b>	1.3125										
$1\frac{3}{8}$	<b>UCX07-106D1</b>	1.3750	3.1496	1.9370	0.8268	0.059	0.748	1.189	0.315	$\frac{5}{16}$ -24UNF	2.0866	0.177
$1\frac{7}{8}$	<b>UCX07-107D1</b>	1.4375										
40	<b>UCX08D1</b>	40	85	49.2	22	1.5	19	30.2	8	M8×1	57.5	4.9
$1\frac{1}{2}$	<b>UCX08-108D1</b>	1.5000										
$1\frac{5}{8}$	<b>UCX08-109D1</b>	1.5625	3.3465	1.9370	0.8661	0.059	0.748	1.189	0.315	$\frac{5}{16}$ -24UNF	2.2638	0.193
45	<b>UCX09D1</b>	45	90	51.6	24	1.5	19	32.6	9	M10×1.25	62.4	5.9
$1\frac{5}{8}$	<b>UCX09-110D1</b>	1.6250										
$1\frac{11}{16}$	<b>UCX09-111D1</b>	1.6875	3.5433	2.0315	0.9449	0.059	0.748	1.283	0.354	$\frac{3}{8}$ -24UNF	2.4567	0.232
$1\frac{3}{4}$	<b>UCX09-112D1</b>	1.7500										
50	<b>UCX10D1</b>	50	100	55.6	25	1.5	22.2	33.4	9	M10×1.25	69	6.0
$1\frac{7}{8}$	<b>UCX10-114D1</b>	1.8750										
$1\frac{5}{8}$	<b>UCX10-115D1</b>	1.9375	3.9370	2.1890	0.9843	0.059	0.874	1.315	0.354	$\frac{3}{8}$ -24UNF	2.7165	0.236
55	<b>UCX11D1</b>	55	110	65.1	27	2	25.4	39.7	10	M10×1.25	77	6.2
$2\frac{1}{8}$	<b>UCX11-201D1</b>	2.0625										
$2\frac{1}{8}$	<b>UCX11-202D1</b>	2.1250	4.3307	2.5630	1.0630	0.079	1.000	1.563	0.394	$\frac{3}{8}$ -24UNF	3.0315	0.244
$2\frac{3}{8}$	<b>UCX11-203D1</b>	2.1875										
60	<b>UCX12D1</b>	60	120	65.1	32	2	25.4	39.7	10	M10×1.25	82.5	8.7
$2\frac{3}{8}$	<b>UCX12-206D1</b>	2.3750										
$2\frac{1}{2}$	<b>UCX12-207D1</b>	2.4375	4.7244	2.5630	1.2598	0.079	1.000	1.563	0.394	$\frac{3}{8}$ -24UNF	3.2480	0.343

Note (¹) These numbers indicate relubricatable type. If maintenance free type is needed, please order without suffix "D1".

Basic load ratings		Mass
dynamic	static	kg lb
$C_r$	$C_{0r}$	
19 500	11 300	0.39 0.97
4 400	2 540	0.93 0.88 0.84
25 700	15 300	0.68 1.61
5 750	3 450	1.54 1.50
29 100	17 800	0.74 1.87
6 550	4 000	1.81 1.74
32 500	20 400	0.80 2.16 2.07
35 000	23 200	0.94 2.43
7 900	5 200	2.34 2.25
43 500	29 200	1.22 3.15 3.04
9 750	6 550	
52 500	36 000	1.72 4.43 4.30 4.12
11 800	8 150	
57 500	40 000	2.10 4.96 4.81
12 900	9 000	

## Ball bearings Set screw type

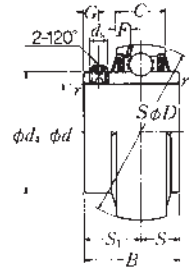

Shaft dia.	Bearing (°) number	Nominal dimensions										
		<i>d</i>	<i>D</i>	<i>B</i>	<i>C</i>	<i>r</i> min.	mm inch		<i>G</i>	<i>d<sub>s</sub></i>	<i>d<sub>4</sub></i>	<i>F</i>
65	<b>UCX13D1</b>	65	125	74.6	33	2	30.2	44.4	12	M12x1.5	87	8.8
2 1/2	<b>UCX13-208D1</b>	2.5000	4.9213	2.9370	1.2992	0.079	1.189	1.748	0.472	1/2-20UNF	3.4252	0.346
2 5/16	<b>UCX13-209D1</b>	2.5625										
70	<b>UCX14D1</b>	70	130	77.8	34	2	33.3	44.5	12	M12x1.5	93	9.0
2 5/8	<b>UCX14-210D1</b>	2.6250										
2 11/16	<b>UCX14-211D1</b>	2.6875	5.1181	3.0630	1.3386	0.079	1.311	1.752	0.472	1/2-20UNF	3.6614	0.354
2 3/4	<b>UCX14-212D1</b>	2.7500										
75	<b>UCX15D1</b>	75	140	82.6	35	2	33.3	49.3	12	M12x1.5	98.1	9.5
2 3/8	<b>UCX15-213D1</b>	2.8125										
2 7/8	<b>UCX15-214D1</b>	2.8750	5.5118	3.2520	1.3780	0.079	1.311	1.941	0.472	1/2-20UNF	3.8622	0.374
2 9/16	<b>UCX15-215D1</b>	2.9375										
3	<b>UCX15-300D1</b>	3.0000										
80	<b>UCX16D1</b>	80	150	85.7	36	2.5	34.1	51.6	12	M12x1.5	106.4	10.1
3 1/16	<b>UCX16-301D1</b>	3.0625										
3 3/8	<b>UCX16-302D1</b>	3.1250	5.9055	3.3740	1.4173	0.098	1.343	2.031	0.472	1/2-20UNF	4.1890	0.398
3 5/16	<b>UCX16-303D1</b>	3.1875										
85	<b>UCX17D1</b>	85	160	96	37	2.5	39.7	56.3	12	M12x1.5	111.6	9.8
3 5/16	<b>UCX17-305D1</b>	3.3125	6.2992	3.7795	1.4567	0.098	1.563	2.217	0.472	1/2-20UNF	4.3937	0.386
3 7/16	<b>UCX17-307D1</b>	3.4375										
90	<b>UCX18D1</b>	90	170	104	39	2.5	42.9	61.1	14	M14x1.5	118.2	10.5
3 7/16	<b>UCX18-307D1</b>	3.4375	6.6929	4.0945	1.5354	0.098	1.689	2.406	0.551	9/16-18UNF	4.6535	0.413
3 1/2	<b>UCX18-308D1</b>	3.5000										
100	<b>UCX20D1</b>	100	190	117.5	44	2.5	49.2	68.3	16	M16x1.5	131.3	11.3
3 13/16	<b>UCX20-313D1</b>	3.8125										
3 7/8	<b>UCX20-314D1</b>	3.8750	7.4803	4.6260	1.7323	0.098	1.937	2.689	0.630	5/8-18UNF	5.1693	0.445
3 9/16	<b>UCX20-315D1</b>	3.9375										
4	<b>UCX20-400D1</b>	4.0000										

Note (°) These numbers indicate relubricatable type. If maintenance free type is needed, please order without suffix "D1".

<b>Basic load ratings</b>		<b>Mass</b>
<b>N lbf</b>		<b>kg lb</b>
dynamic $C_r$	static $C_{0r}$	
62 000	44 000	2.45
14 000	9 900	5.60
		5.38
66 000	49 500	2.47
		5.93
14 900	11 100	5.69
		5.47
72 500	53 000	3.11
		7.43
16 300	11 900	7.19
		6.92
		6.66
83 500	64 000	3.96
		8.75
18 700	14 300	8.47
		8.18
96 000	71 500	4.72
		10.8
21 600	16 100	10.1
109 000	82 000	5.50
		13.3
24 500	18 400	12.4
133 000	105 000	8.06
		18.8
29 900	23 500	18.4
		19.7
		19.2

## Ball bearings Set screw type

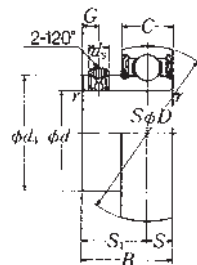

Shaft dia.  mm inch	Bearing (¹) number	Nominal dimensions									
		<i>d</i>	<i>D</i>	<i>B</i>	<i>C</i>	<i>r</i>	<i>S</i>	<i>S</i> <sub>1</sub>	<i>G</i>	<i>d</i> <sub>s</sub>	<i>d</i> <sub>4</sub>
12 ½	<b>AS201</b>	12	40	22	12	0.6	6	16	4.2	M5×0.8	24.3
	<b>AS201-008</b>	0.5000	1.5748	0.8661	0.4724	0.024	0.236	0.630	0.165	No.10-32UNF	0.957
15 9/16 5/8	<b>AS202</b>	15	40	22	12	0.6	6	16	4.2	M5×0.8	24.3
	<b>AS202-009</b> <b>AS202-010</b>	0.5625 0.6250	1.5748	0.8661	0.4724	0.024	0.236	0.630	0.165	No.10-32UNF	0.957
17 1 1/16	<b>AS203</b>	17	40	22	12	0.6	6	16	4.2	M5×0.8	24.3
	<b>AS203-011</b>	0.6875	1.5748	0.8661	0.4724	0.024	0.236	0.630	0.165	No.10-32UNF	0.957
20 ¾	<b>AS204</b>	20	47	25	14	1	7	18	4.2	M5×0.8	29.6
	<b>AS204-012</b>	0.7500	1.8504	0.9843	0.5512	0.039	0.276	0.709	0.165	No.10-32UNF	1.165
25 1 3/16 7/8 1 5/16 1	<b>AS205</b>	25	52	27	15	1	7.5	19.5	5	M5×0.8	33.9
	<b>AS205-013</b>	0.8125									
	<b>AS205-014</b>	0.8750									
	<b>AS205-015</b> <b>AS205-100</b>	0.9375 1.0000	2.0472	1.0630	0.5906	0.039	0.295	0.768	0.197	No.10-32UNF	1.335
30 1 1/16 1 1/8 1 3/16 1 1/4	<b>AS206</b>	30	62	29	16	1	8	21	5	M6×0.75	40.8
	<b>AS206-101</b>	1.0625									
	<b>AS206-102</b>	1.1250									
	<b>AS206-103</b> <b>AS206-104</b>	1.1875 1.2500	2.4409	1.1417	0.6299	0.039	0.315	0.827	0.197	¼-28UNF	1.606
35 1 ¼ 1 5/16 1 3/8 1 7/16	<b>AS207</b>	35	72	34	17	1.5	8.5	25.5	6	M6×0.75	46.8
	<b>AS207-104</b>	1.2500									
	<b>AS207-105</b>	1.3125									
	<b>AS207-106</b> <b>AS207-107</b>	1.3750 1.4375	2.8346	1.3386	0.6693	0.059	0.335	1.004	0.236	¼-28UNF	1.843
40 1 ½ 1 5/8	<b>AS208</b>	40	80	38	18	1.5	9	29	8	M8×1	53
	<b>AS208-108</b> <b>AS208-109</b>	1.5000 1.5625	3.1496	1.4961	0.7087	0.059	0.354	1.142	0.315	5/16-24UNF	2.087

Note (¹) If lubricatable type is needed, please order with suffix "D1".

Basic load ratings		Mass
N lbf		kg lb
dynamic $C_r$	static $C_{0r}$	
9 600	4 600	0.10
2 160	1 030	0.22
9 600	4 600	0.09
2 160	1 030	0.21
		0.20
9 600	4 600	0.08
2 160	1 030	0.18
12 800	6 650	0.13
2 890	1 500	0.29
14 000	7 850	0.16
		0.42
		0.40
3 150	1 770	0.38
		0.35
19 500	11 300	0.25
		0.61
		0.59
4 400	2 540	0.57
		0.55
25 700	15 300	0.38
		1.06
		0.93
5 750	3 450	0.81
		0.69
29 100	17 800	0.51
		1.15
6 550	4 000	1.06



## Ball bearings Set screw type

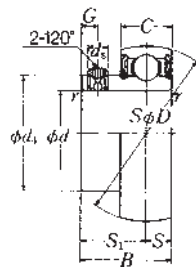

Shaft dia.	Bearing (*) number	Nominal dimensions									
		<i>d</i>	<i>D</i>	<i>B</i>	<i>C</i>	<i>r</i>	<i>S</i>	<i>S</i> <sub>1</sub>	<i>G</i>	<i>d</i> <sub>s</sub>	<i>d</i> <sub>4</sub>
45	<b>AS209</b>	45	85	40	19	1.5	9.5	30.5	8	M8x1	57.5
1 5/8	<b>AS209-110</b>	1.6250									
1 7/8	<b>AS209-111</b>	1.6875	3.3465	1.5748	0.7480	0.059	0.374	1.201	0.315	5/16-24UNF	2.2638
1 3/4	<b>AS209-112</b>	1.7500									
50	<b>AS210</b>	50	90	42	20	1.5	10	32	9	M8x1	62.4
1 9/16	<b>AS210-113</b>	1.8125									
1 7/8	<b>AS210-114</b>	1.8750									
1 5/8	<b>AS210-115</b>	1.9375	3.5433	1.6535	0.7874	0.059	0.394	1.260	0.354	5/16-24UNF	2.4567
2	<b>AS210-200</b>	2.0000									

Note (\*) If relubricatable type is needed, please order with "D1".

<b>Basic load ratings</b>		<b>Mass</b>
dynamic	static	kg lb
$C_r$	$C_{0r}$	
32 500	20 400	0.55 1.39
7 350	4 600	1.32 1.23
35 000	23 200	0.65 1.65
7 900	5 200	1.57 1.48 1.39

## Ball bearings Set screw type

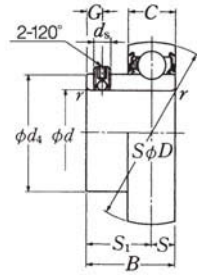

Shaft dia. mm inch	Bearing (°) number	Nominal dimensions									
		<i>d</i>	<i>D</i>	<i>B</i>	<i>C</i>	<i>r</i>	<i>S</i>	<i>S</i> <sub>1</sub>	<i>G</i>	<i>d</i> <sub>s</sub>	<i>d</i> <sub>4</sub>
		mm		mm		inch		mm		mm	
						min.					
12 1/2	AR201 AR201-008	12 0.5000	40 1.5748	22.5 0.8858	13 0.5118	0.6 0.024	6.5 0.256	16 0.630	5 0.197	M6×0.75 1/4-28UNF	24.4 0.9606
15 9/16 5/8	AR202 AR202-009 AR202-010	15 0.5625 0.6250	40 1.5748	22.5 0.8858	13 0.5118	0.6 0.024	6.5 0.256	16 0.630	5 0.197	M6×0.75 1/4-28UNF	24.4 0.9606
17 1 1/16	AR203 AR203-011	17 0.6875	40 1.5748	22.5 0.8858	13 0.5118	0.6 0.024	6.5 0.256	16 0.630	5 0.197	M6×0.75 1/4-28UNF	24.4 0.9606
20 3/4	AR204 AR204-012	20 0.7500	47 1.8504	25.5 1.0039	15 0.5906	1 0.039	7.5 0.295	18 0.709	5 0.197	M6×0.75 1/4-28UNF	29.6 1.1654
25 1 3/16 7/8 1 5/16 1	AR205 AR205-013 AR205-014 AR205-015 AR205-100	25 0.8125 0.8750 0.9375 1.0000	52 2.0472	27 1.0630	15 0.5906	1 0.039	7.5 0.295	19.5 0.768	5 0.197	M6×0.75 1/4-28UNF	33.9 1.3346
30 1 1/16 1 1/8 1 3/16 1 1/4	AR206 AR206-101 AR206-102 AR206-103 AR206-104	30 1.0625 1.1250 1.1875 1.2500	62 2.4409	30 1.1811	18 0.7087	1 0.039	9 0.354	21 0.827	5 0.197	M6×0.75 1/4-28UNF	40.8 1.6063
35 1 1/4 1 5/16 1 3/8 1 7/16	AR207 AR207-104 AR207-105 AR207-106 AR207-107	35 1.2500 1.3125 1.3750 1.4375	72 2.8346	35 1.3780	19 0.7480	1.5 0.059	9.5 0.374	25.5 1.004	6 0.236	M6×0.75 1/4-28UNF	46.8 1.8425
40 1 1/2 1 9/16	AR208 AR208-108 AR208-109	40 1.5000 1.5625	80 3.1496	40 1.5748	22 0.8661	1.5 0.059	11.0 0.433	29 1.142	8 0.315	M8×1 5/16-24UNF	53 2.0866

Note (°) If lubricatable type is needed, please order with suffix "D1".

Basic load ratings		Mass
dynamic	static	kg lb
$C_r$	$C_{or}$	
9 600	4 600	0.11
2 160	1 030	0.24
9 600	4 600	0.10
2 160	1 030	0.23
		0.22
9 600	4 600	0.09
2 160	1 030	0.20
12 800	6 650	0.14
2 890	1 500	0.31
14 000	7 850	0.17
		0.44
3 150	1 770	0.42
		0.40
		0.37
19 500	11 300	0.26
		0.63
4 400	2 540	0.61
		0.59
		0.57
25 700	15 300	0.39
		1.10
5 750	3 450	0.97
		0.85
		0.73
29 100	17 800	0.54
6 550	4 000	1.24
		1.15

# AR2

## Ball bearings Set screw type

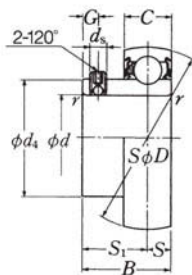

Shaft dia.	Bearing (*) number	Nominal dimensions									
		$d$	$D$	$B$	$C$	$r$	$S$	$S_1$	$G$	$d_s$	$d_4$
mm inch						mm inch min.	mm inch	mm	mm	mm	mm
45	<b>AR209</b>	45	85	41.5	22	1.5	11	30.5	8	M8×1	57.5
1 <sup>5</sup> / <sub>8</sub>	<b>AR209-110</b>	1.6250									
1 <sup>11</sup> / <sub>16</sub>	<b>AR209-111</b>	1.6875	3.3465	1.6339	0.8661	0.059	0.433	1.201	0.315	<sup>5</sup> / <sub>16</sub> -24UNF	2.2638
1 <sup>3</sup> / <sub>4</sub>	<b>AR209-112</b>	1.7500									
50	<b>AR210</b>	80	90	43	22	1.5	11	32	9	M8×1	62.4
1 <sup>13</sup> / <sub>16</sub>	<b>AR210-113</b>	1.8125									
1 <sup>7</sup> / <sub>8</sub>	<b>AR210-114</b>	1.8750	3.5433	1.6929	0.8661	0.059	0.433	1.260	0.354	<sup>5</sup> / <sub>16</sub> -24UNF	2.4567
1 <sup>15</sup> / <sub>16</sub>	<b>AR210-115</b>	1.9375									
2	<b>AR210-200</b>	2.0000									

Note (\*) If relubricatable type is needed, please order with "D1".

<b>Basic load ratings</b>		<b>Mass</b>
<b>N lbf</b>		<b>kg lb</b>
dynamic $C_r$	static $C_{0r}$	
32 500	20 400	0.61
		1.54
7 350	4 600	1.46
		1.39
35 000	23 200	0.70
		1.76
7 900	5 200	1.68
		1.59
		1.50

## Ball bearings Eccentric locking collar type

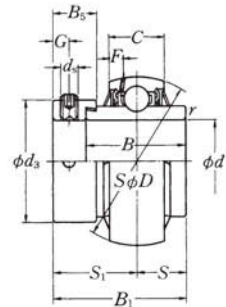

Shaft dia. mm inch	Bearing (1) number	Nominal dimensions										
		<i>d</i>	<i>D</i>	<i>B</i> <sub>1</sub>	<i>B</i>	<i>C</i>	<i>r</i> mm inch min.	<i>S</i>	<i>S</i> <sub>1</sub>	<i>G</i>	<i>d</i> <sub>s</sub>	<i>d</i> <sub>3</sub>
20 3/4	UEL204D1W3	20	47	43.7	34.2	17	1	17.1	26.6	4.8	M6×0.75	33
	UEL204-012D1W3	0.7500	1.8504	1.720	1.3465	0.6693	0.039	0.673	1.047	0.189	1/4-28UNF	1.299
25 13/16 7/8 15/16	UEL205D1W3	25	52	44.4	34.9	17	1	17.45	26.9	4.8	M6×0.75	38
	UEL205-013D1W3	0.8125										
	UEL205-014D1W3	0.8750	2.0472	1.748	1.3740	0.6693	0.039	0.687	1.059	0.189	1/4-28UNF	1.496
	UEL205-015D1W3	0.9375										
1	UEL205-100D1W3	1.0000										
30 1 1/16 1 1/8 1 3/16 1 1/4	UEL206D1W3	30	62	48.4	36.5	19	1	18.25	30.1	6	M8×1	44.5
	UEL206-101D1W3	1.0625										
	UEL206-102D1W3	1.1250	2.4409	1.906	1.4370	0.7480	0.039	0.719	1.185	0.236	5/16-24UNF	1.752
	UEL206-103D1W3	1.1875										
	UEL206-104D1W3	1.2500										
35 1 1/4 1 5/16 1 3/8 1 7/16	UEL207D1W3	35	72	51.1	37.6	20	1.5	18.8	32.3	6.8	M10×1.25	55.5
	UEL207-104D1W3	1.2500										
	UEL207-105D1W3	1.3125	2.8346	2.012	1.4803	0.7874	0.059	0.740	1.272	0.268	3/8-24UNF	2.185
	UEL207-106D1W3	1.3750										
	UEL207-107D1W3	1.4375										
40 1 1/2 1 9/16	UEL208D1W3	40	80	56.3	42.8	21	1.5	21.4	34.9	6.8	M10×1.25	60
	UEL208-108D1W3	1.5000	3.1496	2.217	1.6850	0.8268	0.059	0.843	1.374	0.268	3/8-24UNF	2.362
	UEL208-109D1W3	1.5625										
45 1 5/8 1 11/16 1 3/4	UEL209D1W3	45	85	56.3	42.8	22	1.5	21.4	34.9	6.8	M10×1.25	63.5
	UEL209-110D1W3	1.6250										
	UEL209-111D1W3	1.6875	3.3465	2.217	1.6850	0.8661	0.059	0.843	1.374	0.268	3/8-24UNF	2.500
	UEL209-112D1W3	1.7500										

Note (1) These numbers indicate relubricatable type. If maintenance free type is needed, please order without suffix "D1".

Nominal dimensions mm inch		Basic load ratings N lbf		Mass kg lb
$B_5$	$F$	dynamic $C_r$	static $C_{or}$	
13.5	4.7	12 800	6 650	0.23
0.531	0.185	2 890	1 500	0.45
13.5	4.5	14 000	7 850	0.27
0.531	0.177	3 150	1 770	0.61
				0.58
				0.55
				0.51
15.9	4.6	19 500	11 300	0.45
0.626	0.181	4 400	2 540	0.94
				0.89
				0.84
				0.80
17.5	4.6	25 700	15 300	0.60
0.689	0.181	5 750	3 450	1.45
				1.40
				1.35
				1.28
18.3	4.5	29 100	17 800	0.78
0.720	0.177	6 550	4 000	1.90
				1.82
18.3	4.9	32 500	20 400	0.80
0.720	0.193	7 350	4 600	2.05
				1.97
				1.88



## Ball bearings Eccentric locking collar type

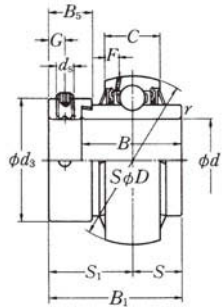

Shaft dia. mm inch	Bearing (1) number	Nominal dimensions										
		<i>d</i>	<i>D</i>	<i>B</i> <sub>1</sub>	<i>B</i>	<i>C</i>	<i>r</i> min.	<i>S</i>	<i>S</i> <sub>1</sub>	<i>G</i>	<i>d</i> <sub>s</sub>	<i>d</i> <sub>3</sub>
50	UEL210D1W3	50	90	62.7	49.2	24	1.5	24.6	38.1	6.8	M10x1.25	69.5
1 <sup>13</sup> / <sub>16</sub>	UEL210-113D1W3	1.8125										
1 <sup>7</sup> / <sub>8</sub>	UEL210-114D1W3	1.8750	3.5433	2.469	1.9370	0.9449	0.059	0.969	1.500	0.268	3/8-24UNF	2.736
1 <sup>15</sup> / <sub>16</sub>	UEL210-115D1W3	1.9375										
2	UEL210-200D1W3	2.0000										
55	UEL211D1W3	55	100	71.4	55.5	25	2	27.75	43.6	8	M10x1.25	76
2	UEL211-200D1W3	2.0000										
2 <sup>1</sup> / <sub>16</sub>	UEL211-201D1W3	2.0625	3.9370	2.811	2.1850	0.9843	0.079	1.093	1.717	0.315	3/8-24UNF	2.992
2 <sup>1</sup> / <sub>8</sub>	UEL211-202D1W3	2.1250										
2 <sup>3</sup> / <sub>16</sub>	UEL211-203D1W3	2.1875										
60	UEL212D1W3	60	110	77.8	61.9	27	2	30.95	46.8	8	M10x1.25	84
2 <sup>1</sup> / <sub>4</sub>	UEL212-204D1W3	2.2500										
2 <sup>5</sup> / <sub>16</sub>	UEL212-205D1W3	2.3125	4.3307	3.063	2.4370	1.0630	0.079	1.219	1.843	0.315	3/8-24UNF	3.307
2 <sup>3</sup> / <sub>8</sub>	UEL212-206D1W3	2.3750										
2 <sup>7</sup> / <sub>16</sub>	UEL212-207D1W3	2.4375										
65	UEL213D1W3	65	120	85.7	68.3	32	2	34.15	51.55	8.7	M10x1.25	97
2 <sup>1</sup> / <sub>2</sub>	UEL213-208D1W3	2.5000	4.7244	3.374	2.6890	1.2598	0.079	1.344	2.030	0.343	3/8-24UNF	3.819
2 <sup>9</sup> / <sub>16</sub>	UEL213-209D1W3	2.5625										
70	UEL214D1W3	70	125	85.7	68.3	33	2	34.15	51.55	8.7	M10x1.25	97
2 <sup>5</sup> / <sub>8</sub>	UEL214-210D1W3	2.6250										
2 <sup>1</sup> / <sub>16</sub>	UEL214-211D1W3	2.6875	4.9213	3.374	2.6890	1.2992	0.079	1.344	2.030	0.343	3/8-24UNF	3.819
2 <sup>3</sup> / <sub>4</sub>	UEL214-212D1W3	2.7500										
75	UEL215D1W3	75	130	92	74.6	34	2	37.3	54.7	8.7	M10x1.25	102
2 <sup>13</sup> / <sub>16</sub>	UEL215-213D1W3	2.8125										
2 <sup>7</sup> / <sub>8</sub>	UEL215-214D1W3	2.8750	5.1181	3.622	2.9370	1.3386	0.079	1.469	2.154	0.343	3/8-24UNF	4.016
2 <sup>15</sup> / <sub>16</sub>	UEL215-215D1W3	2.9375										
3	UEL215-300D1W3	3.0000										

Note (1) These numbers indicate relubricatable type. If maintenance free type is needed, please order without suffix "D1".

Nominal dimensions mm inch		Basic load ratings		Mass
$B_5$	$F$	N lbf		kg lb
		dynamic $C_r$	static $C_{or}$	
18.3	5.9	35 000	23 200	0.96 2.46
0.720	0.232	7 900	5 200	2.36 2.25 2.09
20.7	6.0	43 500	29 200	1.32 3.28
0.815	0.236	9 750	6 550	3.12 3.02 2.90
22.3	6.2	52 500	36 000	1.79 4.38
0.878	0.244	11 800	8 150	4.22 4.05 3.88
23.8	8.7	57 500	40 000	2.54 5.47
0.937	0.343	12 900	9 000	5.30
23.8	8.8	62 000	44 000	2.47 5.67
0.937	0.346	14 000	9 900	5.45 5.18
23.8	9.0	66 000	49 500	2.68 6.39
0.937	0.354	14 900	11 100	6.15 5.91 5.60

## Ball bearings Eccentric locking collar type

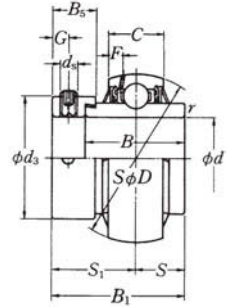

Shaft dia. mm inch	Bearing (1) number	Nominal dimensions										
		<i>d</i>	<i>D</i>	<i>B</i> <sub>1</sub>	<i>B</i>	<i>C</i>	$\frac{\text{mm}}{\text{inch}}$ <i>r</i> min.	<i>S</i>	<i>S</i> <sub>1</sub>	<i>G</i>	<i>d</i> <sub>s</sub>	<i>d</i> <sub>3</sub>
25	UEL305D1W3	25	62	46.8	34.9	20	1.5	16.7	30.1	6	M8×1	42.8
$\frac{13}{16}$	UEL305-013D1W3	0.8125										
$\frac{7}{8}$	UEL305-014D1W3	0.8750	2.4409	1.843	1.3740	0.7874	0.059	0.657	1.185	0.236	$\frac{5}{16}$ -24UNF	1.685
$\frac{15}{16}$	UEL305-015D1W3	0.9375										
1	UEL305-100D1W3	1.0000										
30	UEL306D1W3	30	72	50	36.5	23	1.5	17.5	32.5	6.7	M8×1	50
$1\frac{1}{16}$	UEL306-101D1W3	1.0625										
$1\frac{1}{8}$	UEL306-102D1W3	1.1250	2.8346	1.969	1.4370	0.9055	0.059	0.689	1.280	0.264	$\frac{5}{16}$ -24UNF	1.969
$1\frac{3}{16}$	UEL306-103D1W3	1.1875										
35	UEL307D1W3	35	80	51.6	38.1	25	2	18.3	33.3	6.7	M8×1	55
$1\frac{1}{4}$	UEL307-104D1W3	1.2500										
$1\frac{5}{16}$	UEL307-105D1W3	1.3125	3.1496	2.031	1.5000	0.9843	0.079	0.720	1.311	0.264	$\frac{5}{16}$ -24UNF	2.165
$1\frac{3}{8}$	UEL307-106D1W3	1.3750										
$1\frac{7}{16}$	UEL307-107D1W3	1.4375										
40	UEL308D1W3	40	90	57.1	41.3	27	2	19.8	37.3	8	M10×1.25	63.5
$1\frac{1}{2}$	UEL308-108D1W3	1.5000	3.5433	2.248	1.6260	1.0630	0.079	0.780	1.469	0.315	$\frac{3}{8}$ -24UNF	2.500
$1\frac{9}{16}$	UEL308-109D1W3	1.5625										
45	UEL309D1W3	45	100	58.7	42.9	29	2	19.8	38.9	8	M10×1.25	70
$1\frac{5}{8}$	UEL309-110D1W3	1.6250										
$1\frac{11}{16}$	UEL309-111D1W3	1.6875	3.9370	2.311	1.6890	1.1417	0.079	0.780	1.531	0.315	$\frac{3}{8}$ -24UNF	2.756
$1\frac{3}{4}$	UEL309-112D1W3	1.7500										
50	UEL310D1W3	50	110	66.6	49.2	32	2.5	24.6	42	8.7	M10×1.25	76.2
$1\frac{13}{16}$	UEL310-113D1W3	1.8125										
$1\frac{7}{8}$	UEL310-114D1W3	1.8750	4.3307	2.622	1.9370	1.2598	0.098	0.969	1.654	0.343	$\frac{3}{8}$ -24UNF	3.000
$1\frac{15}{16}$	UEL310-115D1W3	1.9375										

Note (1) These numbers indicate relubricatable type. If maintenance free type is needed, please order without suffix "D1".

Nominal dimensions mm inch		Basic load ratings		Mass
$B_5$	$F$	N lbf dynamic $C_r$	static $C_{or}$	kg lb
15.9	5.0	21 200	10 900	0.43
				1.09
0.626	0.197	4 750	2 460	1.05
				1.01
				0.96
17.5	5.9	26 700	15 000	0.69
				1.57
0.689	0.232	6 000	3 400	1.51
				1.45
17.5	6.8	33 500	19 100	0.78
				1.92
0.689	0.268	7 500	4 300	1.84
				1.77
				1.69
20.6	7.4	40 500	24 000	1.08
				2.58
0.811	0.291	9 150	5 400	2.49
20.6	7.4	53 000	32 000	1.40
				3.36
0.811	0.291	11 900	7 200	3.26
				3.15
22.2	8.1	62 000	38 500	1.84
				4.40
0.874	0.319	13 900	8 600	4.29
				4.15

## Ball bearings Eccentric locking collar type

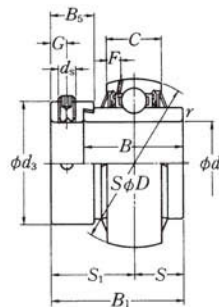

Shaft dia. mm inch	Bearing (1) number	Nominal dimensions										
		<i>d</i>	<i>D</i>	<i>B</i> <sub>1</sub>	<i>B</i>	<i>C</i>	<i>r</i> mm inch min.	<i>S</i>	<i>S</i> <sub>1</sub>	<i>G</i>	<i>d</i> <sub>s</sub>	<i>d</i> <sub>3</sub>
55 2	UEL311D1W3	55	120	73	55.6	34	2.5	27.8	45.2	8.7	M10x1.25	83
2 1/16	UEL311-200D1W3	2.0000										
2 1/8	UEL311-201D1W3	2.0625	4.7244	2.874	2.1890	1.3386	0.098	1.094	1.780	0.343	3/8-24UNF	3.268
2 3/16	UEL311-202D1W3	2.1250										
2 3/16	UEL311-203D1W3	2.1875										
60 2 1/4	UEL312D1W3	60	130	79.4	61.9	36	2.5	30.95	48.45	8.7	M10x1.25	89
2 5/16	UEL312-204D1W3	2.2500										
2 3/8	UEL312-205D1W3	2.3125	5.1181	3.126	2.4370	1.1473	0.098	1.219	1.907	0.343	3/8-24UNF	3.504
2 7/16	UEL312-206D1W3	2.3750										
2 7/16	UEL312-207D1W3	2.4375										
65 2 1/2	UEL313D1W3	65	140	85.7	65.1	39	2.5	32.55	53.15	10.3	M12x1.5	97
2 9/16	UEL313-208D1W3	2.5000	5.5118	3.374	2.5630	1.5354	0.098	1.281	2.093	0.406	1/2-20UNF	3.819
2 9/16	UEL313-209D1W3	2.5625										
70 2 5/8	UEL314D1W3	70	150	92.1	68.3	41	2.5	34.15	57.95	10.3	M12x1.5	102
2 11/16	UEL314-210D1W3	2.6250										
2 3/4	UEL314-211D1W3	2.6875	5.9055	3.626	2.6890	1.6142	0.098	1.344	2.281	0.406	1/2-20UNF	4.016
2 3/4	UEL314-212D1W3	2.7500										
75 2 13/16	UEL315D1W3	75	160	100	74.6	43	2.5	37.3	62.7	12.7	M16x1.5	113
2 7/8	UEL315-213D1W3	2.8125										
2 15/16	UEL315-214D1W3	2.8750	6.2992	3.937	2.9370	1.6929	0.098	1.469	2.469	0.500	5/8-18UNF	4.449
3	UEL315-215D1W3	2.9375										
3	UEL315-300D1W3	3.0000										
80 3 1/16	UEL316D1W3	80	170	106.4	81	45	2.5	40.5	65.9	12.7	M16x1.5	119
3 1/8	UEL316-301D1W3	3.0625										
3 3/8	UEL316-302D1W3	3.1250	6.6929	4.189	3.1890	1.7717	0.098	1.594	2.594	0.500	5/8-18UNF	4.685
3 3/16	UEL316-303D1W3	3.1875										

Note (1) These numbers indicate relubricatable type. If maintenance free type is needed, please order without suffix "D1".

Nominal dimensions mm inch		Basic load ratings		Mass
$B_5$	$F$	N lbf dynamic $C_r$	static $C_{or}$	kg lb
22.2	8.5	71 500	45 000	2.36
				5.58
0.874	0.335	16 100	10 100	5.39
				5.25
				5.08
23.9	9.0	82 000	52 000	2.94
				6.80
0.941	0.354	18 400	11 700	6.65
				6.48
				6.19
27	10.1	92 500	60 000	3.67
				8.49
1.063	0.398	20 800	13 400	8.27
30.2	10.5	104 000	68 000	4.40
				10.4
1.189	0.413	23 400	15 300	10.2
				9.96
31.8	11.0	113 000	77 000	5.34
				13.2
1.252	0.433	25 500	17 400	12.9
				12.7
				12.5
31.8	11.4	123 000	86 500	6.70
				14.9
1.252	0.449	27 600	19 500	14.8
				14.6

## Ball bearings Eccentric locking collar type

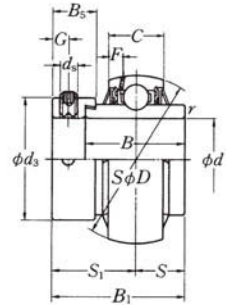

Shaft dia.	Bearing (*) number	Nominal dimensions										
		<i>d</i>	<i>D</i>	<i>B</i> <sub>1</sub>	<i>B</i>	<i>C</i>	<i>r</i>	<i>S</i>	<i>S</i> <sub>1</sub>	<i>G</i>	<i>d</i> <sub>s</sub>	<i>d</i> <sub>3</sub>
mm inch		mm inch min.										
85	UEL317D1W3	85	180	109.5	84.1	47	3	42.05	67.45	12.7	M16×1.5	127
3 3/4	UEL317-304D1W3	3.2500										
3 5/16	UEL317-305D1W3	3.3125	7.0866	4.311	3.3110	1.8504	0.118	1.656	2.656	0.500	5/8-18UNF	5.000
3 7/16	UEL317-307D1W3	3.4375										
90	UEL318D1W3	90	190	115.9	87.3	49	3	43.65	72.25	14.3	M20×1.5	133
3 7/16	UEL318-307D1W3	3.4375	7.4803	4.563	3.4370	1.9291	0.118	1.719	2.844	0.563	3/4-16UNF	5.236
3 1/2	UEL318-308D1W3	3.5000										
95	UEL319D1W3	95	200	122.3	93.7	51	3	38.9	83.4	14.3	M20×1.5	140
3 5/8	UEL319-310D1W3	3.6250										
3 11/16	UEL319-311D1W3	3.6875	7.8740	4.815	3.6890	2.0079	0.118	1.531	3.283	0.563	3/4-16UNF	5.512
3 3/4	UEL319-312D1W3	3.7500										
100	UEL320D1W3	100	215	128.6	100	55	3	50	78.6	14.3	M20×1.5	146
3 13/16	UEL320-313D1W3	3.8125										
3 7/8	UEL320-314D1W3	3.8750	8.4646	5.063	3.9370	2.1654	0.118	1.969	3.094	0.563	3/4-16UNF	5.748
3 15/16	UEL320-315D1W3	3.9375										
4	UEL320-400D1W3	4.0000										
105	UEL321D1W3	105	225	139.7	104.8	57	3	48.4	91.3	17.5	M20×1.5	157
110	UEL322D1W3	110	240	141.3	106.4	59	3	49.2	92.1	17.5	M20×1.5	168

Note (\*) These numbers indicate relubricatable type. If maintenance free type is needed, please order without suffix "D1".

Nominal dimensions mm inch		Basic load ratings		Mass
$B_5$	$F$	N lbf		kg lb
		dynamic $C_r$	static $C_{or}$	
31.8	12.0	133 000	97 000	8.00 18.0
1.252	0.472	29 800	21 800	17.7 17.0
36.5	12.3	143 000	107 000	9.10 20.7
1.437	0.484	32 000	24 100	20.2
36.5	12.8	153 000	119 000	10.4 23.4
1.437	0.504	34 500	26 600	23.0 22.6
36.5	13.5	173 000	141 000	13.0 28.5
1.437	0.531	39 000	31 500	28.0 27.6 27.0
42.8	13.9	184 000	153 000	14.6
42.8	13.9	205 000	179 000	17.2



## Ball bearings Eccentric locking collar type

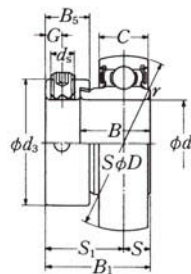

Shaft dia.	Bearing (1) number	Nominal dimensions										
		<i>d</i>	<i>D</i>	<i>B</i> <sub>1</sub>	<i>B</i>	<i>C</i>	<i>r</i>	<i>S</i>	<i>S</i> <sub>1</sub>	<i>G</i>	<i>d</i> <sub>s</sub>	<i>d</i> <sub>3</sub>
mm inch						mm inch						
						min.						
12	AEL201W3	12	40	28.6	19	12	0.6	6.5	22.1	4.8	M6×0.75	29
1/2	AEL201-008W3	0.5000	1.5748	1.126	0.7480	0.4724	0.024	0.256	0.870	0.189	1/4-28UNF	1.142
15	AEL202W3	15	40	28.6	19	12	0.6	6.5	22.1	4.8	M6×0.75	29
9/16	AEL202-009W3	0.5625	1.5748	1.126	0.7480	0.4724	0.024	0.256	0.870	0.189	1/4-28UNF	1.142
5/8	AEL202-010W3	0.6250										
17	AEL203W3	17	40	28.6	19	12	0.6	6.5	22.1	4.8	M6×0.75	29
1 1/16	AEL203-011W3	0.6875	1.5748	1.126	0.7480	0.4724	0.024	0.256	0.870	0.189	1/4-28UNF	1.142
20	AEL204W3	20	47	31	21.5	14	1	7.5	23.5	4.8	M6×0.75	33
3/4	AEL204-012W3	0.7500	1.8504	1.220	0.8465	0.5512	0.039	0.295	0.925	0.189	1/4-28UNF	1.299
25	AEL205W3	25	52	31	21.5	15	1	7.5	23.5	4.8	M6×0.75	38
1 3/16	AEL205-013W3	0.8125										
7/8	AEL205-014W3	0.8750	2.0472	1.220	0.8465	0.5906	0.039	0.295	0.925	0.189	1/4-28UNF	1.496
15/16	AEL205-015W3	0.9375										
1	AEL205-100W3	1.0000										
30	AEL206W3	30	62	35.7	23.8	16	1	9	26.7	6	M8×1	44.5
1 1/16	AEL206-101W3	1.0625										
1 1/8	AEL206-102W3	1.1250	2.4409	1.406	0.9370	0.6299	0.039	0.354	1.051	0.236	5/16-24UNF	1.752
1 3/16	AEL206-103W3	1.1875										
1 1/4	AEL206-104W3	1.2500										
35	AEL207W3	35	72	38.9	25.4	17	1.5	9.5	29.4	6.8	M10×1.25	55.5
1 1/4	AEL207-104W3	1.2500										
1 5/16	AEL207-105W3	1.3125	2.8346	1.531	1.0000	0.6693	0.059	0.374	1.157	0.268	3/8-24UNF	2.185
1 3/8	AEL207-106W3	1.3750										
1 7/16	AEL207-107W3	1.4375										
40	AEL208W3	40	80	43.7	30.2	18	1.5	11	32.7	6.8	M10×1.25	60
1 1/2	AEL208-108W3	1.5000	3.1496	1.720	1.1890	0.7087	0.059	0.433	1.287	0.268	3/8-24UNF	2.362
1 9/16	AEL208-109W3	1.5625										

Note (1) If relubricatable type is needed, please order with suffix "D1".

Nominal dimensions mm inch $B_5$	Basic load ratings		Mass kg lb
	dynamic $C_r$	static $C_{of}$	
13.6	9 600	4 600	0.12
0.535	2 160	1 030	0.26
13.6	9 600	4 600	0.11
0.535	2 160	1 030	0.26
			0.24
13.6	9 600	4 600	0.10
0.535	2 160	1 030	0.23
13.5	12 800	6 650	0.17
0.531	2 890	1 500	0.35
13.5	14 000	7 850	0.22
			0.51
0.531	3 150	1 770	0.48
			0.45
			0.42
15.9	19 500	11 300	0.31
			0.74
0.626	4 400	2 540	0.73
			0.66
			0.61
17.5	25 700	15 300	0.50
			1.15
0.689	5 750	3 450	1.10
			1.04
			0.98
18.3	29 100	17 800	0.66
			1.41
0.720	6 550	4 000	1.34
			1.34

## Ball bearings Eccentric locking collar type

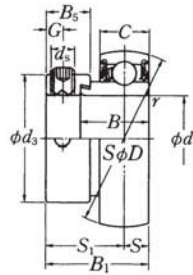

Shaft dia.	Bearing (°) number	Nominal dimensions										
		<i>d</i>	<i>D</i>	<i>B</i> <sub>1</sub>	<i>B</i>	<i>C</i>	<i>r</i>	<i>S</i>	<i>S</i> <sub>1</sub>	<i>G</i>	<i>d</i> <sub>s</sub>	<i>d</i> <sub>3</sub>
mm inch		mm inch										
		min.										
12	JEL201W3	12	40	28.6	19	13	0.6	6.5	22.1	4.8	M6×0.75	29
1/2	JEL201-008W3	0.5000	1.5748	1.126	0.7480	0.5118	0.024	0.256	0.870	0.189	1/4-28UNF	1.142
15	JEL202W3	15	40	28.6	19	13	0.6	6.5	22.1	4.8	M6×0.75	29
9/16	JEL202-009W3	0.5625	1.5748	1.126	0.7480	0.5118	0.024	0.256	0.870	0.189	1/4-28UNF	1.142
5/8	JEL202-010W3	0.6250										
17	JEL203W3	17	40	28.6	19	13	0.6	6.5	22.1	4.8	M6×0.75	29
1 1/16	JEL203-011W3	0.6875	1.5748	1.126	0.7480	0.5118	0.024	0.256	0.870	0.189	1/4-28UNF	1.142
20	JEL204W3	20	47	31	21.5	15	1	7.5	23.5	4.8	M6×0.75	33
3/4	JEL204-012W3	0.7500	1.8504	1.220	0.8465	0.5906	0.039	0.295	0.925	0.189	1/4-28UNF	1.299
25	JEL205W3	25	52	31	21.5	15	1	7.5	23.5	4.8	M6×0.75	38
1 3/16	JEL205-013W3	0.8125										
7/8	JEL205-014W3	0.8750	2.0472	1.220	0.8465	0.5906	0.039	0.295	0.925	0.189	1/4-28UNF	1.496
15/16	JEL205-015W3	0.9375										
1	JEL205-100W3	1.0000										
30	JEL206W3	30	62	35.7	23.8	18	1	9	26.7	6	M8×1	44.5
1 1/16	JEL206-101W3	1.0625										
1 1/8	JEL206-102W3	1.1250	2.4409	1.406	0.9370	0.7087	0.039	0.354	1.051	0.236	5/16-24UNF	1.752
1 3/16	JEL206-103W3	1.1875										
1 1/4	JEL206-104W3	1.2500										
35	JEL207W3	35	72	38.9	25.4	19	1.5	9.5	29.4	6.8	M10×1.25	55.5
1 1/4	JEL207-104W3	1.2500										
1 5/16	JEL207-105W3	1.3125	2.8346	1.531	1.0000	0.7480	0.059	0.374	1.157	0.268	3/8-24UNF	2.185
1 3/8	JEL207-106W3	1.3750										
1 7/16	JEL207-107W3	1.4375										
40	JEL208W3	40	80	43.7	30.2	22	1.5	11	32.7	6.8	M10×1.25	60
1 1/2	JEL208-108W3	1.5000	3.1496	1.720	1.1890	0.8661	0.059	0.433	1.287	0.268	3/8-24UNF	2.362
1 9/16	JEL208-109W3	1.5625										

Note (°) If relubricatable type is needed, please order with suffix "D1".

Nominal dimensions mm inch $B_5$	Basic load ratings		Mass kg lb
	dynamic $C_r$	static $C_{of}$	
13.6 0.535	9 600 2 160	4 600 1 030	0.12 0.25
13.6 0.535	9 600 2 160	4 600 1 030	0.10 0.24 0.22
13.6 0.535	9 600 2 160	4 600 1 030	0.09 0.20
13.5 0.531	12 800 2 890	6 650 1 500	0.16 0.37
13.5 0.531	14 000 3 150	7 850 1 770	0.19 0.50 0.47 0.44 0.41
15.9 0.626	19 500 4 400	11 300 2 540	0.33 0.78 0.73 0.69 0.64
17.5 0.689	25 700 5 750	15 300 3 450	0.50 1.22 1.16 1.11 1.05
18.3 0.720	29 100 6 550	17 800 4 000	0.65 1.53 1.46

## Ball bearings Eccentric locking collar type

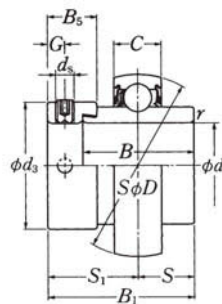

Shaft dia.  mm inch	Bearing <sup>(1)</sup> number	Nominal dimensions										
		<i>d</i>	<i>D</i>	<i>B</i> <sub>1</sub>	<i>B</i>	<i>C</i>	$\frac{\text{mm}}{\text{inch}}$ <i>r</i> min.	<i>S</i>	<i>S</i> <sub>1</sub>	<i>G</i>	<i>d</i> <sub>s</sub>	<i>d</i> <sub>3</sub>
20 $\frac{3}{4}$	REL204W3	20	47	43.7	34.2	15	1	17.1	26.6	4.8	M6x0.75	33.0
	REL204-012W3	0.7500	1.8504	1.720	1.3465	0.5906	0.039	0.673	1.047	0.189	$\frac{1}{4}$ -28UNF	1.299
25 $\frac{13}{16}$ $\frac{7}{8}$ $\frac{15}{16}$	REL205W3	25	52	44.4	34.9	15	1	17.45	26.9	4.8	M6x0.75	38.0
	REL205-013W3	0.8125										
	REL205-014W3	0.8750										
	REL205-015W3	0.9375	2.0472	1.748	1.3740	0.5906	0.039	0.687	1.059	0.189	$\frac{1}{4}$ -28UNF	1.496
1	REL205-100W3	1.0000										
30 $1\frac{1}{16}$ $1\frac{1}{8}$ $1\frac{3}{16}$ $1\frac{1}{4}$	REL206W3	30	62	48.4	36.5	18	1	18.25	30.1	6	M8x1	44.5
	REL206-101W3	1.0625										
	REL206-102W3	1.1250										
	REL206-103W3	1.1875	2.4409	1.906	1.4370	0.7087	0.039	0.719	1.185	0.236	$\frac{5}{16}$ -24UNF	1.752
	REL206-104W3	1.2500										
35 $1\frac{1}{4}$ $1\frac{5}{16}$ $1\frac{3}{8}$ $1\frac{7}{16}$	REL207W3	35	72	51.1	37.6	19	1.5	18.8	32.3	6.8	M10x1.25	55.5
	REL207-104W3	1.2500										
	REL207-105W3	1.3125										
	REL207-106W3	1.3750	2.8346	2.012	1.4803	0.7480	0.059	0.740	1.272	0.268	$\frac{3}{8}$ -24UNF	2.185
	REL207-107W3	1.4375										
40 $1\frac{1}{2}$ $1\frac{9}{16}$	REL208W3	40	80	56.3	42.8	22	1.5	21.4	34.9	6.8	M10x1.25	60.0
	REL208-108W3	1.5000										
	REL208-109W3	1.5625	3.1496	2.217	1.6850	0.8661	0.059	0.843	1.374	0.268	$\frac{3}{8}$ -24UNF	2.362
45 $1\frac{5}{8}$ $1\frac{11}{16}$ $1\frac{3}{4}$	REL209W3	45	85	56.3	42.8	22	1.5	21.4	34.9	6.8	M10x1.25	63.5
	REL209-110W3	1.6250										
	REL209-111W3	1.6875	3.3465	2.217	1.6850	0.8661	0.059	0.843	1.374	0.268	$\frac{3}{8}$ -24UNF	2.500
	REL209-112W3	1.7500										

Note <sup>(1)</sup> If relubricatable type is needed, please order with suffix "D1".

Nominal dimensions mm inch $B_5$	Basic load ratings		Mass kg lb
	dynamic $C_r$	static $C_{of}$	
13.5 0.531	12 800 2 890	6 650 1 500	0.22 0.43
13.5 0.531	14 000 3 150	7 850 1 770	0.26 0.59 0.56 0.53 0.49
15.9 0.626	19 500 4 400	11 300 2 540	0.39 0.92 0.87 0.82 0.78
17.5 0.689	25 700 5 750	15 300 3 450	0.59 1.41 1.36 1.31 1.24
18.3 0.720	29 100 6 550	17 800 4 000	0.76 1.88 1.80
18.3 0.720	32 500 7 350	20 400 4 600	0.78 2.01 1.93 1.84

## Ball bearings Eccentric locking collar type

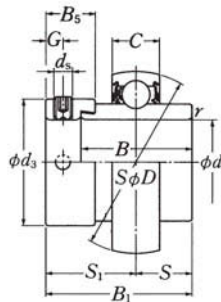

Shaft dia.	Bearing (1) number	Nominal dimensions										
		<i>d</i>	<i>D</i>	<i>B</i> <sub>1</sub>	<i>B</i>	<i>C</i>	$\frac{\text{mm}}{\text{inch}}$ <i>r</i>	<i>S</i>	<i>S</i> <sub>1</sub>	<i>G</i>	<i>d</i> <sub>s</sub>	<i>d</i> <sub>3</sub>
50	REL210W3	50	90	62.7	49.2	22	1.5	24.6	38.1	6.8	M10x1.25	69.5
1 <sup>13</sup> / <sub>16</sub>	REL210-113W3	1.8125										
1 <sup>7</sup> / <sub>8</sub>	REL210-114W3	1.8750	3.5433	2.469	1.9370	0.8661	0.059	0.969	1.500	0.268	3/8-24UNF	2.736
1 <sup>15</sup> / <sub>16</sub>	REL210-115W3	1.9375										
2	REL210-200W3	2.0000										
55	REL211W3	55	100	71.4	55.5	24	2	27.75	43.6	8	M10x1.25	76
2	REL211-200W3	2.0000										
2 <sup>1</sup> / <sub>16</sub>	REL211-201W3	2.0625	3.9370	2.811	2.1850	0.9449	0.079	1.093	1.717	0.315	3/8-24UNF	2.992
2 <sup>1</sup> / <sub>8</sub>	REL211-202W3	2.1250										
2 <sup>3</sup> / <sub>16</sub>	REL211-203W3	2.1875										
60	REL212W3	60	110	77.8	61.9	27	2	30.95	46.8	8	M10x1.25	84
2 <sup>1</sup> / <sub>4</sub>	REL212-204W3	2.2500										
2 <sup>5</sup> / <sub>16</sub>	REL212-205W3	2.3125	4.3307	3.063	2.4370	1.0630	0.079	1.219	1.843	0.315	3/8-24UNF	3.307
2 <sup>3</sup> / <sub>8</sub>	REL212-206W3	2.3750										
2 <sup>7</sup> / <sub>16</sub>	REL212-207W3	2.4375										

Note (1) If relubricatable type is needed, please order with suffix "D1".

Nominal dimensions mm inch $B_5$	Basic load ratings		Mass kg lb
	dynamic $C_r$	static $C_{of}$	
18.3	35 000	23 200	0.96 2.42
0.720	7 900	5 200	2.32 2.21 2.05
20.7	43 500	29 200	1.28 3.21
0.815	9 750	6 550	3.05 2.95 2.83
22.3	52 500	36 000	1.83 4.29
0.878	11 800	8 150	4.13 3.96 3.79



## Ball bearings Adapter type

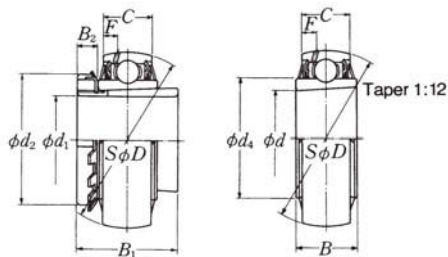

UK2··D1;H, HA, HE, HS

UK2··D1

Shaft dia.  mm inch	Bearing <sup>(1)</sup> ( <sup>2</sup> )( <sup>3</sup> ) number	Nominal dimensions									
		mm inch									
		<i>d</i>	<i>D</i>	<i>B</i>	<i>C</i>	<i>d</i> <sub>4</sub>	<i>d</i> <sub>1</sub>	<i>B</i> <sub>1</sub>	<i>B</i> <sub>2</sub>	<i>d</i> <sub>2</sub>	<i>F</i>
20  3/4	UK205D1;H2305X UK205D1;HE2305	25 0.9843	52 2.0472	23 0.9055	17 0.6693	33.9 1.335	20 3/4	35 1.378	8 0.315	38 1.496	4.5 0.177
25  7/8 1	UK206D1;H2306X UK206D1;HS2306 UK206D1;HE2306X	30 1.1811	62 2.4409	26 1.0236	19 0.7480	40.8 1.606	25 7/8 1	38 1.496	8 0.315	45 1.772	4.6 0.181
30  1 1/8	UK207D1;H2307X UK207D1;HS2307	35 1.3780	72 2.8346	29 1.1417	20 0.7874	46.8 1.843	30 1 1/8	43 1.693	9 0.354	52 2.047	4.6 0.181
35  1 1/4 1 3/8	UK208D1;H2308X UK208D1;HE2308X UK208D1;HS2308X	40 1.5748	80 3.1496	31 1.2205	21 0.8268	53 2.087	35 1 1/4 1 3/8	46 1.811	10 0.394	58 2.283	4.5 0.177
40  1 7/16 1 1/2 1 5/8	UK209D1;H2309X UK209D1;HA2309 UK209D1;HE2309X UK209D1;HS2309X	45 1.7717	85 3.3465	31 1.2205	22 0.8661	57.5 2.264	40 1 7/16 1 1/2 1 5/8	50 1.969	11 0.433	65 2.559	4.9 0.193
45  1 5/8 1 11/16 1 3/4	UK210D1;H2310X UK210D1;HS2310 UK210D1;HA2310 UK210D1;HE2310X	50 1.9685	90 3.5433	32 1.2598	24 0.9449	62.4 2.457	45 1 5/8 1 11/16 1 3/4	55 2.165	12 0.472	70 2.756	5.9 0.232
50  1 7/8 1 15/16 2	UK211D1;H2311X UK211D1;HS2311 UK211D1;HA2311 UK211D1;HE2311XY	55 2.1654	100 3.9370	35 1.3780	25 0.9843	69 2.717	50 1 7/8 1 15/16 2	59 2.323	12 0.472	75 2.953	6.0 0.236
55  2 1/8	UK212D1;H2312X UK212D1;HS2312	60 2.3622	110 4.3307	38 1.4961	27 1.0630	77 3.031	55 2 1/8	62 2.441	13 0.512	80 3.150	6.2 0.244

Notes (1) These numbers indicate relubricatable type. If maintenance free type is needed, please order without suffix "D1".

(2) Adapter number with suffix "X" means a narrow slot type adapter sleeve.

In this case the lock washer with the straight inner prong should be used.

(3) For HE2311XY, screw thread pitch different from the standard is applied, because of the thin thread section of sleeve. To distinguish it, a suffix "Y" is added.

<b>Basic load ratings</b>		<b>Mass</b>
<b>N lbf</b>		<b>kg lb</b>
dynamic $C_r$	static $C_{or}$	
14 000	7 850	0.23
3 150	1 770	0.57
19 500	11 300	0.36
4 400	2 540	0.86
		0.78
25 700	15 300	0.55
5 750	3 450	1.30
29 100	17 800	0.74
6 550	4 000	1.77
		1.63
32 500	20 400	0.80
		2.01
7 350	4 600	1.93
		1.76
35 000	23 200	0.94
		2.38
7 900	5 200	2.28
		2.18
43 500	29 200	1.22
		2.96
9 750	6 550	2.84
		2.70
52 500	36 000	1.54
11 800	8 150	3.60

## Ball bearings Adapter type

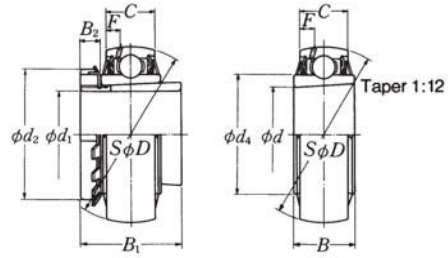

UK2...D1;H, HA, HE, HS

UK2...D1

Shaft dia.  mm inch	Bearing <sup>(1)(2)</sup> number	Nominal dimensions									
		mm inch									
		<i>d</i>	<i>D</i>	<i>B</i>	<i>C</i>	<i>d</i> <sub>4</sub>	<i>d</i> <sub>1</sub>	<i>B</i> <sub>1</sub>	<i>B</i> <sub>2</sub>	<i>d</i> <sub>2</sub>	<i>F</i>
60 2 <sup>3</sup> / <sub>16</sub> 2 <sup>1</sup> / <sub>4</sub> 2 <sup>3</sup> / <sub>8</sub>	UK213D1;H2313X UK213D1;HA2313 UK213D1;HE2313X UK213D1;HS2313X	65 2.5591	120 4.7244	40 1.5748	32 1.2598	82.5 3.248	60 2 <sup>3</sup> / <sub>16</sub> 2 <sup>1</sup> / <sub>4</sub> 2 <sup>3</sup> / <sub>8</sub>	65 2.559	14 0.551	85 3.346	8.7 0.343
65 2 <sup>7</sup> / <sub>16</sub> 2 <sup>1</sup> / <sub>2</sub>	UK215D1;H2315X UK215D1;HA2315 UK215D1;HE2315X	75 2.9528	130 5.1181	44 1.7323	34 1.3386	93 3.661	65 2 <sup>7</sup> / <sub>16</sub> 2 <sup>1</sup> / <sub>2</sub>	73 2.874	15 0.591	98 3.858	9.0 0.354
70 2 <sup>11</sup> / <sub>16</sub> 2 <sup>3</sup> / <sub>4</sub>	UK216D1;H2316X UK216D1;HA2316 UK216D1;HE2316X	80 3.1496	140 5.5118	45 1.7717	35 1.3780	98.1 3.862	70 2 <sup>11</sup> / <sub>16</sub> 2 <sup>3</sup> / <sub>4</sub>	78 3.071	17 0.669	105 4.134	9.5 0.374
75 2 <sup>15</sup> / <sub>16</sub> 3	UK217D1;H2317X UK217D1;HA2317X UK217D1;HE2317X	85 3.3465	150 5.9055	46 1.8110	36 1.4173	106.4 4.189	75 2 <sup>15</sup> / <sub>16</sub> 3	82 3.228	18 0.709	110 4.331	10.1 0.398
80 3 <sup>3</sup> / <sub>16</sub>	UK218D1;H2318X UK218D1;HA2318X	90 3.5433	160 6.2992	47 1.8504	37 1.4567	111.6 4.394	80 3 <sup>3</sup> / <sub>16</sub>	86 3.386	18 0.709	120 4.724	9.8 0.386

Notes <sup>(1)</sup> These numbers indicate relubricatable type. If maintenance free type is needed, please order without suffix "D1".

<sup>(2)</sup> Adapter number with suffix "X" means a narrow slot type adapter sleeve.  
In this case the lock washer with the straight inner prong should be used.

<b>Basic load ratings</b>		<b>Mass</b>
<b>N lbf</b>		<b>kg lb</b>
dynamic $C_r$	static $C_{or}$	
57 500	40 000	2.00
		4.86
12 900	9 000	4.70
		4.38
66 000	49 500	2.56
		6.04
14 900	11 100	5.84
72 500	53 000	3.23
		7.38
16 300	11 900	7.14
83 500	64 000	3.93
		8.73
18 700	14 300	8.46
96 000	71 500	4.51
21 600	16 100	11.0

## Ball bearings Adapter type

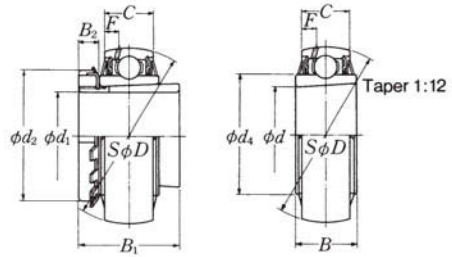

UK3...D1;H, HA, HE, HS

UK3...D1

Shaft dia.  mm inch	Bearing <sup>(1)</sup> ( <sup>2</sup> )( <sup>3</sup> ) number	Nominal dimensions									
		mm inch									
		<i>d</i>	<i>D</i>	<i>B</i>	<i>C</i>	<i>d</i> <sub>4</sub>	<i>d</i> <sub>1</sub>	<i>B</i> <sub>1</sub>	<i>B</i> <sub>2</sub>	<i>d</i> <sub>2</sub>	<i>F</i>
20 3/4	UK305D1;H2305X UK305D1;HE2305	25 0.9843	62 2.4409	26 1.0236	20 0.7874	36.8 1.449	20 3/4	35 1.378	8 0.315	38 1.496	5.0 0.197
25 7/8 1	UK306D1;H2306X UK306D1;HS2306 UK306D1;HE2306X	30 1.1811	72 2.8346	29 1.1417	23 0.9055	44.9 1.768	25 7/8 1	38 1.496	8 0.315	45 1.772	5.9 0.232
30 1 1/8	UK307D1;H2307X UK307D1;HS2307	35 1.3780	80 3.1496	33 1.2992	25 0.9843	49.4 1.945	30 1 1/8	43 1.693	9 0.354	52 2.047	6.8 0.268
35 1 1/4 1 3/8	UK308D1;H2308X UK308D1;HE2308X UK308D1;HS2308X	40 1.5748	90 3.5433	34 1.3386	27 1.0630	56 2.205	35 1 1/4 1 3/8	46 1.811	10 0.394	58 2.283	7.4 0.291
40 1 7/16 1 1/2 1 5/8	UK309D1;H2309X UK309D1;HA2309 UK309D1;HE2309X UK309D1;HS2309X	45 1.7717	100 3.9370	37 1.4567	29 1.1417	63.5 2.500	40 1 7/16 1 1/2 1 5/8	50 1.969	11 0.433	65 2.559	7.4 0.291
45 1 5/8 1 11/16 1 3/4	UK310D1;H2310X UK310D1;HS2310 UK310D1;HA2310 UK310D1;HE2310X	50 1.9685	110 4.3307	41 1.6142	32 1.2598	70.6 2.780	45 1 5/8 1 11/16 1 3/4	55 2.165	12 0.472	70 2.756	8.1 0.319
50 1 7/8 1 15/16 2	UK311D1;H2311X UK311D1;HS2311 UK311D1;HA2311 UK311D1;HE2311XY	55 2.1654	120 4.7244	44 1.7323	34 1.3386	76.6 3.016	50 1 7/8 1 15/16 2	59 2.323	12 0.472	75 2.953	8.5 0.335
55 2 1/8	UK312D1;H2312X UK312D1;HS2312	60 2.3622	130 5.1181	47 1.8504	36 1.4173	82.7 3.256	55 2 1/8	62 2.441	13 0.512	80 3.150	9.0 0.354

Notes <sup>(1)</sup> These numbers indicate relubricatable type. If maintenance free type is needed, please order without suffix "D1".

<sup>(2)</sup> Adapter number with suffix "X" means a narrow slot type adapter sleeve.

In this case the lock washer with the straight inner prong should be used.

<sup>(3)</sup> For HE2311XY, screw thread pitch different from the standard is applied, because of the thin thread section of sleeve. To distinguish it, a suffix "Y" is added.

Basic load ratings		Mass
dynamic	static	kg lb
$C_r$	$C_{or}$	
21 200	10 900	0.36
4 750	2 460	0.81
26 700	15 000	0.59
6 000	3 400	1.37
		1.29
33 500	19 100	0.75
7 500	4 300	1.70
40 500	24 000	1.00
9 150	5 400	2.38
		2.25
53 000	32 000	1.28
		3.22
11 900	7 200	3.14
		2.97
62 000	38 500	1.72
		3.95
13 900	8 600	3.85
		3.74
71 500	45 000	2.06
		4.73
16 100	10 100	4.60
		4.46
82 000	52 000	2.58
18 400	11 700	5.67

## Ball bearings Adapter type

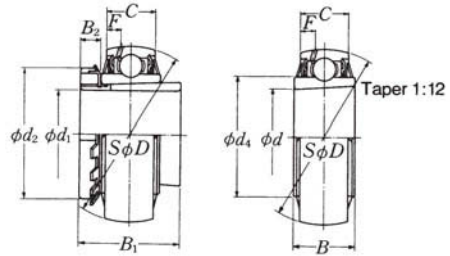

UK3...D1;H, HA, HE, HS

UK3...D1

Shaft dia. mm inch	Bearing <sup>(1)(2)</sup> number	Nominal dimensions									
		mm inch									
		<i>d</i>	<i>D</i>	<i>B</i>	<i>C</i>	<i>d</i> <sub>4</sub>	<i>d</i> <sub>1</sub>	<i>B</i> <sub>1</sub>	<i>B</i> <sub>2</sub>	<i>d</i> <sub>2</sub>	<i>F</i>
60 2 3/16 2 1/4 2 3/8	UK313D1;H2313X UK313D1;HA2313 UK313D1;HE2313X UK313D1;HS2313X	65 2.5591	140 5.5118	49 1.9291	39 1.5354	88.2 3.472	60 2 3/16 2 1/4 2 3/8	65 2.559	14 0.551	85 3.346	10.1 0.398
65 2 7/16 2 1/2	UK315D1;H2315X UK315D1;HA2315 UK315D1;HE2315X	75 2.9528	160 6.2992	55 2.1654	43 1.6929	101.3 3.988	65 2 7/16 2 1/2	73 2.874	15 0.591	98 3.858	11.0 0.433
70 2 11/16 2 3/4	UK316D1;H2316X UK316D1;HA2316 UK316D1;HE2316X	80 3.1496	170 6.6929	58 2.2835	45 1.7717	107.9 4.248	70 2 1/16 2 3/4	78 3.071	17 0.669	105 4.134	11.4 0.449
75 2 15/16 3	UK317D1;H2317X UK317D1;HA2317X UK317D1;HE2317X	85 3.3465	180 7.0866	60 2.3622	47 1.8504	114.4 4.504	75 2 15/16 3	82 3.228	18 0.709	110 4.331	12.0 0.472
80 3 3/16	UK318D1;H2318X UK318D1;HA2318X	90 3.5433	190 7.4803	64 2.5197	49 1.9291	120.9 4.760	80 3 3/16	86 3.386	18 0.709	120 4.724	12.3 0.484
85 3 1/4	UK319D1;H2319X UK319D1;HE2319X	95 3.7402	200 7.8740	67 2.6378	51 2.0079	127.5 5.020	85 3 1/4	90 3.543	19 0.748	125 4.921	12.8 0.504
90 3 3/16 3 1/2	UK320D1;H2320X UK320D1;HA2320 UK320D1;HE2320X	100 3.9370	215 8.4646	73 2.8740	55 2.1654	135.6 5.339	90 3 3/16 3 1/2	97 3.819	20 0.787	130 5.118	13.5 0.531
100	UK322D1;H2322X	110	240	80	59	151.7	100	105	21	145	13.9
110	UK324D1;H2324	120	260	86	63	165.2	110	112	22	155	16.0
115	UK326D1;H2326	130	280	90	67	178.3	115	121	23	165	16.9
125	UK328D1;H2328	140	300	95	71	190.4	125	131	24	180	17.7

Notes <sup>(1)</sup> These numbers indicate relubricatable type. If maintenance free type is needed, please order without suffix "D1".

<sup>(2)</sup> Adapter number with suffix "X" means a narrow slot type adapter sleeve.

In this case the lock washer with the straight inner prong should be used.

<b>Basic load ratings</b>		<b>Mass</b>
<b>N lbf</b>		<b>kg lb</b>
dynamic $C_r$	static $C_{or}$	
92 500	60 000	3.08 7.24
20 800	13 400	7.08 6.76
113 000	77 000	4.75
25 500	17 400	11.1 10.9
123 000	86 500	5.75
27 600	19 500	12.9 12.7
133 000	97 000	6.72
29 800	21 800	14.9 14.6
143 000	107 000	7.75
32 000	24 100	17.2
153 000	119 000	9.02
34 500	26 600	20.4
173 000	141 000	11.0
39 000	31 500	24.7 25.1
205 000	179 000	14.9
207 000	185 000	18.0
229 000	214 000	23.3
253 000	246 000	28.6



## Ball bearings Adapter type

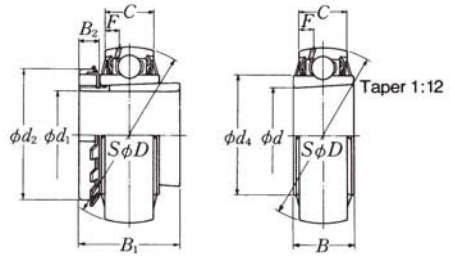

UKX...D1;H, HA, HE, HS

UKX...D1

Shaft dia. mm inch	Bearing <sup>(1)</sup> ( <sup>2</sup> )( <sup>3</sup> ) number	Nominal dimensions									
		mm inch									
		<i>d</i>	<i>D</i>	<i>B</i>	<i>C</i>	<i>d</i> <sub>4</sub>	<i>d</i> <sub>1</sub>	<i>B</i> <sub>1</sub>	<i>B</i> <sub>2</sub>	<i>d</i> <sub>2</sub>	<i>F</i>
20 3/4	UKX05D1;H2305X UKX05D1;HE2305	25 0.9843	62 2.4409	26 1.0236	19 0.7480	40.8 1.606	20 3/4	35 1.378	8 0.315	38 1.496	4.6 0.181
25 7/8	UKX06D1;H2306X UKX06D1;HS2306	30 1.1811	72 2.8346	29 1.1417	20 0.7874	46.8 1.843	25 7/8	38 1.496	8 0.315	45 1.772	4.6 0.181
1	UKX06D1;HE2306X						1				
30 1 1/8	UKX07D1;H2307X UKX07D1;HS2307	35 1.3780	80 3.1496	31 1.2205	21 0.8268	53 2.087	30 1 1/8	43 1.693	9 0.354	52 2.047	4.5 0.177
35 1 1/4	UKX08D1;H2308X UKX08D1;HE2308X	40 1.5748	85 3.3465	31 1.2205	22 0.8661	57.5 2.264	35 1 1/4	46 1.811	10 0.394	58 2.283	4.9 0.193
1 3/8	UKX08D1;HS2308X						1 3/8				
40 1 5/8	UKX09D1;H2309X UKX09D1;HA2309	45 1.7717	90 3.5433	32 1.2598	24 0.9449	62.4 2.457	40 1 5/8	50 1.969	11 0.433	65 2.559	5.9 0.232
1 1/2	UKX09D1;HE2309X						1 1/2				
1 5/8	UKX09D1;HS2309X						1 5/8				
45 1 7/8	UKX10D1;H2310X UKX10D1;HS2310	50 1.9685	100 3.9370	35 1.3780	25 0.9843	69 2.717	45 1 7/8	55 2.165	12 0.472	70 2.756	6.0 0.236
1 11/16	UKX10D1;HA2310						1 11/16				
1 3/4	UKX10D1;HE2310X						1 3/4				
50 1 7/8	UKX11D1;H2311X UKX11D1;HS2311	55 2.1654	110 4.3307	38 1.4961	27 1.0630	77 3.031	50 1 7/8	59 2.323	12 0.472	75 2.953	6.2 0.244
1 15/16	UKX11D1;HA2311						1 15/16				
2	UKX11D1;HE2311XY						2				
55 2 1/8	UKX12D1;H2312X UKX12D1;HS2312	60 2.3622	120 4.7244	40 1.5748	32 1.2598	82.5 3.248	55 2 1/8	62 2.441	13 0.512	80 3.150	8.7 0.343

Notes (1) These numbers indicate relubricatable type. If maintenance free type is needed, please order without suffix "D1".

(2) Adapter number with suffix "X" means a narrow slot type adapter sleeve. In this case the lock washer with the straight inner prong should be used.

(3) For HE2311XY, screw thread pitch different from the standard is applied, because of the thin thread section of sleeve. To distinguish it, a suffix "Y" is added.

Basic load ratings		Mass
dynamic	static	kg lb
$C_r$	$C_{or}$	
19 500	11 300	0.38
4 400	2 540	0.85
25 700	15 300	0.53
5 750	3 450	1.24
		1.16
29 100	17 800	0.75
6 550	4 000	1.70
32 500	20 400	0.85
7 350	4 600	2.01
		1.88
35 000	23 200	0.97
		2.32
7 900	5 200	2.24
		2.07
43 500	29 200	1.26
		3.09
9 750	6 550	2.99
		2.88
52 500	36 000	1.62
		3.84
11 800	8 150	3.72
		3.58
57 500	40 000	2.07
12 900	9 000	4.66

## Ball bearings Adapter type

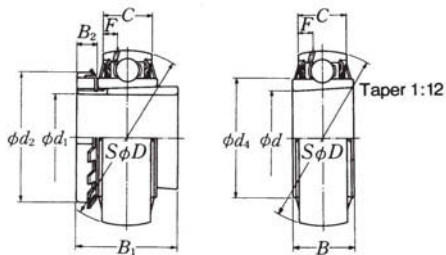

UKX...D1;H, HA, HE, HS

UKX...D1

Shaft dia.  mm inch	Bearing <sup>(1)(2)</sup> number	Nominal dimensions									
		mm inch									
		<i>d</i>	<i>D</i>	<i>B</i>	<i>C</i>	<i>d</i> <sub>4</sub>	<i>d</i> <sub>1</sub>	<i>B</i> <sub>1</sub>	<i>B</i> <sub>2</sub>	<i>d</i> <sub>2</sub>	<i>F</i>
60 2 <sup>3</sup> / <sub>16</sub> 2 <sup>1</sup> / <sub>4</sub> 2 <sup>3</sup> / <sub>8</sub>	UKX13D1;H2313X UKX13D1;HA2313 UKX13D1;HE2313X UKX13D1;HS2313X	65 2.5591	125 4.9213	42 1.6535	33 1.2992	87 3.425	60 2 <sup>3</sup> / <sub>16</sub> 2 <sup>1</sup> / <sub>4</sub> 2 <sup>3</sup> / <sub>8</sub>	65 2.559	14 0.551	85 3.346	8.8 0.346
65 2 <sup>7</sup> / <sub>16</sub> 2 <sup>1</sup> / <sub>2</sub>	UKX15D1;H2315X UKX15D1;HA2315 UKX15D1;HE2315X	75 2.9528	140 5.5118	45 1.7717	35 1.3780	98.1 3.862	65 2 <sup>7</sup> / <sub>16</sub> 2 <sup>1</sup> / <sub>2</sub>	73 2.874	15 0.591	98 3.858	9.5 0.374
70 2 <sup>11</sup> / <sub>16</sub> 2 <sup>3</sup> / <sub>4</sub>	UKX16D1;H2316X UKX16D1;HA2316 UKX16D1;HE2316X	80 3.1496	150 5.9055	46 1.8110	36 1.4173	106.4 4.189	70 2 <sup>11</sup> / <sub>16</sub> 2 <sup>3</sup> / <sub>4</sub>	78 3.071	17 0.669	105 4.134	10.1 0.398
75 2 <sup>15</sup> / <sub>16</sub> 3	UKX17D1;H2317X UKX17D1;HA2317X UKX17D1;HE2317X	85 3.3465	160 6.2992	47 1.8504	37 1.4567	111.6 4.394	75 2 <sup>15</sup> / <sub>16</sub> 3	82 3.228	18 0.709	110 4.331	9.8 0.386
80 3 <sup>3</sup> / <sub>16</sub>	UKX18D1;H2318X UKX18D1;HA2318X	90 3.5433	170 6.6929	49 1.9291	39 1.5354	118.2 4.654	80 3 <sup>3</sup> / <sub>16</sub>	86 3.386	18 0.709	120 4.724	10.5 0.413
90	UKX20D1;H2320X	100	190	57	44	131.3	90	97	20	130	11.3

Notes <sup>(1)</sup> These numbers indicate relubricatable type. If maintenance free type is needed, please order without suffix "D1".

<sup>(2)</sup> Adapter number with suffix "X" means a narrow slot type adapter sleeve.  
In this case the lock washer with the straight inner prong should be used.

<b>Basic load ratings</b>		<b>Mass</b>
<b>N lbf</b>		<b>kg lb</b>
dynamic $C_r$	static $C_{or}$	
62 000	44 000	2.19
		5.28
14 000	9 900	5.12
		4.79
72 500	53 000	3.25
		7.47
16 300	11 900	7.27
83 500	64 000	3.87
		8.79
18 700	14 300	8.56
96 000	71 500	4.53
		10.6
21 600	16 100	10.3
109 000	82 000	5.17
24 500	18 400	11.2
133 000	105 000	7.39

## Ball bearings Set screw type

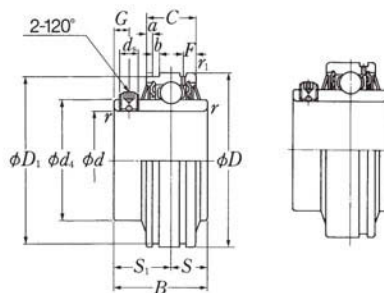

UCS...D1N

UCS...D1

Shaft dia. mm inch	Bearing (¹) number	Nominal dimensions									
		<i>d</i>	<i>D</i>	<i>B</i>	<i>C</i>	<i>r</i>	<i>r</i> <sub>1</sub>	<i>S</i>	<i>S</i> <sub>1</sub>	<i>G</i>	<i>d</i> <sub>s</sub>
		mm		inch		mm		inch		mm	
						min.	min.				
12 ½	UCS201LD1N	12	47	31	17	0.6	0.6	12.7	18.3	4.5	M5×0.8
	UCS201-008LD1N	0.5000	1.8504	1.2205	0.6693	0.024	0.024	0.500	0.720	0.177	No.10-32UNNF
15 9/16 5/8	UCS202LD1N	15	47	31	17	0.6	0.6	12.7	18.3	4.5	M5×0.8
	UCS202-009LD1N UCS202-010LD1N	0.5625 0.6250	1.8504	1.2205	0.6693	0.024	0.024	0.500	0.720	0.177	No.10-32UNNF
17 11/16	UCS203LD1N	17	47	31	17	0.6	0.6	12.7	18.3	4.5	M5×0.8
	UCS203-011LD1N	0.6875	1.8504	1.2205	0.6693	0.024	0.024	0.500	0.720	0.177	No.10-32UNNF
20 ¾	UCS204LD1N	20	47	31	17	1	0.6	12.7	18.3	4.5	M5×0.8
	UCS204-012LD1N	0.7500	1.8504	1.2205	0.6693	0.039	0.024	0.500	0.720	0.177	No.10-32UNNF
25 13/16 7/8 15/16	UCS205LD1N	25	52	34.1	17	1	0.6	14.3	19.8	5	M5×0.8
	UCS205-013LD1N	0.8125									
	UCS205-014LD1N	0.8750	2.0472	1.3425	0.6693	0.039	0.024	0.563	0.780	0.197	No.10-32UNNF
	UCS205-015LD1N	0.9375									
1	UCS205-100LD1N	1.0000									
30 1 1/16 1 1/8 1 3/16 1 1/4	UCS206LD1N	30	62	38.1	19	1	1	15.9	22.2	5	M6×0.75
	UCS206-101LD1N	1.0625									
	UCS206-102LD1N	1.1250	2.4409	1.5000	0.7480	0.039	0.039	0.626	0.874	0.197	¼-28UNF
	UCS206-103LD1N UCS206-104LD1N	1.1875 1.2500									
35 1 1/4 1 5/16 1 3/8 1 7/16	UCS207LD1N	35	72	42.9	20	1.5	1.5	17.5	25.4	6	M6×0.75
	UCS207-104LD1N	1.2500									
	UCS207-105LD1N	1.3125	2.8346	1.6890	0.7874	0.059	0.059	0.689	1.000	0.236	¼-28UNF
	UCS207-106LD1N UCS207-107LD1N	1.3750 1.4375									
40 1 1/2 1 9/16	UCS208LD1N	40	80	49.2	21	1.5	1.5	19	30.2	8	M8×1
	UCS208-108LD1N	1.5000	3.1496	1.9370	0.8268	0.059	0.059	0.748	1.189	0.315	5/16-24UNF
	UCS208-109LD1N	1.5625									
45 1 5/8 1 11/16 1 3/4	UCS209LD1N	45	85	49.2	22	1.5	1.5	19	30.2	8	M8×1
	UCS209-110LD1N	1.6250									
	UCS209-111LD1N	1.6875	3.3465	1.9370	0.8661	0.059	0.059	0.748	1.189	0.315	5/16-24UNF
	UCS209-112LD1N	1.7500									

Note (¹) These numbers indicate relubricatable type. If maintenance free type is needed, please order without suffix "D1N".

Nominal dimensions					Basic load ratings		Mass
$d_4$	$D_1$	mm inch		$F$	N lbf		kg lb
		$a$	$b$		dynamic $C_r$	static $C_{or}$	
29.6	44.6	3.1	1.5	4	12 800	6 650	0.21
1.1654	1.756	0.122	0.059	0.157	2 890	1 500	0.46
29.6	44.6	3.1	1.5	4	12 800	6 650	0.20
1.1654	1.756	0.122	0.059	0.157	2 890	1 500	0.44 0.42
29.6	44.6	3.1	1.5	4	12 800	6 650	0.18
1.1654	1.756	0.122	0.059	0.157	2 890	1 500	0.39
29.6	44.6	3.1	1.5	4	12 800	6 650	0.17
1.1654	1.756	0.122	0.059	0.157	2 890	1 500	0.39
33.9	49.73	3.2	1.5	4.1	14 000	7 850	0.20 0.53 0.51 0.46 0.44
1.3346	1.958	0.126	0.059	0.161	3 150	1 770	
40.8	59.61	3.2	2.05	4.2	19 500	11 300	0.34 0.82 0.77 0.73 0.66
1.6063	2.347	0.126	0.081	0.165	4 400	2 540	
46.8	68.81	3.3	2.05	5	25 700	15 300	0.48 1.21 1.15 1.08 1.01
1.8425	2.709	0.130	0.081	0.197	5 750	3 450	
53	76.81	3.4	2.05	5	29 100	17 800	0.65 1.52 1.46
2.0866	3.024	0.134	0.081	0.197	6 550	4 000	
57.5	81.81	3.5	2.05	5.1	32 500	20 400	0.70 1.76 1.68 1.57
2.2638	3.221	0.138	0.081	0.201	7 350	4 600	

## Ball bearings Set screw type

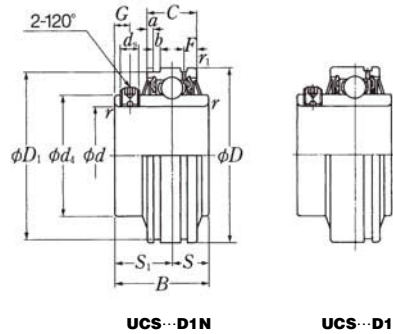

UCS...D1N

UCS...D1

Shaft dia.  mm inch	Bearing (*) number	Nominal dimensions									
		$d$	$D$	$B$	$C$	$r$		$S$	$S_1$	$G$	$d_s$
						mm	inch				
50	UCS210LD1N	50	90	51.6	24	1.5	1.5	19	32.6	9	M8x1
1 <sup>13</sup> / <sub>16</sub>	UCS210-113LD1N	1.8125									
1 <sup>7</sup> / <sub>8</sub>	UCS210-114LD1N	1.8750	3.5433	2.0315	0.9449	0.059	0.059	0.748	1.283	0.354	5/16"-24UNF
1 <sup>15</sup> / <sub>16</sub>	UCS210-115LD1N	1.9375									
2	UCS210-200LD1N	2.0000									
55	UCS211LD1N	55	100	55.6	25	2	2	22.2	33.4	9	M8x1
2	UCS211-200LD1N	2.0000									
2 <sup>1</sup> / <sub>16</sub>	UCS211-201LD1N	2.0625	3.9370	2.1890	0.9843	0.079	0.079	0.874	1.315	0.354	5/16"-24UNF
2 <sup>1</sup> / <sub>8</sub>	UCS211-202LD1N	2.1250									
2 <sup>3</sup> / <sub>16</sub>	UCS211-203LD1N	2.1875									
60	UCS212LD1N	60	110	65.1	27	2	2	25.4	39.7	10	M10x1.25
2 <sup>1</sup> / <sub>4</sub>	UCS212-204LD1N	2.2500									
2 <sup>5</sup> / <sub>16</sub>	UCS212-205LD1N	2.3125	4.3307	2.5630	1.0630	0.079	0.079	1.000	1.563	0.394	3/8"-24UNF
2 <sup>3</sup> / <sub>8</sub>	UCS212-206LD1N	2.3750									
2 <sup>7</sup> / <sub>16</sub>	UCS212-207LD1N	2.4375									
65	UCS213D1	65	120	65.1	32	2	2	25.4	39.7	10	M10x1.25
2 <sup>1</sup> / <sub>2</sub>	UCS213-208D1	2.5000	4.7244	2.5630	1.2598	0.079	0.079	1.000	1.563	0.394	3/8"-24UNF
2 <sup>9</sup> / <sub>16</sub>	UCS213-209D1	2.5625									
70	UCS214D1	70	125	74.6	33	2	2	30.2	44.4	12	M10x1.25
75	UCS215D1	75	130	77.8	34	2	2	33.3	44.5	12	M10x1.25
80	UCS216D1	80	140	82.6	35	2.5	2.5	33.3	49.3	12	M10x1.25
85	UCS217D1	85	150	85.7	36	2.5	2.5	34.1	51.6	12	M12x1.5
90	UCS218D1	90	160	96	37	2.5	2.5	39.7	56.3	12	M12x1.5

Note (\*) These numbers indicate relubricatable type. If maintenance free type is needed, please order without suffix "D1".

Nominal dimensions					Basic load ratings		Mass
$d_4$	$D_1$	mm inch		$F$	N lbf		kg lb
		$a$	$b$		dynamic $C_r$	static $C_{or}$	
62.4	86.79	3.7	2.85	5.6	35 000	23 200	0.78 2.03
2.4567	3.417	0.146	0.112	0.220	7 900	5 200	1.92 1.81 1.69
69	96.80	4.4	2.85	5.9	43 500	29 200	1.06 2.71
2.7165	3.811	0.173	0.112	0.232	9 750	6 550	2.60 2.46 2.34
77	106.81	4.4	2.85	6	52 500	36 000	1.48 3.78
3.0315	4.205	0.173	0.112	0.236	11 800	8 150	3.62 3.45 3.29
82.5	—	—	—	6.8	57 500	40 000	1.88 4.41
3.2480	—	—	—	0.268	12 900	9 000	4.24
87	—	—	—	7	62 000	44 000	2.17
93	—	—	—	7	66 000	49 500	2.43
98.1	—	—	—	7.5	72 500	53 000	2.89
106.4	—	—	—	7.5	83 500	64 000	3.47
111.6	—	—	—	7	96 000	71 500	4.24



## Ball bearings Set screw type

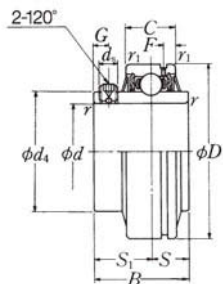

Shaft dia. mm inch	Bearing (1) number	Nominal dimensions									
		<i>d</i>	<i>D</i>	<i>B</i>	<i>C</i>	<i>r</i>	<i>r</i> <sub>1</sub>	<i>S</i>	<i>S</i> <sub>1</sub>	<i>G</i>	<i>d</i> <sub>s</sub>
						mm min.	inch min.				
25	<b>UCS305D1</b>	25	62	38	20	1.5	0.6	15	23	6	M6×0.75
<sup>13</sup> / <sub>16</sub>	<b>UCS305-013D1</b>	0.8125									
<sup>7</sup> / <sub>8</sub>	<b>UCS305-014D1</b>	0.8750	2.4409	1.4961	0.7874	0.059	0.024	0.591	0.906	0.236	<sup>1</sup> / <sub>4</sub> -28UNF
<sup>15</sup> / <sub>16</sub>	<b>UCS305-015D1</b>	0.9375									
1	<b>UCS305-100D1</b>	1.0000									
30	<b>UCS306D1</b>	30	72	43	23	1.5	1	17	26	6	M6×0.75
<sup>1</sup> / <sub>16</sub>	<b>UCS306-101D1</b>	1.0625									
<sup>1</sup> / <sub>8</sub>	<b>UCS306-102D1</b>	1.1250	2.8346	1.6929	0.9055	0.059	0.039	0.669	1.024	0.236	<sup>1</sup> / <sub>4</sub> -28UNF
<sup>3</sup> / <sub>16</sub>	<b>UCS306-103D1</b>	1.1875									
35	<b>UCS307D1</b>	35	80	48	25	2	1	19	29	8	M8×1
<sup>1</sup> / <sub>4</sub>	<b>UCS307-104D1</b>	1.2500									
<sup>5</sup> / <sub>16</sub>	<b>UCS307-105D1</b>	1.3125	3.1496	1.8898	0.9843	0.079	0.039	0.748	1.142	0.315	<sup>5</sup> / <sub>16</sub> -24UNF
<sup>3</sup> / <sub>8</sub>	<b>UCS307-106D1</b>	1.3750									
<sup>7</sup> / <sub>16</sub>	<b>UCS307-107D1</b>	1.4375									
40	<b>UCS308D1</b>	40	90	52	27	2	1	19	33	10	M10×1.25
<sup>1</sup> / <sub>2</sub>	<b>UCS308-108D1</b>	1.5000	3.5433	2.0472	1.0630	0.079	0.039	0.748	1.299	0.394	<sup>3</sup> / <sub>8</sub> -24UNF
<sup>9</sup> / <sub>16</sub>	<b>UCS308-109D1</b>	1.5625									
45	<b>UCS309D1</b>	45	100	57	29	2	1	22	35	10	M10×1.25
<sup>1</sup> / <sub>8</sub>	<b>UCS309-110D1</b>	1.6250									
<sup>11</sup> / <sub>16</sub>	<b>UCS309-111D1</b>	1.6875	3.9370	2.2441	1.1417	0.079	0.039	0.866	1.378	0.394	<sup>3</sup> / <sub>8</sub> -24UNF
<sup>3</sup> / <sub>4</sub>	<b>UCS309-112D1</b>	1.7500									
50	<b>UCS310D1</b>	50	110	61	32	2.5	1.5	22	39	12	M12×1.5
<sup>13</sup> / <sub>16</sub>	<b>UCS310-113D1</b>	1.8125									
<sup>7</sup> / <sub>8</sub>	<b>UCS310-114D1</b>	1.8750	4.3307	2.4016	1.2598	0.098	0.059	0.866	1.535	0.472	<sup>1</sup> / <sub>2</sub> -20UNF
<sup>15</sup> / <sub>16</sub>	<b>UCS310-115D1</b>	1.9375									
55	<b>UCS311D1</b>	55	120	66	34	2.5	1.5	25	41	12	M12×1.5
2	<b>UCS311-200D1</b>	2.0000									
<sup>2</sup> / <sub>16</sub>	<b>UCS311-201D1</b>	2.0625	4.7244	2.5984	1.3386	0.098	0.059	0.984	1.614	0.472	<sup>1</sup> / <sub>2</sub> -20UNF
<sup>2</sup> / <sub>8</sub>	<b>UCS311-202D1</b>	2.1250									
<sup>3</sup> / <sub>16</sub>	<b>UCS311-203D1</b>	2.1875									

Note (1) These numbers indicate relubricatable type. If maintenance free type is needed, please order without suffix "D1".

Nominal dimensions		Basic load ratings		Mass
$d_4$	$F$	N lbf		kg lb
mm	inch	dynamic $C_r$	static $C_{or}$	
36.8	4.3	21 200	10 900	0.37 0.94
1.4488	0.169	4 750	2 460	0.90 0.83 0.81
44.9	5.1	26 700	15 000	0.58 1.39
1.7677	0.201	6 000	3 400	1.33 1.28
49.4	5.3	33 500	19 100	0.74 1.77
1.9449	0.209	7 500	4 300	1.70 1.64 1.57
56	5.6	40 500	24 000	1.00 2.32
2.2047	0.220	9 150	5 400	2.23
63.5	5.8	53 000	32 000	1.33 3.17
2.5000	0.228	11 900	7 200	3.09 2.98
70.6	6.3	62 000	38 500	1.72 4.10
2.7795	0.248	13 900	8 600	3.99 3.85
76.6	6.5	71 500	45 000	2.15 5.14
3.0157	0.256	16 100	10 100	4.99 4.85 4.68

## Ball bearings Set screw type

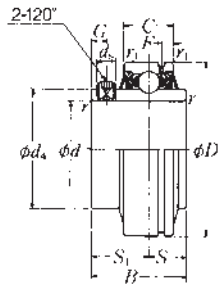

Shaft dia.  mm inch	Bearing (¹) number	Nominal dimensions									
		<i>d</i>	<i>D</i>	<i>B</i>	<i>C</i>	<i>r</i> mm min.	<i>r</i> <sub>1</sub> inch min.	<i>S</i>	<i>S</i> <sub>1</sub>	<i>G</i>	<i>d</i> <sub>s</sub>
60 2¼	<b>UCS312D1</b>	60	130	71	36	2.5	1.5	26	45	12	M12×1.5
2⅝	<b>UCS312-204D1</b>	2.2500									
2⅞	<b>UCS312-205D1</b>	2.3125	5.1181	2.7953	1.4173	0.098	0.059	1.024	1.772	0.472	½-20UNF
2⅞	<b>UCS312-206D1</b>	2.3750									
2⅞	<b>UCS312-207D1</b>	2.4375									
65 2½	<b>UCS313D1</b>	65	140	75	39	2.5	2	30	45	12	M12×1.5
2⅞	<b>UCS313-208D1</b>	2.5000	5.5118	2.9528	1.5354	0.098	0.079	1.181	1.772	0.472	½-20UNF
2⅞	<b>UCS313-209D1</b>	2.5625									
70 2⅝	<b>UCS314D1</b>	70	150	78	41	2.5	2	33	45	12	M12×1.5
2⅞	<b>UCS314-210D1</b>	2.6250									
2⅞	<b>UCS314-211D1</b>	2.6875	5.9055	3.0709	1.6142	0.098	0.079	1.299	1.772	0.472	½-20UNF
2¾	<b>UCS314-212D1</b>	2.7500									
75 2⅞	<b>UCS315D1</b>	75	160	82	43	2.5	2	32	50	14	M14×1.5
2⅞	<b>UCS315-213D1</b>	2.8125									
2⅞	<b>UCS315-214D1</b>	2.8750	6.2992	3.2283	1.6929	0.098	0.079	1.260	1.969	0.551	⅝-18UNF
2⅞	<b>UCS315-215D1</b>	2.9375									
3	<b>UCS315-300D1</b>	3.0000									
80 3⅜	<b>UCS316D1</b>	80	170	86	45	2.5	2	34	52	14	M14×1.5
3⅝	<b>UCS316-301D1</b>	3.0625									
3⅝	<b>UCS316-302D1</b>	3.1250	6.6929	3.3858	1.7717	0.098	0.079	1.339	2.047	0.551	⅝-18UNF
3⅝	<b>UCS316-303D1</b>	3.1875									
85 3¼	<b>UCS317D1</b>	85	180	96	47	3	2.5	40	56	16	M16×1.5
3⅝	<b>UCS317-304D1</b>	3.2500									
3⅝	<b>UCS317-305D1</b>	3.3125	7.0866	3.7795	1.8504	0.118	0.098	1.575	2.205	0.630	⅝-18UNF
3⅝	<b>UCS317-307D1</b>	3.4375									
90 3⅞	<b>UCS318D1</b>	90	190	96	49	3	2.5	40	56	16	M16×1.5
3⅞	<b>UCS318-307D1</b>	3.4375	7.4803	3.7795	1.9291	0.118	0.098	1.575	2.205	0.630	⅝-18UNF
3⅞	<b>UCS318-308D1</b>	3.5000									

Note (¹) These numbers indicate relubricatable type. If maintenance free type is needed, please order without suffix "D1".

Nominal dimensions		Basic load ratings		Mass
mm	inch	N lbf		kg lb
$d_4$	$F$	dynamic $C_r$	static $C_{or}$	
82.7	6.7	82 000	52 000	2.70 6.27
3.2559	0.264	18 400	11 700	6.10 5.89 5.72
88.2	7.5	92 500	60 000	3.37 7.63
3.4724	0.295	20 800	13 400	7.41
94.8	7.5	104 000	68 000	4.03 9.37
3.7323	0.295	23 400	15 300	9.13 8.91
101.3	7.7	113 000	77 000	4.88 11.4
3.9882	0.303	25 500	17 400	11.1 10.9 10.6
107.9	7.8	123 000	86 500	5.74 13.0
4.2480	0.307	27 600	19 500	12.7 12.5
114.4	8.2	133 000	97 000	6.88 15.7
4.5039	0.323	29 800	21 800	15.4 14.7
120.9	8.5	143 000	107 000	7.80 17.8
4.7598	0.335	32 000	24 100	17.4



Nominal dimensions			Basic load ratings		Mass
$D_1$	mm inch		N lbf		kg lb
	$a$	$b$	dynamic $C_r$	static $C_{or}$	
38.1 1.500	1.98 0.078	1.5 0.059	9 600 2 160	4 600 1 030	0.12 0.24
38.1 1.500	1.98 0.078	1.5 0.059	9 600 2 160	4 600 1 030	0.11 0.23 0.22
38.1 1.500	1.98 0.078	1.5 0.059	9 600 2 160	4 600 1 030	0.10 0.20
44.6 1.756	2.38 0.094	1.5 0.059	12 800 2 890	6 650 1 500	0.17 0.33
49.73 1.958	2.38 0.094	1.5 0.059	14 000 3 150	7 850 1 770	0.20 0.46 0.44 0.42 0.39
59.61 2.347	3.18 0.125	2.05 0.081	19 500 4 400	11 300 2 540	0.31 0.67 0.65 0.63 0.61
68.81 2.709	3.18 0.125	2.05 0.081	25 700 5 750	15 300 3 450	0.49 1.18 1.05 0.93 0.81
76.81 3.024	3.18 0.125	2.05 0.081	29 100 6 550	17 800 4 000	0.50 1.15 1.06

## Ball bearings Eccentric locking collar type

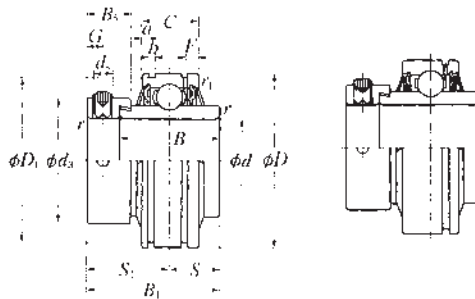

UELS...D1N

UELS...D1

Shaft dia.  mm inch	Bearing (1) number	Nominal dimensions										
		<i>d</i>	<i>D</i>	<i>B</i> <sub>1</sub>	<i>B</i>	<i>C</i>		<i>r</i> min.	<i>r</i> <sub>1</sub> min.	<i>S</i>	<i>S</i> <sub>1</sub>	<i>G</i>
						mm	inch					
20 3/4	UELS204LD1NW3	20	47	43.7	34.2	17	1	0.6	17.1	26.6	4.8	
	UELS204-012LD1NW3	0.7500	1.8504	1.720	1.3465	0.6693	0.039	0.024	0.673	1.047	0.189	
25 1 1/16 7/8 1 1/16	UELS205LD1NW3	25	52	44.4	34.9	17	1	0.6	17.45	26.9	4.8	
	UELS205-013LD1NW3	0.8125										
	UELS205-014LD1NW3	0.8750	2.0472	1.748	1.3740	0.6693	0.039	0.024	0.687	1.059	0.189	
	UELS205-015LD1NW3	0.9375										
1	UELS205-100LD1NW3	1.0000										
30 1 1/16 1 1/8 1 1/16 1 1/4	UELS206LD1NW3	30	62	48.4	36.5	19	1	1	18.25	30.1	6	
	UELS206-101LD1NW3	1.0625										
	UELS206-102LD1NW3	1.1250	2.4409	1.906	1.4370	0.7480	0.039	0.039	0.719	1.185	0.236	
	UELS206-103LD1NW3	1.1875										
1 1/4	UELS206-104LD1NW3	1.2500										
35 1 1/4 1 1/16 1 3/8 1 1/16	UELS207LD1NW3	35	72	51.1	37.6	20	1.5	1.5	18.8	32.3	6.8	
	UELS207-104LD1NW3	1.2500										
	UELS207-105LD1NW3	1.3125	2.8346	2.012	1.4803	0.7874	0.059	0.059	0.740	1.272	0.268	
	UELS207-106LD1NW3	1.3750										
1 1/16	UELS207-107LD1NW3	1.4375										
40 1 1/2 1 3/16	UELS208LD1NW3	40	80	56.3	42.8	21	1.5	1.5	21.4	34.9	6.8	
	UELS208-108LD1NW3	1.5000	3.1496	2.217	1.6850	0.8268	0.059	0.059	0.843	1.374	0.268	
	UELS208-109LD1NW3	1.5625										
45 1 7/8 1 1/16 1 3/4	UELS209LD1NW3	45	85	56.3	42.8	22	1.5	1.5	21.4	34.9	6.8	
	UELS209-110LD1NW3	1.6250										
	UELS209-111LD1NW3	1.6875	3.3465	2.217	1.6850	0.8661	0.059	0.059	0.843	1.374	0.268	
	UELS209-112LD1NW3	1.7500										
50 1 13/16 1 7/8 1 15/16 2	UCS210LD1NW3	50	90	62.7	49.2	24	1.5	1.5	24.6	38.1	6.8	
	UCS210-113LD1NW3	1.8125										
	UCS210-114LD1NW3	1.8750	3.5433	2.469	1.9370	0.9449	0.059	0.059	0.969	1.500	0.268	
	UCS210-115LD1NW3	1.9375										
2	UCS210-200LD1NW3	2.0000										

Note (1) These numbers indicate relubricatable type. If maintenance free type is needed, please order without suffix "D1".

Nominal dimensions							Basic load ratings		Mass
$d_s$	$d_3$	mm inch		$a$	$b$	$F$	N lbf		kg lb
		$B_5$	$D_1$				dynamic $C_r$	static $C_{or}$	
M6×0.75	33	13.5	44.6	3.1	1.5	4	12 800	6 650	0.23
¼-28UNF	1.299	0.531	1.756	0.122	0.059	0.157	2 890	1 500	0.45
M6×0.75	38	13.5	49.73	3.2	1.5	4.1	14 000	7 850	0.27
¼-28UNF	1.496	0.531	1.958	0.126	0.059	0.161	3 150	1 770	0.61 0.58 0.55 0.51
M8×1	44.5	15.9	59.61	3.2	2.05	4.2	19 500	11 300	0.41
⅝-24UNF	1.752	0.626	2.347	0.126	0.081	0.165	4 400	2 540	0.94 0.89 0.84 0.80
M10×1.25	55.5	17.5	68.81	3.3	2.05	5	25 700	15 300	0.60
⅜-24UNF	2.185	0.689	2.709	0.130	0.081	0.197	5 750	3 450	1.45 1.40 1.35 1.28
M10×1.25	60	18.3	76.81	3.4	2.05	5	29 100	17 800	0.79
⅜-24UNF	2.362	0.720	3.024	0.134	0.081	0.197	6 550	4 000	1.90 1.82
M10×1.25	63.5	18.3	81.81	3.5	2.05	5.1	32 500	20 400	0.85
⅜-24UNF	2.500	0.720	3.221	0.138	0.081	0.201	7 350	4 600	2.05 1.97 1.88
M10×1.25	69.5	18.3	86.79	3.7	2.85	5.6	35 000	23 200	0.98
⅜-24UNF	2.736	0.720	3.417	0.146	0.112	0.220	7 900	5 200	2.46 2.36 2.25 2.09



## Ball bearings Eccentric locking collar type

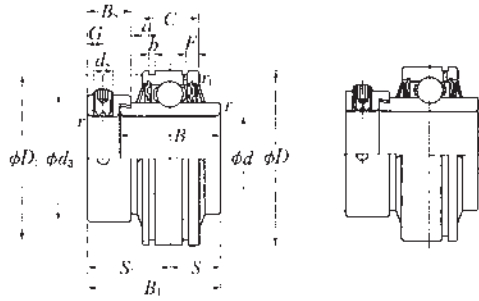

UELS...D1N

UELS...D1

Shaft dia.  mm inch	Bearing <sup>(1)</sup> number	Nominal dimensions									
		<i>d</i>	<i>D</i>	<i>B</i> <sub>1</sub>	<i>B</i>	<i>C</i>	mm	inch	<i>S</i>	<i>S</i> <sub>1</sub>	<i>G</i>
							<i>r</i>	<i>r</i> <sub>1</sub>			
55	<b>UELS211LD1NW3</b>	55	100	71.4	55.5	25	2	2	27.75	43.6	8
2	<b>UELS211-200LD1NW3</b>	2.0000									
2 1/16	<b>UELS211-201LD1NW3</b>	2.0625	3.9370	2.811	2.1850	0.9843	0.079	0.079	1.093	1.717	0.315
2 1/8	<b>UELS211-202LD1NW3</b>	2.1250									
2 3/16	<b>UELS211-203LD1NW3</b>	2.1875									
60	<b>UELS212LD1NW3</b>	60	110	77.8	61.9	27	2	2	30.95	46.8	8
2 1/4	<b>UELS212-204LD1W3</b>	2.2500									
2 5/16	<b>UELS212-205LD1W3</b>	2.3125	4.3307	3.063	2.4370	1.0630	0.079	0.079	1.219	1.843	0.315
2 3/8	<b>UELS212-206LD1W3</b>	2.3750									
2 7/16	<b>UELS212-207LD1W3</b>	2.4375									

Note <sup>(1)</sup> These numbers indicate relubricatable type. If maintenance free type is needed, please order without suffix "D1".

Nominal dimensions							Basic load ratings		Mass
$d_s$	$d_3$	mm inch		$a$	$b$	$F$	N lbf		kg lb
		$B_5$	$D_1$				dynamic $C_r$	static $C_{or}$	
M10×1.25	76	20.7	96.80	4.4	2.85	5.9	43 500	29 200	1.32 3.28
$\frac{3}{8}$ -24UNF	2.992	0.815	3.811	0.173	0.112	0.232	9 750	6 550	3.12 3.02 2.90
M10×1.25	84	22.3	106.81	4.4	2.85	6	52 500	36 000	1.93 4.50
$\frac{3}{8}$ -24UNF	3.307	0.878	4.205	0.173	0.112	0.236	11 800	8 150	4.34 4.17 4.00

## Ball bearings Eccentric locking collar type

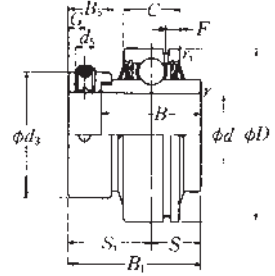

Shaft dia.  mm inch	Bearing (°) number	Nominal dimensions										
		<i>d</i>	<i>D</i>	<i>B</i> <sub>1</sub>	<i>B</i>	<i>C</i>	mm inch		<i>S</i>	<i>S</i> <sub>1</sub>	<i>G</i>	<i>d</i> <sub>s</sub>
							<i>r</i> min.	<i>r</i> <sub>1</sub> min.				
25 1 1/16	<b>UELS305D1W3</b>	25	62	46.8	34.9	20	1.5	0.6	16.7	30.1	6	M8×1
	<b>UELS305-013D1W3</b>	0.8125										
	<b>UELS305-014D1W3</b>	0.8750	2.4409	1.843	1.3740	0.7874	0.059	0.024	0.657	1.185	0.236	5/16-24UNF
	<b>UELS305-015D1W3</b>	0.9375										
1	<b>UELS305-100D1W3</b>	1.0000										
30 1 1/16	<b>UELS306D1W3</b>	30	72	50	36.5	23	1.5	1	17.5	32.5	6.7	M8×1
	<b>UELS306-101D1W3</b>	1.0625										
	<b>UELS306-102D1W3</b>	1.1250	2.8346	1.969	1.4370	0.9055	0.059	0.039	0.689	1.280	0.264	5/16-24UNF
	<b>UELS306-103D1W3</b>	1.1875										
35 1 1/4	<b>UELS307D1W3</b>	35	80	51.6	38.1	25	2	1	18.3	33.3	6.7	M8×1
	<b>UELS307-104D1W3</b>	1.2500										
	<b>UELS307-105D1W3</b>	1.3125	3.1496	2.031	1.5000	0.9843	0.079	0.039	0.720	1.311	0.264	5/16-24UNF
	<b>UELS307-106D1W3</b>	1.3750										
	<b>UELS307-107D1W3</b>	1.4375										
40 1 1/2	<b>UELS308D1W3</b>	40	90	57.1	41.3	27	2	1	19.8	37.3	8	M10×1.25
	<b>UELS308-108D1W3</b>	1.5000										
	<b>UELS308-109D1W3</b>	1.5625	3.5433	2.248	1.6260	1.0630	0.079	0.039	0.780	1.469	0.315	3/8-24UNF
45 1 5/8	<b>UELS309D1W3</b>	45	100	58.7	42.9	29	2	1	19.8	38.9	8	M10×1.25
	<b>UELS309-110D1W3</b>	1.6250										
	<b>UELS309-111D1W3</b>	1.6875	3.9370	2.311	1.6890	1.1417	0.079	0.039	0.780	1.531	0.315	3/8-24UNF
	<b>UELS309-112D1W3</b>	1.7500										
50 1 3/16	<b>UCS210D1W3</b>	50	110	66.6	49.2	32	2.5	1.5	24.6	42	8.7	M10×1.25
	<b>UCS210-113D1W3</b>	1.8125										
	<b>UCS210-114D1W3</b>	1.8750	4.3307	2.622	1.9370	1.2598	0.098	0.059	0.969	1.654	0.343	3/8-24UNF
	<b>UCS210-115D1W3</b>	1.9375										
55 2	<b>UELS311D1W3</b>	55	120	73	55.6	34	2.5	1.5	27.8	45.2	8.7	M10×1.25
	<b>UELS311-200D1W3</b>	2.0000										
	<b>UELS311-201D1W3</b>	2.0625										
	<b>UELS311-202D1W3</b>	2.1250	4.7244	2.874	2.1890	1.3386	0.098	0.059	1.094	1.780	0.343	3/8-24UNF
	<b>UELS311-203D1W3</b>	2.1875										

Note (°) These numbers indicate relubricatable type. If maintenance free type is needed, please order without suffix "D1".

Nominal dimensions			Basic load ratings		Mass
mm inch			N lbf		kg lb
$d_3$	$B_5$	$F$	dynamic $C_r$	static $C_{or}$	
42.8	15.9	4.3	21 200	10 900	0.45 1.13
1.685	0.626	0.169	4 750	2 460	1.09 1.05 1.00
50	17.5	5.1	26 700	15 000	0.71 1.62
1.969	0.689	0.201	6 000	3 400	1.56 1.50
55	17.5	5.3	33 500	19 100	0.83 1.99
2.165	0.689	0.209	7 500	4 300	1.91 1.84 1.76
63.5	20.6	5.6	40 500	24 000	1.12 2.67
2.500	0.811	0.220	9 150	5 400	2.58
70	20.6	5.8	53 000	32 000	1.50 3.26
2.756	0.811	0.228	11 900	7 200	3.37 3.26
76.2	22.2	6.3	62 000	38 500	1.93 4.55
3.000	0.874	0.248	13 900	8 600	4.44 4.30
83	22.2	6.5	71 500	45 000	2.42 5.76
3.268	0.874	0.256	16 100	10 100	5.57 5.43 5.26

## Ball bearings Eccentric locking collar type

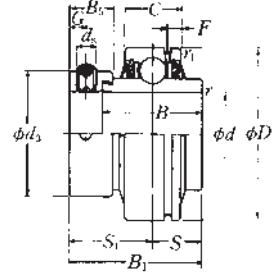

Shaft dia.	Bearing (1) number	Nominal dimensions										
		<i>d</i>	<i>D</i>	<i>B</i> <sub>1</sub>	<i>B</i>	<i>C</i>	mm inch		<i>S</i>	<i>S</i> <sub>1</sub>	<i>G</i>	<i>d</i> <sub>s</sub>
							<i>r</i> min.	<i>r</i> <sub>1</sub> min.				
60 2 1/4 2 3/16 2 3/8 2 7/16	UELS312D1W3 UELS312-204D1W3 UELS312-205D1W3 UELS312-206D1W3 UELS312-207D1W3	60 2.2500 2.3125 2.3750 2.4375	130	79.4	61.9	36	2.5	1.5	30.95	48.45	8.7	M10×1.25
65 2 1/2 2 9/16	UELS313D1W3 UELS313-208D1W3 UELS313-209D1W3	65 2.5000 2.5625	140	85.7	65.1	39	2.5	2	32.55	53.15	10.3	M12×1.5
70 2 5/8 2 1/2 2 3/4	UELS314D1W3 UELS314-210D1W3 UELS314-211D1W3 UELS314-212D1W3	70 2.6250 2.6875 2.7500	150	92.1	68.3	41	2.5	2	34.15	57.95	10.3	M12×1.5
75 2 9/16 2 7/8 2 15/16 3	UELS315D1W3 UELS315-213D1W3 UELS315-214D1W3 UELS315-215D1W3 UELS315-300D1W3	75 2.8125 2.8750 2.9375 3.0000	160	100	74.6	43	2.5	2	37.3	62.7	12.7	M16×1.5
80 3 1/16 3 1/8 3 1/4	UELS316D1W3 UELS316-301D1W3 UELS316-302D1W3 UELS316-303D1W3	80 3.0625 3.1250 3.1875	170	106.4	81	45	2.5	2	40.5	65.9	12.7	M16×1.5
85 3 1/4 3 9/16 3 11/16	UELS317D1W3 UELS317-304D1W3 UELS317-305D1W3 UELS317-307D1W3	85 3.2500 3.3125 3.4375	180	109.5	84.1	47	3	2.5	42.05	67.45	12.7	M16×1.5
90 3 7/16 3 1/2	UELS318D1W3 UELS318-307D1W3 UELS318-308D1W3	90 3.4375 3.5000	190	115.9	87.3	49	3	2.5	43.65	72.25	14.3	M20×1.5

Note (1) These numbers indicate relubricatable type. If maintenance free type is needed, please order without suffix "D1".

Nominal dimensions			Basic load ratings		Mass
$d_3$	$B_5$	$F$	N lbf		kg lb
			dynamic $C_r$	static $C_{or}$	
89	23.9	6.7	82 000	52 000	3.04
3.504	0.941	0.264	18 400	11 700	7.01
					6.86
					6.69
3.819	1.063	0.295	20 800	13 400	6.40
					3.79
					8.76
4.016	1.189	0.295	23 400	15 300	8.55
					4.54
					10.7
4.449	1.252	0.303	25 500	17 400	10.5
					5.50
					13.2
4.685	1.252	0.307	27 600	19 500	13.0
					6.89
					15.3
5.000	1.252	0.323	29 800	21 800	15.3
					8.21
					18.2
5.236	1.437	0.335	32 000	24 100	17.9
					9.34
					21.2
					20.7

## Ball bearings Eccentric locking collar type

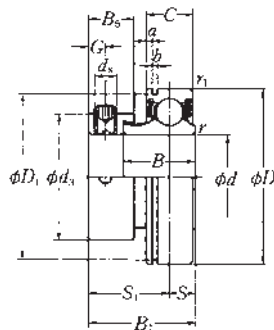

Shaft dia.  mm inch	Bearing number	Nominal dimensions										
		<i>d</i>	<i>D</i>	<i>B</i> <sub>1</sub>	<i>B</i>	<i>C</i>	mm inch		<i>S</i>	<i>S</i> <sub>1</sub>	<i>G</i>	<i>d</i> <sub>s</sub>
							<i>r</i> min.	<i>r</i> <sub>1</sub> min.				
12 1/2	<b>AELS201NW3</b>	12	40	28.6	19	12	0.6	0.6	6.5	22.1	4.8	M6×0.75
	<b>AELS201-008NW3</b>	0.5000	1.5748	1.126	0.7480	0.4724	0.024	0.024	0.256	0.870	0.189	1/4"-28UNF
15 9/16 5/8	<b>AELS202NW3</b>	15	40	28.6	19	12	0.6	0.6	6.5	22.1	4.8	M6×0.75
	<b>AELS202-009NW3</b>	0.5625	1.5748	1.126	0.7480	0.4724	0.024	0.024	0.256	0.870	0.189	1/4"-28UNF
	<b>AELS202-010NW3</b>	0.6250										
17 1 1/16	<b>AELS203NW3</b>	17	40	28.6	19	12	0.6	0.6	6.5	22.1	4.8	M6×0.75
	<b>AELS203-011NW3</b>	0.6875	1.5748	1.126	0.7480	0.4724	0.024	0.024	0.256	0.870	0.189	1/4"-28UNF
20 3/4	<b>AELS204NW3</b>	20	47	31	21.5	14	1	0.6	7.5	23.5	4.8	M6×0.75
	<b>AELS204-012NW3</b>	0.7500	1.8504	1.220	0.8465	0.5512	0.039	0.024	0.295	0.925	0.189	1/4"-28UNF
25 1 3/16 7/8 1 1/8 1	<b>AELS205NW3</b>	25	52	31	21.5	15	1	0.6	7.5	23.5	4.8	M6×0.75
	<b>AELS205-013NW3</b>	0.8125	2.0472	1.220	0.8465	0.5906	0.039	0.024	0.295	0.925	0.189	1/4"-28UNF
	<b>AELS205-014NW3</b>	0.8750										
	<b>AELS205-015NW3</b>	0.9375										
<b>AELS205-100NW3</b>	1.0000											
30 1 1/16 1 1/8 1 3/16 1 1/4	<b>AELS206NW3</b>	30	62	35.7	23.8	16	1	0.6	9	26.7	6	M8×1
	<b>AELS206-101NW3</b>	1.0625	2.4409	1.406	0.9370	0.6299	0.039	0.024	0.354	1.051	0.236	5/16"-24UNF
	<b>AELS206-102NW3</b>	1.1250										
	<b>AELS206-103NW3</b>	1.1875										
<b>AELS206-104NW3</b>	1.2500											
35 1 1/4 1 1/2 1 3/8 1 1/2	<b>AELS207NW3</b>	35	72	38.9	25.4	17	1.5	0.6	9.5	29.4	6.8	M10×1.25
	<b>AELS207-104NW3</b>	1.2500	2.8346	1.531	1.0000	0.6693	0.059	0.024	0.374	1.157	0.268	3/8"-24UNF
	<b>AELS207-105NW3</b>	1.3125										
	<b>AELS207-106NW3</b>	1.3750										
<b>AELS207-107NW3</b>	1.4375											
40 1 1/2 1 13/16	<b>AELS208NW3</b>	40	80	43.7	30.2	18	1.5	0.6	11	32.7	6.8	M10×1.25
	<b>AELS208-108NW3</b>	1.5000	3.1496	1.720	1.1890	0.7087	0.059	0.024	0.433	1.287	0.268	3/8"-24UNF
	<b>AELS208-109NW3</b>	1.5625										

Nominal dimensions					Basic load ratings		Mass
$d_3$	$D_1$	mm inch		$B_5$	N lbf		kg lb
		$a$	$b$		dynamic $C_r$	static $C_{or}$	
29	38.1	1.98	1.5	13.6	9 600	4 600	0.12
1.142	1.500	0.078	0.059	0.535	2 160	1 030	0.26
29	38.1	1.98	1.5	13.6	9 600	4 600	0.11
1.142	1.500	0.078	0.059	0.535	2 160	1 030	0.26 0.24
29	38.1	1.98	1.5	13.6	9 600	4 600	0.10
1.142	1.500	0.078	0.059	0.535	2 160	1 030	0.23
33	44.6	2.38	1.5	13.5	12 800	6 650	0.17
1.299	1.756	0.094	0.059	0.531	2 890	1 500	0.35
38	49.73	2.38	1.5	13.5	14 000	7 850	0.20
1.496	1.958	0.094	0.059	0.531	3 150	1 770	0.51 0.48 0.45 0.42
44.5	59.61	3.18	2.05	15.9	19 500	11 300	0.31
1.752	2.347	0.125	0.081	0.626	4 400	2 540	0.74 0.73 0.66 0.61
55.5	68.81	3.18	2.05	17.5	25 700	15 300	0.49
2.185	2.709	0.125	0.081	0.689	5 750	3 450	1.15 1.10 1.04 0.98
60	76.81	3.18	2.05	18.3	29 100	17 800	0.66
2.362	3.024	0.125	0.081	0.720	6 550	4 000	1.41 1.34



## Ball bearings Eccentric locking collar type

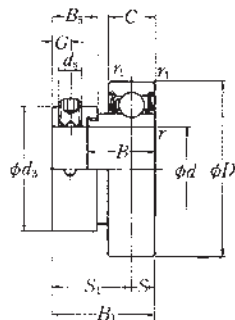

Shaft dia.  mm inch	Bearing number	Nominal dimensions										
		<i>d</i>	<i>D</i>	<i>B</i> <sub>1</sub>	<i>B</i>	<i>C</i>	mm inch		<i>S</i>	<i>S</i> <sub>1</sub>	<i>G</i>	<i>d</i> <sub>s</sub>
							<i>r</i> min.	<i>r</i> <sub>1</sub> min.				
12 1/2	<b>JELS201W3</b> <b>JELS201-008W3</b>	12 0.5000	40 1.5748	28.6 1.126	19 0.7480	13 0.5118	0.6 0.024	0.4 0.016	6.5 0.256	22.1 0.870	4.8 0.189	M6×0.75 1/4-28UNF
15 9/16 5/8	<b>JELS202W3</b> <b>JELS202-009W3</b> <b>JELS202-010W3</b>	15 0.5625 0.6250	40 1.5748	28.6 1.126	19 0.7480	13 0.5118	0.6 0.024	0.4 0.016	6.5 0.256	22.1 0.870	4.8 0.189	M6×0.75 1/4-28UNF
17 1 1/16	<b>JELS203W3</b> <b>JELS203-011W3</b>	17 0.6875	40 1.5748	28.6 1.126	19 0.7480	13 0.5118	0.6 0.024	0.4 0.016	6.5 0.256	22.1 0.870	4.8 0.189	M6×0.75 1/4-28UNF
20 3/4	<b>JELS204W3</b> <b>JELS204-012W3</b>	20 0.7500	47 1.8504	31 1.220	21.5 0.8465	15 0.5906	1 0.039	0.6 0.024	7.5 0.295	23.5 0.925	4.8 0.189	M6×0.75 1/4-28UNF
25 1 9/16 7/8 1 1/8 1	<b>JELS205W3</b> <b>JELS205-013W3</b> <b>JELS205-014W3</b> <b>JELS205-015W3</b> <b>JELS205-100W3</b>	25 0.8125 0.8750 0.9375 1.0000	52 2.0472	31 1.220	21.5 0.8465	15 0.5906	1 0.039	0.6 0.024	7.5 0.295	23.5 0.925	4.8 0.189	M6×0.75 1/4-28UNF
30 1 1/8 1 1/4	<b>JELS206W3</b> <b>JELS206-101W3</b> <b>JELS206-102W3</b> <b>JELS206-103W3</b> <b>JELS206-104W3</b>	30 1.0625 1.1250 1.1875 1.2500	62 2.4409	35.7 1.406	23.8 0.9370	18 0.7087	1 0.039	1 0.039	9 0.354	26.7 1.051	6 0.236	M8×1 5/16-24UNF
35 1 1/4 1 1/2 1 3/8 1 1/2	<b>JELS207W3</b> <b>JELS207-104W3</b> <b>JELS207-105W3</b> <b>JELS207-106W3</b> <b>JELS207-107W3</b>	35 1.2500 1.3125 1.3750 1.4375	72 2.8346	38.9 1.531	25.4 1.0000	19 0.7480	1.5 0.059	1.5 0.059	9.5 0.374	29.4 1.157	6.8 0.268	M10×1.25 3/8-24UNF
40 1 1/2 1 3/4	<b>JELS208W3</b> <b>JELS208-108W3</b> <b>JELS208-109W3</b>	40 1.5000 1.5625	80 3.1496	43.7 1.720	30.2 1.1890	22 0.8661	1.5 0.059	1.5 0.059	11 0.433	32.7 1.287	6.8 0.268	M10×1.25 3/8-24UNF

Nominal dimensions		Basic load ratings		Mass
mm	inch	N lbf		kg lb
$d_3$	$B_5$	dynamic $C_r$	static $C_{or}$	
29	13.6	9 600	4 600	0.13
1.142	0.535	2 160	1 030	0.26
29	13.6	9 600	4 600	0.13
1.142	0.535	2 160	1 030	0.26 0.24
29	13.6	9 600	4 600	0.10
1.142	0.535	2 160	1 030	0.22
33	13.5	12 800	6 650	0.18
1.299	0.531	2 890	1 500	0.42
38	13.5	14 000	7 850	0.20
1.496	0.531	3 150	1 770	0.54 0.51 0.48 0.44
44.5	15.9	19 500	11 300	0.34
1.752	0.626	4 400	2 540	0.84 0.79 0.75 0.70
55.5	17.5	25 700	15 300	0.53
2.185	0.689	5 750	3 450	1.29 1.24 1.18 1.12
60	18.3	29 100	17 800	0.71
2.362	0.720	6 550	4 000	1.64 1.57

## Ball bearings

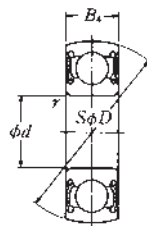

Shaft dia. mm	Bearing number	Nominal dimensions				Basic load ratings		Mass kg lb
		$d$	$D$ mm inch	$B_4$	$r$ min.	dynamic $C_r$ N lbf	static $C_{or}$ N lbf	
10	<b>CS200LLU</b>	10 0.3937	30 1.1811	9 0.3543	0.6 0.024	5 100 1 150	2 390 540	0.03 0.07
12	<b>CS201LLU</b>	12 0.4724	32 1.2598	10 0.3937	0.6 0.024	6 100 1 370	2 750 615	0.04 0.09
15	<b>CS202LLU</b>	15 0.5906	35 1.3780	11 0.4331	0.6 0.024	7 750 1 740	3 600 805	0.04 0.09
17	<b>CS203LLU</b>	17 0.6693	40 1.5748	12 0.4724	0.6 0.024	9 600 2 160	4 600 1 030	0.06 0.13
20	<b>CS204LLU</b>	20 0.7874	47 1.8504	14 0.5512	1 0.039	12 800 2 890	6 650 1 500	0.10 0.22
25	<b>CS205LLU</b>	25 0.9843	52 2.0472	15 0.5906	1 0.039	14 000 3 150	7 850 1 770	0.13 0.29
30	<b>CS206LLU</b>	30 1.1811	62 2.4409	16 0.6299	1 0.039	19 500 4 400	11 300 2 540	0.20 0.44
35	<b>CS207LLU</b>	35 1.3780	72 2.8346	17 0.6693	1.5 0.059	25 700 5 750	15 300 3 450	0.29 0.64
40	<b>CS208LLU</b>	40 1.5748	80 3.1496	18 0.7087	1.5 0.059	29 100 6 550	17 800 4 000	0.37 0.82

**NSK Sales Offices – Europe, Middle East and Africa**

**UK**

NSK UK Ltd.  
Northern Road, Newark  
Nottinghamshire NG24 2JF  
Tel. +44 (0) 1636 605123  
Fax +44 (0) 1636 643276  
info-uk@nsk.com

**France & Benelux**

NSK France S.A.S.  
Quartier de l'Europe  
2, rue Georges Guynemer  
78283 Guyancourt Cedex  
Tel. +33 (0) 1 30573939  
Fax +33 (0) 1 30570001  
info-fr@nsk.com

**Germany, Austria,  
Switzerland, Nordic**

NSK Deutschland GmbH  
Harkortstraße 15  
40880 Ratingen  
Tel. +49 (0) 2102 4810  
Fax +49 (0) 2102 4812290  
info-de@nsk.com

**Italy**

NSK Italia S.p.A.  
Via Garibaldi, 215  
20024 Garbagnate  
Milanese (MI)  
Tel. +39 02 995 191  
Fax +39 02 990 25 778  
info-it@nsk.com

**Middle East**

NSK Bearings Gulf Trading Co.  
JAFZA View 19, Floor 24 Office 2/3  
Jebel Ali Downtown,  
PO Box 262163  
Dubai, UAE  
Tel. +971 (0) 4 804 8205  
Fax +971 (0) 4 884 7227  
info-me@nsk.com

**Poland & CEE**

NSK Polska Sp. z o.o.  
Warsaw Branch  
Ul. Migdałowa 4/73  
02-796 Warszawa  
Tel. +48 22 645 15 25  
Fax +48 22 645 15 29  
info-pl@nsk.com

**Russia**

NSK Polska Sp. z o.o.  
Russian Branch  
Office 1 703, Bldg 29,  
18<sup>th</sup> Line of Vasilievskiy Ostrov,  
Saint-Petersburg, 199178  
Tel. +7 812 3325071  
Fax +7 812 3325072  
info-ru@nsk.com

**South Africa**

NSK South Africa (Pty) Ltd.  
25 Galaxy Avenue  
Linbro Business Park  
Sandton 2146  
Tel. +27 (011) 458 3600  
Fax +27 (011) 458 3608  
nsk-sa@nsk.com

**Spain**

NSK Spain, S.A.  
C/ Tarragona, 161 Cuerdo Bajo  
2ª Planta, 08014 Barcelona  
Tel. +34 93 2892763  
Fax +34 93 4335776  
info-es@nsk.com

**Turkey**

NSK Rulmanları Orta Doğu Tic. Ltd. Şti  
19 Mayıs Mah. Atatürk Cad.  
Ulya Engin İş Merkezi No: 68/3 Kat. 6  
P.K.: 34736 - Kozyatağı - İstanbul  
Tel. +90 216 4777111  
Fax +90 216 4777174  
turkey@nsk.com

Please also visit our website: [www.nskeurope.com](http://www.nskeurope.com) | Global NSK: [www.nsk.com](http://www.nsk.com)

